

Evoflex[®]

INSTALLATION AND USER'S INSTRUCTIONS

ART NOS. EB205, EB225, EB235, EB275, & EBE100

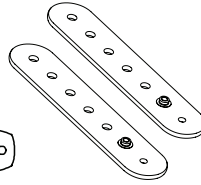
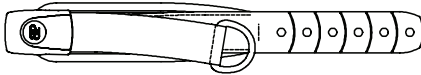

These instructions provide important information for the safe use and maintenance of the Bodypoint Evoflex pelvic positioning belt and optional Evoflex Belt Extender. Give these instructions to the user or their caregiver and review them to ensure that they are understood.

Optional Bodypoint belt mounting hardware may be used for mounting to wheelchairs and seating systems.

⚠ WARNING! Product should be installed and fitted by a qualified rehab technician.

INTENDED USE:

⚠ WARNING! This product should only be used for positioning a person in a wheelchair or work chair. It is NOT intended for use as a transportation safety device, as a personal restraint device, or in any other application where its failure could result in injury. Misuse of this product is unauthorized and unsafe.

⚠ WARNING! This pelvic positioning belt must be worn tightly fitted across the lower pelvis or thighs at all times. Have your seating specialist demonstrate its proper adjustment and use.

- A loose belt can allow the user to slip down and create a risk of strangulation.
- Accidental release of this belt can allow the user to slip down or fall from the wheelchair.
- A user's inability to self-release can be hazardous if the user slips down or is trapped in the wheelchair in an emergency.

If the user's physical or cognitive abilities prevent them from safely operating this belt, a caregiver must be present at all times during its use. Ensure that all caregivers know how to correctly adjust and unfasten the product.

⚠ WARNING! As with any new seating support, this product may change the way a person sits. Users must continue to practice regular pressure relief activities and skin integrity checks, not only where this product contacts the user, but also in primary pressure-bearing areas such as the

sacrum, legs, and buttocks. If increased skin redness or irritation occurs, discontinue use and consult your physician or seating specialist. Failure to do so may result in serious injury, such as pressure ulcers.

⚠ WARNING! If a serious incident occurs related to the use of this product, it should be reported to the manufacturer (Bodypoint, Inc.) and the local Competent Authority.

PERIODIC SAFETY AND PERFORMANCE CHECKS:

To ensure user safety, this product must be checked periodically for function and signs of wear. If the product does not function correctly or if significant wear is found in the buckles, mounting points, webbing, padding, or stitches, stop using it and contact your supplier for qualified repair or replacement by Bodypoint. Under no circumstance should this product be altered or repaired by unqualified persons — health and safety depend on it!



CLEANING: Machine wash, hot, 60°C (140°F). Do not bleach. Tumble dry, low temperature, or drip dry. Do not iron. (Placing the product inside a cloth bag during washing helps prevent scratches to the product and the machine.)

SCRAP/DISPOSAL: Product is made of materials which can be disposed of safely without special precautions at the end of its useful life.

WARRANTY: This product carries a limited lifetime warranty against defects in workmanship and materials arising under normal use by the original consumer. Contact your supplier or Bodypoint for warranty claims.

For more information on Bodypoint products, and a list of distributors outside the USA go to www.bodypoint.com.



Bodypoint Europe BV
Kerkstraat 29
7396 PD Terwolde
The Netherlands



Medical
Device

PACKAGE CONTENTS: Package may contain one or more of the following:

Evoflex pelvic positioning belt with:

- (2) M6 x 8 screws
- (2) M6 Low-profile flange nuts
- (2) Wave spring washers

(2) Evoflex Belt Extenders with:

- (2) M6 x 8mm screws
- (2) M6 Low-profile flange nuts

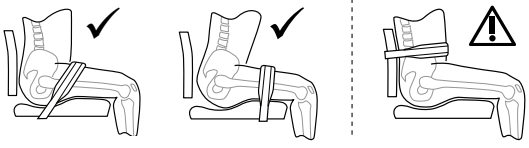
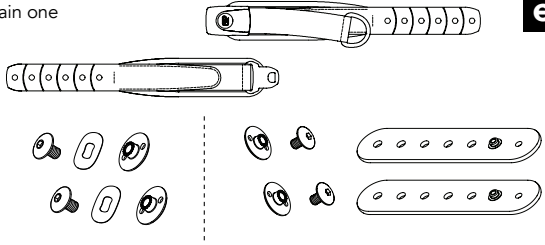

BELT POSITION

1. Based on clinical goals, determine the most effective position and angle for the belt. Determine whether putting pull strap on left or right side is best for user.
2. With the adjustment strap tightened, locate the desired mounting points on the seating system or wheelchair frame, then select from the mounting methods shown.
3. Add Evoflex Belt Extender if needed to reach mounting points.

CONTROLLING ROTATION

To increase tension and control rotation, use included wave spring washer. Omit wave spring washer to decrease tension and allow easier rotation.

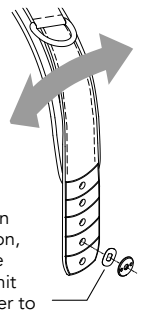

MOUNTING OPTIONS

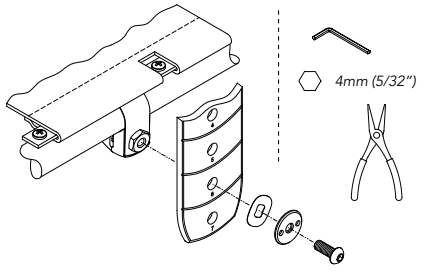

BAND CLAMP OR FRAME CLAMP
 (Requires Art. No. HW320 or HW310)
 Attach clamp to seat tube. Attach belt using the M6 screw included with the clamp.

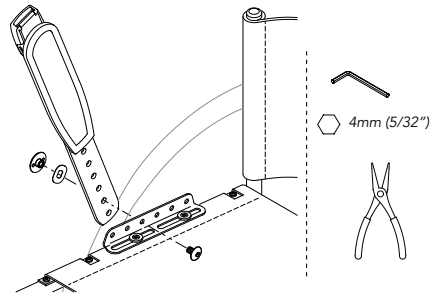

SEAT MOUNTING BRACKET
 (Requires Art. No. HW200-20 or -90)

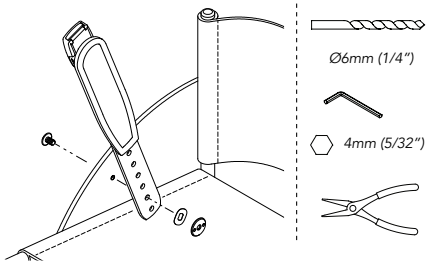

DIRECT MOUNTING TO SIDE GUARDS
 Drill 6mm (1/4") hole or use existing hole/slot to attach belt using included fasteners.

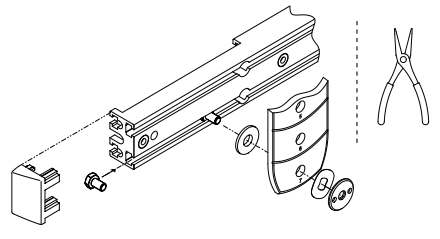

T-SLOT FASTENER KIT
 (Requires Art. No. HKA6-12 or HKA10-14)
 Use wave spring washer and low-profile flange nut from Evoflex kit with bolt and washer from T-Slot Fastener Kit.

EVOFLEX BELT EXTENDER INSTALLATION (OPTIONAL)

Attach Belt Extender to Evoflex. Spring washer not used.

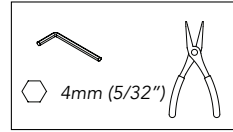

To prohibit belt rotation.
(Pin facing in)

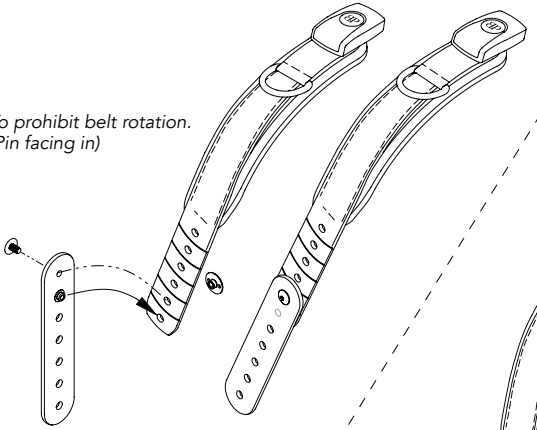

To allow belt rotation. (Pin facing out)

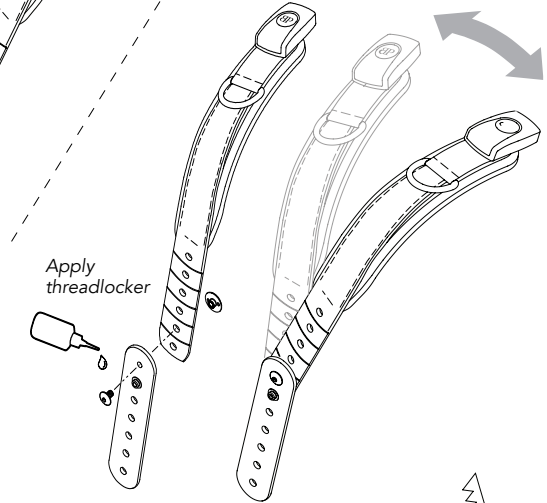

Apply
threadlocker



MOUNTING

Attach Belt Extender with Evoflex to wheelchair using one of the methods shown under Mounting Options. (Spring washer optional.)

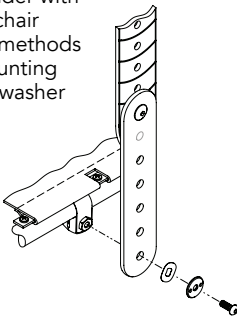

Cut to length as needed
using a saw. Ensure cut
location is as far away as
possible from mounting
hole being used.

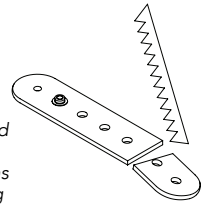

BELT ADJUSTMENT

When the belt is properly adjusted and tightened, it should fit snugly, with all slack removed, so that the user is secure. Use the pull strap for daily adjustments, such as to accommodate changes in clothing. If additional length adjustment is necessary to achieve a good fit or to remove the product for cleaning, this can be done at the end straps.

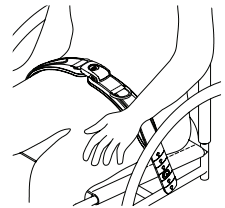

SAFETY CHECK

When properly positioned in wheelchair, have user lean forward and side to side to check fit. Check for:

1. Normal operation of buckle and adjustment straps.
2. **Comfort:** Look for areas of irritation.
3. **Position:** If too high or too low, adjust anchor points.
4. **Interference with other devices:** Relocate anchor points as necessary.
5. Move chair through full range of motion, including tilt, folding, and rolling. Check for any interference and relocate mounting points as necessary.

