



permobil Order Form - Progeo DUKE

Permobil Limited Unit 7, Polaris Centre, 41 Brownfields, Welwyn Garden City, Herts, AL7 1AN United Kingdom - Phone: +44 1484 722888

Date	UK (English)	
User	Company stamp	Rigid frame wheelchair
End user weight (kg)		£ 4236,00
Language user manual	Responsible	Retail price - VAT not included

Wheelchair measures		
Seat width (LS)	<input type="checkbox"/> 33 <input type="checkbox"/> 36 <input type="checkbox"/> 39 <input type="checkbox"/> 42 <input type="checkbox"/> 45 <input type="checkbox"/> 48	<small>The seat width is measured from the outer sides of the frame, while the distance between the two side guards is 1.5 cm wider.</small>
Seat depth (PS)	<input type="checkbox"/> 35 <input type="checkbox"/> 37,5 <input type="checkbox"/> 40 <input type="checkbox"/> 42,5 <input type="checkbox"/> 45 <input type="checkbox"/> 47,5 <input type="checkbox"/> 50	<small>The real seat depth, from the front part of the seat cloth to the backrest tube will be 1,5 cm more than the declared one.</small>
Footplate distance (DP) (cm) ±0.5cm - adjustment steps 1.5cm	(Real distance between seat and footplate) - IMPORTANT NOTICE! From the footplate to the floor minimum 4cm !! (Minimum Front height = DP + 4cm.)
Setting	☆ Standard <input type="checkbox"/> Prudential <input type="checkbox"/> Active	
Backrest Height (TS)	Std.Value 33,5(min 24.5-max 47) adjustment steps 1.5cm	
Camber	☆ 0° <input type="checkbox"/> 2° <input type="checkbox"/> 4°	

<p>Front frame</p> <p>☆ Carbon fibre frame, Angle 90° to the seat</p>	
--	--

<p>Front height - Tick the box with the required height</p> <p>The possible difference in height between HIGH frame and LOW frame is 3cm (with same fork, caster and assembly hole).</p>		
	 SPORT fork (H95)	 Small size fork (H115)
<p>LOW FRAME 90°</p> <p>Front height (min 44,5 - max 50)</p> <p>Footplate distance (min 34,5)</p> <div border="1" style="padding: 2px; margin-top: 5px; color: red;"> <p>U-TUBE Aluminium footplate Footplate distance (min 18 + max 35) DPmax = Front height - 10cm</p> </div>	<p style="text-align: center;"><i>Casters</i></p> <p>3" <input type="checkbox"/> ~45 <input type="checkbox"/> ~46</p> <p>4" <input type="checkbox"/> ~46 <input type="checkbox"/> ~47</p> <p>5" <input type="checkbox"/> ~48,5</p>	<p style="text-align: center;"><i>Casters</i></p> <p>3" <input type="checkbox"/> ~45,5 <input type="checkbox"/> ~47</p> <p>4" <input type="checkbox"/> ~46,5 <input type="checkbox"/> ~48 <input type="checkbox"/> ~49</p> <p>5" <input type="checkbox"/> ~49 <input type="checkbox"/> ~50</p>
<p>HIGH FRAME 90°</p> <p>Front height (min 47,5 - max 53)</p> <p>Footplate distance (min 37,5)</p> <div border="1" style="padding: 2px; margin-top: 5px; color: red;"> <p>U-TUBE Aluminium footplate Footplate distance (min 21 + max 38) DPmax = Front height - 10cm</p> </div>	<p style="text-align: center;"><i>Casters</i></p> <p>3" <input type="checkbox"/> ~48 <input type="checkbox"/> ~49</p> <p>4" <input type="checkbox"/> ~49 <input type="checkbox"/> ~50</p> <p>5" <input type="checkbox"/> ~51,5</p>	<p style="text-align: center;"><i>Casters</i></p> <p>3" <input type="checkbox"/> ~48,5 <input type="checkbox"/> ~50</p> <p>4" <input type="checkbox"/> ~49,5 <input type="checkbox"/> ~51 <input type="checkbox"/> ~52</p> <p>5" <input type="checkbox"/> ~52 <input type="checkbox"/> ~53</p>
<p>The real front-seat height could be slightly different from the chosen one considering it is affected by seat depth and rear seat height.</p>		
<p>Rear height</p> <p>Rear wheels 22" (min 36 - max 44)</p> <p>Rear wheels 24" (min 38 - max 46)</p> <p>Rear wheels 25" (min 39 - max 47)</p> <p>Rear wheels 26" (min 41 - max 48)</p> <p style="text-align: center;">The difference between Font Height and Rear Height must be in the 3 - 12 cm range.</p>		

Seat		
☆ Seat cloth with pocket (under seat)		
<input type="radio"/> Seat with tension straps	08883	224,00
<input type="radio"/> Carbon rigid seat	08336	475,00
<input type="radio"/> Pocket (under seat) [25x11x4,5]	08281	74,00

customer_support_uk@permobil.com - https://www.permobil.com/en-gb

Date Order User Address

CUSTOMIZE COLORS

① Fork colour

☆ Opaque black

- Bright silver
- Bright orange
- Bright anthracite
- Bright blue
- Pearl white
- Bright fuchsia
- Bright red
- Bright lime

08342 63,00

② Colour rear wheels

To be matched only with: Rear wheels Ultra-light Progeo - Standard! (22 - 24)

☆ Black

- Bright silver
- Bright orange
- Bright anthracite
- Bright blue
- Pearl white
- Bright fuchsia
- Bright red
- Bright lime

04692 63,00

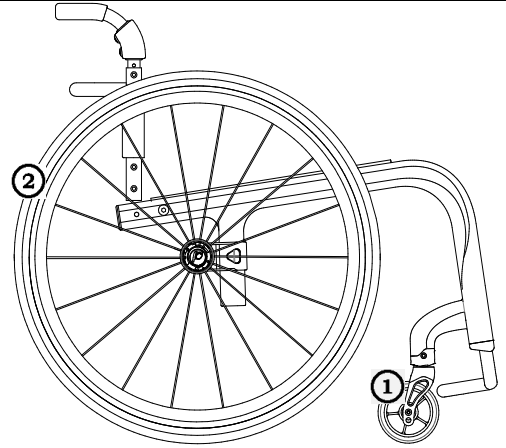

Rear wheels axle

☆ Aluminum rear wheels axle

Carbon fiber rear wheels axle

(Lightest configuration)

07647 148,00

Backrest adjustment and fixing system

☆ Backrest with double locking (upright and folded)

Backrest with upright locking system ONLY (no locking when folded)

Fixed back(non-folding back)

with rake adjustable from -4° to +16°

with rake adjustable from -4° to +16°

with rake adjustable from -4° to +16°

Backrest

☆ Adjustable velcro straps and padded transpiring upholstery

☆ Aluminium backrest

Titanium backrest

Carbon fibre backrest

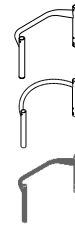

06811 189,00

04389 749,00

AIR Integrated posture backrest (NOT REMOVABLE)

Carbon shell - Lateral retaining 7,5cm

Depth adjustment ±1cm. - Angle adjustment ±10°

not available for seat width 48

1.047,00

H 28	H 34	H 40			
Backrest Height (TS) min 34 (.....)	Backrest Height (TS) min 38 (.....)	Backrest Height (TS) min 44 (.....)			
Lateral retaining wing A=high - R=regular					
A	R	A	R	A	R
<input type="checkbox"/>	<input type="checkbox"/>	<input type="checkbox"/>	<input type="checkbox"/>	<input type="checkbox"/>	<input type="checkbox"/>

Installation on:

☆ Backrest tubes

Aluminium backrest

Titanium backrest

Carbon fibre backrest

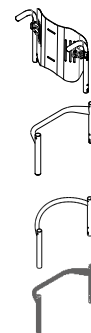

06811 189,00

04389 749,00

Handle tube

☆ Tubes with standard handle

Tubes with short handle

SPORT tubes Without push handles

Carbon fibre tubes with short handle

Weight reduction approx. 110gr.

04390 148,00

Not available with: Posture backrest PHYSIO - Posture backrest A I R

Folding handles



02958 252,00

Date Order User Address

Footplate

☆ Aluminium footplate. Rake not adjustable

☆ Aluminium footplate with plastic plate

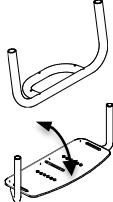
One piece aluminium footplate - Flip-up! FLIP-BACK! - rake and depth adjustable  09420 189,00

Aluminium footplate, rake and depth adjustable  04456 252,00

☆ Internal 2/3 Internal External 2/3 External

U-TUBE - Aluminium footplate, rake and depth adjustable  09853 224,00

LOW FRAME: minimum footplate distance 18 - maximum footplate distance 35
HIGH FRAME: minimum footplate distance 21 - maximum footplate distance 38

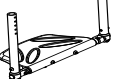
One piece Carbon fibre footplate. Rake adjustable  04110 372,00

☆ Internal External

Mudguard

☆ Carbon fibre mudguard

Carbon fibre Straight sideguard

Removable version  08921 126,00

Casters

☆ 4" Soft

3" Sport

5" Soft

3" Active Soft (wide) (Aluminium alloy rim) 06824 126,00

4" Active Sport (narrow) (Aluminium alloy rim) 01398 126,00

4" Active Soft (wide) (Aluminium alloy rim) 03943 126,00

5" Active Soft (wide) (Aluminium alloy rim) 07518 126,00

5" Pneumatic 10844 63,00

Rear wheels

☆ 24" Ultra-light Progeo - Standard!

22" Ultra-light Progeo - Standard!

25" Ultra-light Progeo - Standard! (colour: black)

26" Progeo - Standard! (colour: black)

24" ULTRA-LIGHT PROGEO KEY SPORT **Weight reduction approx. 450gr.** 04383 876,00

24" Ultra-light "Spinergy LX" 01685 876,00

24" Ultra-light "Spinergy LXL" Black hub and white spokes Hub and spokes black 07846 876,00

24" Ultra-light "Spinergy Flex rim" **Integrated aluminium/rubber handrim** 02270 1.374,00

25" Ultra-light "Spinergy LX" 02101 876,00

25" Ultra-light "Spinergy LXL" Black hub and white spokes 07847 876,00

26" Ultra-light "Spinergy LX" 02102 876,00

24" Off-road (aluminium handrim black) 01392 224,00

Rear wheel tyre

☆ High pressure tyre (22"-24"-25"-26")

High pressure profile tyre (24")







Marathon Plus (24"-25") **with anti-puncture protection** 01669 63,00



Anti-puncture - Colour Grey (22") 04181 98,00

Anti-puncture - Colour Black (24") 11083 126,00



Date	Order	User	Address
------------	-------------	------------	---------------



Handrim	Wheel distance <input checked="" type="checkbox"/> 3 cm <input type="checkbox"/> 4 cm			
<input checked="" type="checkbox"/> Aluminium	(22"-24"-25"-26")			
<input type="checkbox"/> Aluminium black SOFT-TOUCH	(24"-25")	(24" handrim, on 25" wheel is installed with spacers)	09170	126,00
<input type="checkbox"/> Chromed Steel	(24"-25")	(24" handrim, on 25" wheel is installed with spacers)	01684	148,00
<input type="checkbox"/> Titanium	(24"-25")	(24" handrim, on 25" wheel is installed with spacers)	00016	275,00
<input type="checkbox"/> Ultra Grepp	(24"-25")	(24" handrim, on 25" wheel is installed with spacers)	00017	315,00
<input type="checkbox"/> Max Grepp	(24"-25")	(24" handrim, on 25" wheel is installed with spacers)	00834	349,00
<input type="checkbox"/> Ergo Para	(24")		00632	349,00
<input type="checkbox"/> TOP FRICTION	(24"-25")	(24" handrim, on 25" wheel is installed with spacers)	11023	399,00
Oval countour with a rubber insert				
<input type="checkbox"/> NOVA H	(24"-25")	(24" handrim, on 25" wheel is installed with spacers)	11025	263,00
Ergonomic black profile				
<input type="checkbox"/> NOVA D	(24"-25")	(24" handrim, on 25" wheel is installed with spacers)	11026	286,00
Ergonomic profile with rubber coating (ideal for quadriplegics)				
<input type="checkbox"/> SURGE LT	(25")	Oval countour with a rubber insert	06427	360,00
<input type="checkbox"/> Quad (24")	(24")		00693	200,00
<input type="checkbox"/> Silicon cover for standard aluminium handrim		Available for measures (22" - 24" - 26")	04050	160,00

Wheel locks				
<input checked="" type="checkbox"/> Bent lever push to lock				
<input type="checkbox"/> Straight lever push to lock				
<input type="checkbox"/> Straight lever pull to lock				
<input type="checkbox"/> Sport brake			06428	126,00
<input type="checkbox"/> Brake with extension lever push to lock			01949	63,00
<input type="checkbox"/> Brake with extension lever pull to lock			03372	63,00

Armrests				
<input type="checkbox"/> Tubular armrests	(Swing away, removable and height adjustable armrest)		00694	252,00
<input type="checkbox"/> Removable armrest with carbon-fiber straight sideguard			09079	224,00

Accessories				
<input type="checkbox"/> Pad for front frame protectors			07058	52,00
<input type="checkbox"/> Backrest-seat connection cloth			10241	17,00
<input type="checkbox"/> Removable storage bag (with quick coupling)			09811	126,00

Optional 1				
<u>Only one optional devices for side can be chosen</u>				
<input type="checkbox"/> Transit wheels	Exclude the installation of Anti-tippers		03290	148,00
<input type="checkbox"/> Anti-tipper with rapid hookup	Exclude the installation of Transit wheels (inside rotation to reduce the encumbrance)		06821	126,00
	<input type="checkbox"/> Right		06822	126,00
	<input type="checkbox"/> Left			

Optional 2				
<input type="checkbox"/> Push handles for companion	(Removable and height adjustable)		03645	177,00
<input type="checkbox"/> Tetraclip	(Quick release axle for quadriplegic)		03947	177,00
<input type="checkbox"/> Safety pelvic belt			03972	63,00
<input type="checkbox"/> Harness			04103	126,00
<input type="checkbox"/> Lumbar support	(to insert in the backrest upholstery)		00013	40,00
<input type="checkbox"/> Swing away lateral support	<input type="checkbox"/> Right		02097	252,00
Not available with:	<input type="checkbox"/> Left		02098	252,00
Posture backrest PHYSIO - Posture backrest A I R				
<input type="checkbox"/> Spoke guards Black	(22"-24")		01043	148,00
<input type="checkbox"/> Spoke guards Transparent	(22"-24")		00835	148,00
<input type="checkbox"/> Spoke guards Progeo design	(22"-24")		00019	177,00
<input type="checkbox"/> Spoke guards Dragon	(22"-24")		02106	177,00





Additional Kit				
<input type="checkbox"/> 24" Off-road rear wheels	Off-Road tyre - aluminium handrim (black colour)		03378	498,00
<input type="checkbox"/> 24" FAT rear wheels	FAT tyre 3" - aluminium handrim (black colour)		09357	876,00

Date Order User Address

PHYSIO - Posture backrest (Std. Backrest upholstery not provided)

Removable with quick release
Suitable for tubes with diameter 18+26mm
Depth adjustment (4cm)
Angle adjustment (±18°)

- AIR** Carbon shell
not available for seat width 48

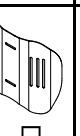
BACKREST HEIGHT	28	34	40	
Shell's shape 	Lateral retaining wing A=high - R=regular			
				
	<input type="checkbox"/>	<input type="checkbox"/>	<input type="checkbox"/>	<input type="checkbox"/>

1.047,00

- POSTURE** Aluminum shell

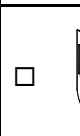
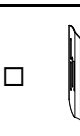
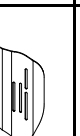
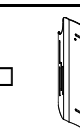
BACKREST HEIGHT	34	40	52	
Shell's shape 	Lateral retaining wing B=regular			
				
	<input type="checkbox"/>	<input type="checkbox"/>	<input type="checkbox"/>	<input type="checkbox"/>

1.013,00

Configuration DEEP with side support PAD (height adjustable)

- Aluminum lateral with padded, breathable upholstery.



Small (h 13cm)



Right
10272

29,00

Left
10272

Large (h 20cm)



Right
10273

40,00

Left
10273

40,00

SWING AWAY - Lateral support

Fixing and adjustment hardware complete with protection sleeve
Aluminum lateral with padded, breathable upholstery.

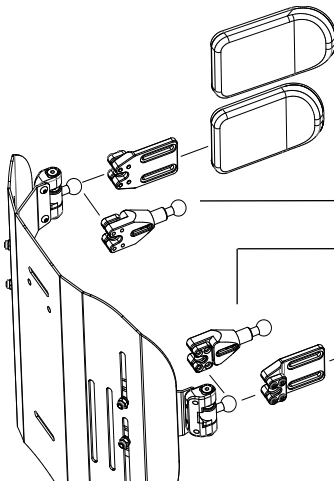

- Large (18x12)

05647 183,00

- Small (14x9)

05643 183,00

- Lateral support extension

Quantity (number pcs).....

10271 69,00

- Lateral support extension

Quantity (number pcs).....

- Small (14x9)

05642 183,00

- Large (18x12)

05646 183,00

- Headrest adjustable - Double ball mounting system



Available only with backrest Physio
Not available for backrest Physio AIR carbon shell

- Large (34x14)
- Small (28x14)

05648 252,00

Date	Order	User	Address
------------	-------------	------------	---------------

Note

Wheelchair : Progeo DUKE - Rev. 2023.2	Prices - VAT excluded <small>to be added to the price list</small>	Send this page only if any optional have been chosen <input type="checkbox"/> standard <small>(supplied if no requests are indicated)</small> <input type="checkbox"/> on request <small>(without extra charge)</small> <input type="checkbox"/> optional <small>(cost to be added at the basic price)</small>
---	--	---