

Permobil Limited Unit 7, Polaris Centre, 41 Brownfields, Welwyn Garden City, Herts, AL7 1AN United Kingdom - Phone: +44 1484 722888

UK (English)

Date

User

End user weight (kg)

Language user manual

Company stamp

Responsible

Folding frame wheelchair

£ 4716,00

Retail price - VAT not included

Wheelchair measures	
Keep attention to all measures.	
EGO CUSTOM is a welded frame wheelchair, thus seat height and setting can not be modified after its manufacturing.	
Seat width (LS)	<input type="checkbox"/> 33 <input type="checkbox"/> 36 <input type="checkbox"/> 39 <input type="checkbox"/> 42 <input type="checkbox"/> 45 <input type="checkbox"/> 48 <small>The seat width is measured from the outer sides of the frame, while the distance between the two side guards is 1 cm wider.</small>
Seat depth (PS)	<input type="checkbox"/> 35 <input type="checkbox"/> 37,5 <input type="checkbox"/> 40 <input type="checkbox"/> 42,5 <input type="checkbox"/> 45 <input type="checkbox"/> 47,5 <small>The real seat depth, from the front part of the seat cloth to the backrest tube will be 1,5 cm more than the declared one.</small>
Footplate distance (DP) (cm) ±0.5cm - adjustment steps 1.5cm <small>(Real distance between seat and footplate) - IMPORTANT NOTICE! From the footplate to the floor minimum 4cm !! (Minimum Front height = DP + 4cm)</small>
Setting	<input checked="" type="checkbox"/> Standard <input type="checkbox"/> Prudential <input type="checkbox"/> Active
Backrest Height (TS)	Std.Value 33,5 (min 26-max 47) adjustment steps 1.5cm
camber	<input checked="" type="checkbox"/> 0° <input type="checkbox"/> 2°
Front height (min 44-max 52)
Rear height (min 38-max 45) calculated with rear wheels 24"

Front frame

Aluminium frame - welded made-to-measure
Footplate COMPACT, automatic Closure adjustable distance +/- 1,5cm

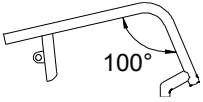
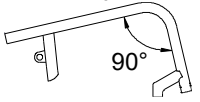
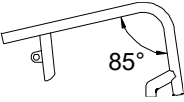
 <input type="checkbox"/> (max 5" caster)	 <input type="checkbox"/> (max 5" caster)	 <input type="checkbox"/> (max 4" caster)
--	--	---

Frame colour

<input checked="" type="checkbox"/> Bright silver	<input type="checkbox"/> Opaque black	<input type="checkbox"/> Pearl white	<input type="checkbox"/> Matt orange
<input type="checkbox"/> Tekno anthracite	<input type="checkbox"/> Matt Midnight blue	<input type="checkbox"/> Matt grey	<input type="checkbox"/> Matt red

Backrest

Adjustable velcro straps and padded transpiring upholstery

Handle tube

Tubes with short handle

SPORT tubes Without push handles *Lightest configuration*

Folding handles
Not available with: Push handles for companion

02958 **260,00**

Casters

4" Soft

3" Sport *Lightest configuration*

5" Soft

<input type="checkbox"/> 3" Active Soft (wide)	(Aluminium alloy rim)	06824	130,00
<input type="checkbox"/> 4" Active Sport (narrow)	(Aluminium alloy rim)	01398	130,00
<input type="checkbox"/> 4" Active Soft (wide)	(Aluminium alloy rim)	03943	130,00
<input type="checkbox"/> 5" Active Soft (wide)	(Aluminium alloy rim)	07518	130,00
<input type="checkbox"/> 5" Pneumatic		10844	65,00

customer_support_uk@permobil.com - https://www.permobil.com/en-gb

Date	Order	User	Address
------------	-------------	------------	---------------

Special Options		
<input type="radio"/> lockingband/strip to close/fold the wheelchair	06833	24,00
<input type="radio"/> Drawstring to unlock the back with a singleaction	06834	130,00

Colour set: includes rear wheel hub and rim and front forks		
Only standard Progeo 22"/24" wheels have coloured hubs and rims		
☆ Black	22" 24" 25" 26"	
<input type="radio"/> Bright silver	22" 24"	00833 130,00
<input type="radio"/> Bright lime	22" 24"	00833 130,00
<input type="radio"/> Bright blue	22" 24"	00833 130,00
<input type="radio"/> Bright red	22" 24"	00833 130,00
<input type="radio"/> Bright fuchsia	22" 24"	00833 130,00
<input type="radio"/> Pearl white	22" 24"	00833 130,00
<input type="radio"/> Tekno anthracite	22" 24"	00833 130,00
<input type="radio"/> Matt Midnight blue	22" 24"	00833 130,00
<input type="radio"/> Matt grey	22" 24"	00833 130,00
<input type="radio"/> Matt red	22" 24"	00833 130,00

Rear wheels		
☆ 24" Ultra-light Progeo - Standard!		
<input type="checkbox"/> 22" Ultra-light Progeo - Standard!		
<input type="checkbox"/> 25" Ultra-light Progeo - Standard!	(colour: black)	
<input type="checkbox"/> 26" Progeo - Standard!	(colour: black)	
<input type="radio"/> 24" ULTRA-LIGHT PROGEO KEY SPORT	<i>Lightest configuration</i>	04383 902,00
<input type="radio"/> 24" Ultra-light "Spinergy LX"		01685 902,00
<input type="radio"/> 24" Ultra-light "Spinergy LXL"	<input type="checkbox"/> Black hub and white spokes <input type="checkbox"/> Hub and spokes black	07846 902,00
<input type="radio"/> 24" Ultra-light "Spinergy Flex rim"	Integrated aluminium/rubber handrim	02270 1.415,00
<input type="radio"/> 25" Ultra-light "Spinergy LX"		02101 902,00
<input type="radio"/> 25" Ultra-light "Spinergy LXL"	<input type="checkbox"/> Black hub and white spokes	07847 902,00
<input type="radio"/> 26" Ultra-light "Spinergy LX"		02102 902,00
<input type="radio"/> 24" Off-road (aluminium handrim black)		01392 231,00

Rear wheel tyre		
☆ High pressure tyre	(22"-24"-25"-26")	<i>Lightest configuration</i>
<input type="checkbox"/> High pressure profile tyre	(24")	
<input type="radio"/> Marathon Plus	(24"-25")	with anti-puncture protection
<input type="radio"/> Anti-puncture - Colour Black	(24")	11083 130,00
Not available with Rear wheels : 24" ULTRA-LIGHT PROGEO KEY SPORT, 24" Ultra-light "Spinergy LXL"		
<input type="radio"/> Anti-puncture - Colour Grey	(22")	04181 101,00

Handrim	Wheel distance ☆ 3 cm	□ 4 cm		
☆ Aluminium	(22"-24"-25"-26")	<i>Lightest configuration</i>		
<input type="radio"/> Aluminium black SOFT-TOUCH	(24"-25")	(24" handrim, on 25" wheel is installed with spacers)	09170	130,00
<input type="radio"/> Chromed Steel	(24"-25")	(24" handrim, on 25" wheel is installed with spacers)	01684	152,00
<input type="radio"/> Titanium	(24"-25")	(24" handrim, on 25" wheel is installed with spacers)	00016	283,00
<input type="radio"/> Ultra Grepp	(24"-25")	(24" handrim, on 25" wheel is installed with spacers)	00017	324,00
<input type="radio"/> Max Grepp	(24"-25")	(24" handrim, on 25" wheel is installed with spacers)	00834	359,00
<input type="radio"/> TOP FRICTION	(24"-25")	(24" handrim, on 25" wheel is installed with spacers)	11023	411,00
Oval countour with a rubber insert				
<input type="radio"/> NOVA H	(24"-25")	(24" handrim, on 25" wheel is installed with spacers)	11025	271,00
Ergonomic black profile				
<input type="radio"/> NOVA D	(24"-25")	(24" handrim, on 25" wheel is installed with spacers)	11026	295,00
Ergonomic profile with rubber coating (ideal for quadriplegics)				
<input type="radio"/> SURGE LT	(25")	Oval countour with a rubber insert	06427	371,00
<input type="radio"/> Quad	(24")		00693	206,00
<input type="radio"/> Silicon cover for standard aluminium handrim		Available for measures (22"- 24" - 26")	04050	165,00

Date Order User Address

Wheel locks

- Bent lever push to lock
- Straight lever push to lock
- Straight lever pull to lock
- Sport brake
- Brake with extension lever push to lock
- Brake with extension lever pull to lock



06428 130,00
01949 65,00
03372 65,00

Automatic Closure footplate

- Footplate COMPACT, automatic Closure

Lightest configuration



11529

Minimum footplate distance 35cm.

RAKE AND DEPTH ADJUSTABLE

- Internal
- External

Mudguard

Mudguard - FIXED

- Carbon fibre mudguard
- Carbon fibre Straight sideguard



Extra charge for : REMOVABLE VERSION

08921 130,00

Armrests

- Tubular armrests (Swing away, removable and height adjustable armrest)
Exclude the installation OPTIONAL 1



00694 260,00

Removable armrest with ABS mudguard

- Desk armrests PROGEO (Removable and height adjustable)

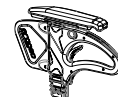

09956 231,00

- Removable armrest with carbon-fiber straight sideguard



09079 231,00

Accessories





- Pad for front frame protectors 07058 54,00
- Backrest-seat connection cloth 10241 18,00
- Removable storage bag (with quick coupling) 09811 130,00

Date Order User Address

Optional 1

Important notice! With the EGO CUSTOM you may choose only one of these accessories with fee

Attention none of these accessories are available if have been chosen the Tubular armrests

<input type="radio"/> Transit wheels			00836	152,00
<input type="radio"/> Anti-tipper with rapid hookup	(inside rotation to reduce the encumbrance)		00023	130,00
<input type="radio"/> Right	<input type="radio"/> Left		00024	130,00
<input type="radio"/> Tipping aid	<input type="radio"/> Right		00025	76,00
	<input type="radio"/> Left		01046	76,00
<input type="radio"/> Crutches support	<input type="radio"/> Right		00838	76,00
	<input type="radio"/> Left		00837	76,00

Optional 2

<input type="radio"/> Tetracrip	(Quick release axle for quadriplegic)		03947	182,00
<input type="radio"/> Safety pelvic belt			03972	65,00
<input type="radio"/> Harness			04103	130,00
<input type="radio"/> Push handles for companion	(Removable and height adjustable)		01048	195,00
<input type="radio"/> Lumbar support	(to insert in the backrest upholstery)		00013	41,00
<input type="radio"/> Swing away lateral support	<input type="radio"/> Right		02097	260,00
Not available with Posture backrest PHYSIO	<input type="radio"/> Left		02098	260,00
<input type="radio"/> Spoke guards Black	(22"-24")		01043	152,00
<input type="radio"/> Spoke guards Transparent	(22"-24")		00835	152,00
<input type="radio"/> Spoke guards Progeo design	(22"-24")		00019	182,00
<input type="radio"/> Spoke guards Dragon	(22"-24")		02106	182,00

Additional Kit

<input type="radio"/> 24" Off-road rear wheels	Off-Road tyre - aluminium handrim (black colour)	03378	513,00
<input type="radio"/> 24" FAT rear wheels	FAT tyre 3" - aluminium handrim (black colour)	09357	902,00

Date Order User Address

PHYSIO - Posture backrest (Std. Backrest upholstery not provided)

Removable with quick release
Suitable for tubes with diameter 18+26mm
Depth adjustment (4cm)
Angle adjustment (±18°)

- AIR** Carbon shell
not available for seat width 48

BACKREST HEIGHT	28	34	40			
Shell's shape 	Lateral retaining wing A=high - R=regular					
	A	R	A	R	A	R
7.5 cm						
	<input type="checkbox"/>	<input type="checkbox"/>	<input type="checkbox"/>	<input type="checkbox"/>	<input type="checkbox"/>	<input type="checkbox"/>

1.078,00

- POSTURE** Aluminum shell

BACKREST HEIGHT	34	40	52			
Shell's shape 	Lateral retaining wing R=regular					
	R	R	R	R	R	R
7.5 cm						
	<input type="checkbox"/>	<input type="checkbox"/>	<input type="checkbox"/>	<input type="checkbox"/>	<input type="checkbox"/>	<input type="checkbox"/>

1.043,00

Configuration DEEP with side support PAD (height adjustable)

- Aluminum lateral with padded, breathable upholstery.



Small (h 13cm)



Right
10272

30,00



Left
10272

30,00

Large (h 20cm)



Right
10273

41,00



Left
10273

41,00

SWING AWAY - Lateral support

Fixing and adjustment hardware complete with protection sleeve
Aluminum lateral with padded, breathable upholstery.

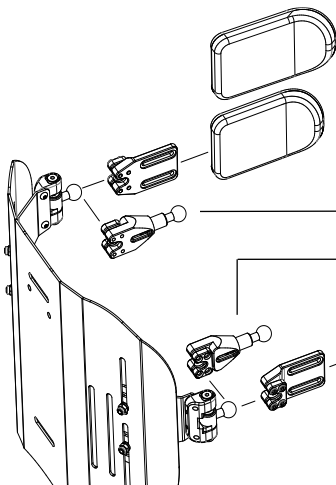

- Large (18x12)

05647 188,00

- Small (14x9)

05643 188,00

- Lateral support extension

Quantity (number pcs).....

- Lateral support extension

Quantity (number pcs)..... 10271 71,00

- Small (14x9)

05642 188,00

- Large (18x12)

05646 188,00

- Headrest adjustable - Double ball mounting system

Available only with backrest Physio Posture



- Large (34x14)
- Small (28x14)

05648 295,00

Permobil Limited Unit 7, Polaris Centre, 41 Brownfields, Welwyn Garden City, Herts, AL7 1AN United Kingdom - Phone: +44 1484 722888



customer_support_uk@permobil.com - https://www.permobil.com/en-gb

Date	Order	User	Address
------------	-------------	------------	---------------

Note

Wheelchair : Progeo EGO CUSTOM - Rev. 2024.1	Prices - VAT excluded <small>to be added to the price list</small>	<table border="1" style="width: 100%; border-collapse: collapse;"> <tr> <th colspan="2" style="text-align: left; padding: 2px;">Send this page only if any optional have been chosen</th> </tr> <tr> <td style="width: 10px; text-align: center; padding: 2px;">☆</td> <td style="padding: 2px;">standard <small>(supplied if no requests are indicated)</small></td> </tr> <tr> <td style="width: 10px; text-align: center; padding: 2px;"><input type="checkbox"/></td> <td style="padding: 2px;">on request <small>(without extra charge)</small></td> </tr> <tr> <td style="width: 10px; text-align: center; padding: 2px;"><input type="radio"/></td> <td style="padding: 2px;">optional <small>(cost to be added at the basic price)</small></td> </tr> </table>	Send this page only if any optional have been chosen		☆	standard <small>(supplied if no requests are indicated)</small>	<input type="checkbox"/>	on request <small>(without extra charge)</small>	<input type="radio"/>	optional <small>(cost to be added at the basic price)</small>
Send this page only if any optional have been chosen										
☆	standard <small>(supplied if no requests are indicated)</small>									
<input type="checkbox"/>	on request <small>(without extra charge)</small>									
<input type="radio"/>	optional <small>(cost to be added at the basic price)</small>									

REFERENCE TABLES

1		Front height		
With closed frame (95°) max 5" caster With closed frame (90°) max 5" caster With closed frame (85°) max 4" caster				
FORK	3"	Casters		5"
		4"	4"	
SPORT 	max 44	max 45		
SMALL 	max 46	max 47		max 48
MEDIUM 	max 50	max 51		max 52
The size of the fork will be defined only by Progeo in accordance with wheelchair final configuration.				

2		Rear height			
Rear wheels					
	22"	24"	25"	26"	
min	35	min 38	min 39	min 40	
max	43	max 45	max 46	max 48	

3	Footplate option	Footplate distance
	Footplate COMPACT, automatic Closure	min 36
IMPORTANT NOTICE! From the footplate to the floor minimum 4cm !! (Minimum Front height = DP + 4cm) NOTE! Lower footplate distances are possible only after our valuation Calculated with the best configuration and with the footplates positioned on inside.		

4	Rear wheels	
	Model	Features
	22" Ultra-light Progeo - Standard!	(not available in anthracite color)
	24" Ultra-light Progeo - Standard!	(available for all colors)
	24" ULTRA-LIGHT PROGEO KEY SPORT	(silver hub, black rim and 16 spokes)
	24" Ultra-light "Spinergy LX"	(silver hub, black rim and spokes)
	24" Ultra-light "Spinergy LXL"	(black hub and rim, 18 white spokes) - (black hub, rim and 18 spokes)
	24" Off-road	(colour: black) - (aluminium handrim - tyre Off-road)
	24" Ultra-light "Spinergy Flex rim"	(silver hub, black rim and spokes) - (integrated aluminium/rubber handrim - encumbrance reduction up to 3cm. - all tyre)
	25" Ultra-light "Spinergy LX"	(silver hub, black rim and spokes)
	25" Ultra-light "Spinergy LXL"	(black hub and rim, 18 white spokes)
	26" Progeo - Standard!	(colour: black)
	26" Ultra-light "Spinergy LX"	(silver hub, black rim and 18 spokes)