

Permobil Limited Unit 7, Polaris Centre, 41 Brownfields, Welwyn Garden City, Herts, AL7 1AN United Kingdom - Phone: +44 1484 722888

Date
 User
 End user weight (kg)
 Language user manual
 UK (English)
 Company stamp
 Responsible

CRASH TEST APPROVED
 Folding frame wheelchair



£ 2476,00
Retail price - VAT not included

| Wheelchair measures - The tolerance on all the dimensions indicated and/or required is ± 10 mm | |
|--|--|
| Seat width (LS) | <input type="checkbox"/> 33 <input type="checkbox"/> 36 <input type="checkbox"/> 39 <input type="checkbox"/> 42 <input type="checkbox"/> 45 <input type="checkbox"/> 48 |
| Seat depth (PS) | <input type="checkbox"/> 35 <input type="checkbox"/> 37,5 <input type="checkbox"/> 40 <input type="checkbox"/> 42,5 <input type="checkbox"/> 45 <input type="checkbox"/> 47,5 |
| Footplate distance (DP) | (cm) ±0.5cm - adjustment steps 1.5cm <u>(Real distance between seat and footplate) - IMPORTANT NOTICE! From the footplate to the floor minimum 4cm !! (Minimum Front height = DP + 4cm)</u> |
| Setting | ☆ Standard <input type="checkbox"/> Prudential <input type="checkbox"/> Active <input type="checkbox"/> Extreme |
| Backrest Height (TS) | Std. Value 36(min 30-max 54) adjustment steps 1.5cm |
| Crossbrace (black) | ☆ Single <input type="checkbox"/> Double (Not seat width 33-36) |
| Front height | (STD 49) - Rear height (STD 44) |

SAFETY
 4 points tie-down system rings
NOT AVAILABLE WITH: Aluminium frame DYNAMIC 2.0 - Titanium frame T MAX
 The use of a headrest during transport is mandatory
 (installation must be carried out by the manufacturer)

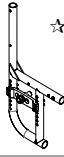

08654 **195,00**

| Rear frame | |
|---------------------|--|
| Aluminium frame | <input checked="" type="radio"/> Aluminium standard frame - Same colour of front frame  The real seat depth, from the front part of the seat cloth to the backrest tube will be 1 cm more than the declared one. camber ☆ 0° <input type="checkbox"/> 1,5° <input type="checkbox"/> 3° |
| | <input type="radio"/> Aluminium frame DYNAMIC 2.0 - (COLOUR: BLACK) 09955 324,00  The real seat depth, from the front part of the seat cloth to the backrest tube will be 1,5 cm more than the declared one. With rake adjustable backrest (±9°) Exclude the installation of : Brake handles for companion (Drum Brake) - 4 points tie-down system rings camber ☆ 0° <input type="checkbox"/> 1,5° <input type="checkbox"/> 2° <input type="checkbox"/> 4° |
| Titanium frame TMAX | <input type="radio"/> Titanium frame T MAX 03940 383,00  The real seat depth, from the front part of the seat cloth to the backrest tube will be 1 cm more than the declared one. <u>Brushed Titanium frame - not varnished</u> <u>Weight reduction approx. 250gr</u> <u>Exclude the installation of : 4 points tie-down system rings</u> camber ☆ 0° <input type="checkbox"/> 1,5° <input type="checkbox"/> 3° |

Front frame

Short frame - Ideal with Seat depth (PS) 35 - 37,5

Medium frame - Ideal with Seat depth (PS) 40 - 42,5

Long frame - Ideal with Seat depth (PS) 45 - 47,5

Frame Angle

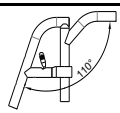
 ☆ 110°

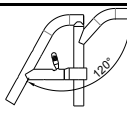
 120°

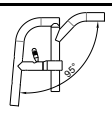
 95°

Elevating front frame, swing away and removable 09730 **260,00**
Include calf supports and plastic footrest with heel band
 (not available for seat width 33)
Minimum footplate distance 25cm.



Frame colour

Frame colour (without extra charge)

| | | |
|--------------------------------------|---|------------------------------------|
| ☆ Opaque black | <input type="checkbox"/> Tekno anthracite | <input type="checkbox"/> Matt grey |
| <input type="checkbox"/> Pearl white | <input type="checkbox"/> Matt Midnight blue | <input type="checkbox"/> Matt red |

Frame colour on request

| | | | |
|-------------------------------------|--------------------------------------|---|---------------------|
| <input type="radio"/> Bright silver | <input type="radio"/> Bright fuchsia | <input type="radio"/> Bright blue china | 12579 105,00 |
| <input type="radio"/> Bright blue | <input type="radio"/> Bright lime | <input type="radio"/> Bright red | |

Backrest
 ☆ Adjustable velcro straps and padded transpiring upholstery

customer_support_uk@permobil.com - https://www.permobil.com/en-gb

| | | | |
|------------|-------------|------------|---------------|
| Date | Order | User | Address |
|------------|-------------|------------|---------------|

| | | |
|---|--|---|
| Handle tube | |  |
| ☆ Tubes with standard handle | | |
| <input type="radio"/> Folding handles | | 02958 260,00 |
| <i>Not available with: Push handles for companion, Brake handles for companion (Drum Brake)</i> | | |

| | | | |
|---|-----------------|-------|---------------|
| Colour set: Includes rear wheel hub and rim, rear wheel plates and front forks | | | |
| Only standard Progeo 22"/24" wheels have coloured hubs and rims | | | |
| ☆ Black | 22" 24" 25" 26" | | |
| <input type="radio"/> Bright silver | 22" 24" | 00833 | 130,00 |
| <input type="radio"/> Bright lime | 22" 24" | 00833 | 130,00 |
| <input type="radio"/> Bright blue | 22" 24" | 00833 | 130,00 |
| <input type="radio"/> Bright red | 22" 24" | 00833 | 130,00 |
| <input type="radio"/> Bright fuchsia | 22" 24" | 00833 | 130,00 |
| <input type="radio"/> Pearl white | 22" 24" | 00833 | 130,00 |
| <input type="radio"/> Tekno anthracite | 22" 24" | 00833 | 130,00 |
| <input type="radio"/> Matt Midnight blue | 22" 24" | 00833 | 130,00 |
| <input type="radio"/> Matt grey | 22" 24" | 00833 | 130,00 |
| <input type="radio"/> Matt red | 22" 24" | 00833 | 130,00 |





| | | | |
|--|------------------------------------|-------|---------------|
| Casters | | | |
| ☆ 5" Soft | | | |
| <input type="checkbox"/> 4" Soft | | | |
| <input type="checkbox"/> 3" Sport | <i>Lightest configuration</i> | | |
| <input type="checkbox"/> 6" Soft | Not available with frame angle 95° | | |
| <input type="checkbox"/> 6" Pneumatic | Not available with frame angle 95° | | |
| <input type="checkbox"/> 7" Soft | Not available with frame angle 95° | | |
| <input type="radio"/> 3" Active Soft (wide) | (Aluminium alloy rim) | 06824 | 130,00 |
| <input type="radio"/> 4" Active Sport (narrow) | (Aluminium alloy rim) | 01398 | 130,00 |
| <input type="radio"/> 4" Active Soft (wide) | (Aluminium alloy rim) | 03943 | 130,00 |
| <input type="radio"/> 5" Active Soft (wide) | (Aluminium alloy rim) | 07518 | 130,00 |
| <input type="radio"/> 5" Pneumatic | | 10844 | 65,00 |



| | | | |
|--|--|-------|-----------------|
| Rear wheels | | | |
| ☆ 24" Ultra-light Progeo - Standard! | | | |
| <input type="checkbox"/> 22" Ultra-light Progeo - Standard! | | | |
| <input type="checkbox"/> 25" Ultra-light Progeo - Standard! (colour: black) | | | |
| <input type="checkbox"/> 26" Progeo - Standard! (colour: black) | | | |
| <input type="radio"/> 24" ULTRA-LIGHT PROGEO KEY SPORT | <i>Lightest configuration</i> | 04383 | 902,00 |
| <input type="radio"/> 24" Ultra-light "Spinergy LX" | | 01685 | 902,00 |
| <input type="radio"/> 24" Ultra-light "Spinergy LXL" | <input type="checkbox"/> Black hub and white spokes | 07846 | 902,00 |
| <input type="radio"/> 24" Ultra-light "Spinergy Flex rim" | Integrated aluminium/rubber handrim | 02270 | 1.415,00 |
| <input type="checkbox"/> Hub and spokes black | | | |
| <input type="radio"/> 25" Ultra-light "Spinergy LX" | | 02101 | 902,00 |
| <input type="radio"/> 25" Ultra-light "Spinergy LXL" | <input type="checkbox"/> Black hub and white spokes | 07847 | 902,00 |
| <input type="radio"/> 26" Ultra-light "Spinergy LX" | | 02102 | 902,00 |
| <input type="radio"/> 24" Off-road (aluminium handrim black) | | 01392 | 231,00 |
| <input type="radio"/> 22" with brake handles for companion (drum brake) (aluminium handrim - Wheel distance 3cm) | | 03385 | 371,00 |
| Available only with camber 0° | | | |
| Not available with Frame Dynamic 2.0 | | | |
| <input type="radio"/> 24" with brake handles for companion (drum brake) (aluminium handrim - Wheel distance 3cm) | | 03384 | 371,00 |
| Available only with camber 0° | | | |
| Not available with Frame Dynamic 2.0 | | | |
| <input type="radio"/> One arm drive - (24" rear wheels Aluminium handrim High pressure Tyre) - camber 0° | | | |
| | <input type="radio"/> Right <input type="radio"/> Left | 02103 | 413,00 |

| | | | |
|--|-------------------|-------------------------------|---------------------|
| Rear wheel tyre | | | |
| ☆ High pressure tyre | (22"-24"-25"-26") | <i>Lightest configuration</i> | |
| <input type="checkbox"/> High pressure profile tyre | (24") | | |
| <input type="radio"/> Marathon Plus | (24"-25") | with anti-puncture protection | 01669 65,00 |
| <input type="radio"/> Anti-puncture - Colour Black | (24") | | 11083 130,00 |
| Not available with Rear wheels : 24" ULTRA-LIGHT PROGEO KEY SPORT, 24" Ultra-light "Spinergy LXL" | | | |
| <input type="radio"/> Anti-puncture - Colour Grey | (22") | | 04181 101,00 |

Date Order User Address

| Handrim | Wheel distance ☆ 3 cm | □ 4 cm | | |
|---|-----------------------|--------|---|---------------------|
| ☆ Aluminium | (22"-24"-25"-26") | | <i>Lightest configuration</i> | |
| ○ Aluminium black SOFT-TOUCH | (24"-25") | | (24" handrim, on 25" wheel is installed with spacers) | 09170 130,00 |
| ○ Chromed Steel | (24"-25") | | (24" handrim, on 25" wheel is installed with spacers) | 01684 152,00 |
| ○ Titanium | (24"-25") | | (24" handrim, on 25" wheel is installed with spacers) | 00016 283,00 |
| ○ Ultra Grepp | (24"-25") | | (24" handrim, on 25" wheel is installed with spacers) | 00017 324,00 |
| ○ Max Grepp | (24"-25") | | (24" handrim, on 25" wheel is installed with spacers) | 00834 359,00 |
| ○ TOP FRICTION | (24"-25") | | (24" handrim, on 25" wheel is installed with spacers) | 11023 411,00 |
| Oval countour with a rubber insert | | | | |
| ○ NOVA H | (24"-25") | | (24" handrim, on 25" wheel is installed with spacers) | 11025 271,00 |
| Ergonomic black profile | | | | |
| ○ NOVA D | (24"-25") | | (24" handrim, on 25" wheel is installed with spacers) | 11026 295,00 |
| Ergonomic profile with rubber coating (ideal for quadriplegics) | | | | |
| ○ SURGE LT | (25") | | Oval countour with a rubber insert | 06427 371,00 |
| ○ Quad | (24") | | | 00693 206,00 |
| ○ Silicon cover for standard aluminium handrim | | | Available for measures (22"- 24" - 26") | 04050 165,00 |

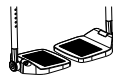
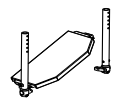
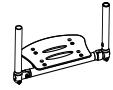
| Wheel locks | | | |
|---|--|--|---------------------|
| ☆ Bent lever push to lock | |  | |
| □ Straight lever push to lock | |  | |
| □ Straight lever pull to lock | | | |
| ○ Sport brake | |  | 06428 130,00 |
| ○ Brake with extension lever push to lock | |  | 01949 65,00 |
| ○ Brake with extension lever pull to lock | | | 03372 65,00 |





| Footplate (Not available with Elevating front frame, swing away and removable) - See reference tables N°3 | | | |
|---|---|---|---------------------|
| ☆ Plastic footrest, rake adjustable | |  | 11525 |
| Not available with Elevating front frame, swing away and removable | | | |
| Minimum footplate distance 27cm. | ☆ 2/3 Internal □ 2/3 External | | |
| □ One piece footplate - Flip-up! rake and depth adjustable | |  | 11527 |
| Not available with Elevating front frame, swing away and removable | | | |
| Minimum footplate distance 26cm. | □ Internal ☆ 2/3 Internal □ External | | |
| ○ Minimum footplate distance 21cm. Available only with Multi-function and rotative system - 03945 | | | 195,00 |
| □ One piece aluminium footplate - Flip-up! rake and depth adjustable | |  | 11528 |
| Not available with Elevating front frame, swing away and removable | | | |
| Minimum footplate distance 26cm. | □ Internal ☆ 2/3 Internal □ 2/3 External □ External | | |
| ○ One piece Carbon fibre footplate rake adjustable, swing away, flip-up. | |  | 03291 283,00 |
| Not available with Elevating front frame, swing away and removable | | | |
| Minimum footplate distance 26cm. | ☆ Internal □ External | | |

| Mudguard | | | |
|---|--|---|---------------------|
| Mudguard - FIXED | | | |
| ☆ ABS mudguard | |  | |
| □ ABS Straight sideguard | | | |
| ○ Carbon fibre mudguard | | | 03946 324,00 |
| ○ Carbon fibre Straight sideguard | | | 08918 324,00 |
| Mudguard - REMOVABLE | | | |
| ○ Removable ABS mudguard | | | 08921 130,00 |
| ○ Removable ABS fibre straight sideguard | |  | 08921 130,00 |
| ○ Removable carbon fibre mudguard | | | 08919 448,00 |
| ○ Removable Carbon fibre straight sideguard | | | 08920 448,00 |

Date Order User Address

Armrests





Tubular armrests with standard support combined with anti-tipper wheels exclude the possibility of installing the transit wheels.

- | | | | |
|--|--|---|--|
| <input type="radio"/> Tubular armrests | (Swing away, removable and height adjustable armrest) <input type="radio"/> Standard Support (Not with frame Dynamic) <input type="radio"/> Steel support with safety locking system |  | 04828 182,00 00694 260,00 |
| Removable armrest with ABS mudguard | | | |
| <input type="radio"/> Desk armrests PROGEO | (Removable and height adjustable) Not available with Frame Dynamic 2.0 + camber 4° |  | 09956 231,00 |
| <input type="radio"/> Flip-up armrests PROGEO | (Removable and height adjustable) Not available with Frame Dynamic 2.0 |  | 12277 224,00 |
| <input type="radio"/> Removable armrest with ABS straight sideguard | |  | 08881 231,00 |
| <input type="radio"/> Removable armrest with carbon-fiber straight sideguard | |  | 08882 467,00 |



Accessories

- | | | |
|---|--|---------------------|
| <input type="radio"/> Pad for front frame protectors | | 07058 54,00 |
| <input type="radio"/> Backrest-seat connection cloth | | 10241 18,00 |
| <input type="radio"/> Removable storage bag (with quick coupling) | | 09811 130,00 |

Optional 1

- | | | | |
|---|--|---|--|
| <input type="radio"/> Transit wheels | |  | 00836 152,00 |
| <input type="radio"/> Anti-tipper with rapid hookup | (inside rotation to reduce the encumbrance) <input type="radio"/> Right <input type="radio"/> Left |  | 00023 130,00 00024 130,00 |
| <input type="radio"/> Tipping aid | <input type="radio"/> Right <input type="radio"/> Left |  | 00025 76,00 01046 76,00 |
| <input type="radio"/> Crutches support | <input type="radio"/> Right <input type="radio"/> Left |  | 00838 76,00 00837 76,00 |

Optional 2

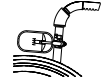
- | | | | |
|---|---|---|--|
| <input type="radio"/> Tetraclick | (Quick release axle for quadriplegic) | | 03947 182,00 |
| <input type="radio"/> Rear wheels plate extension | (Not with frame Dynamic 2.0) | | 01950 182,00 |
| <input type="radio"/> Handybike adaptor | | | 00506 76,00 |
| <input type="radio"/> Push handles for companion | (Removable and height adjustable) |  | 01048 195,00 |
| <input type="radio"/> Harness | | | 04103 130,00 |
| <input type="radio"/> Safety pelvic belt | | | 03972 65,00 |
| <input type="radio"/> Tray table (removable) | | | 00508 283,00 |
| <input type="radio"/> Lumbar support | (to insert in the backrest upholstery) | | 00013 41,00 |
| <input type="radio"/> Super Head rest | (Folding with the wheelchair) |  | 04049 467,00 |
| <input type="radio"/> Swing away lateral support | <input type="radio"/> Right <input type="radio"/> Left |  | 02097 260,00 02098 260,00 |
| Not available with Posture backrest PHYSIO | | | |
| <input type="radio"/> Spoke guards Black | (22"-24") | | 01043 152,00 |
| <input type="radio"/> Spoke guards Transparent | (22"-24") | | 00835 152,00 |
| <input type="radio"/> Spoke guards Progeo design | (22"-24") | | 00019 182,00 |
| <input type="radio"/> Spoke guards Dragon | (22"-24") | | 02106 182,00 |

Additional Kit







- | | | |
|--|--|---------------------|
| <input type="radio"/> 24" Off-road rear wheels | Off-Road tyre - aluminium handrim (black colour) | 03378 513,00 |
| <input type="radio"/> 24" FAT rear wheels | FAT tyre 3" - aluminium handrim (black colour) | 09357 902,00 |

Date Order User Address

PHYSIO - Posture backrest (Std. Backrest upholstery not provided)



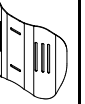

Removable with quick release
Suitable for tubes with diameter 18+26mm
Depth adjustment (4cm)
Angle adjustment (±18°)

- AIR** Carbon shell
not available for seat width 48

| BACKREST HEIGHT | 28 | 34 | 40 | | | |
|--|---|--|---|---|---|---|
| Shell's shape  | Lateral retaining wing A=high - R=regular | | | | | |
| | A | R | A | R | A | R |
| |  |  |  |  |  |  |
| | <input type="checkbox"/> | <input type="checkbox"/> | <input type="checkbox"/> | <input type="checkbox"/> | <input type="checkbox"/> | <input type="checkbox"/> |

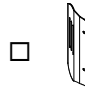
1.078,00

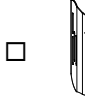
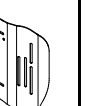
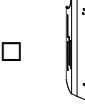
- POSTURE** Aluminum shell

| BACKREST HEIGHT | 34 | 40 | 52 | | | |
|---|--|---|--|--|--|--|
| Shell's shape  | Lateral retaining wing R=regular | | | | | |
| | R | | R | | R | |
| |  |  |  |  |  |  |
| | <input type="checkbox"/> | <input type="checkbox"/> | <input type="checkbox"/> | <input type="checkbox"/> | <input type="checkbox"/> | <input type="checkbox"/> |

1.043,00

Configuration DEEP with side support PAD (height adjustable)

- Alluminum lateral with padded, breathable upholstery.



Small (h 13cm)



- Right 10272

30,00

- Left 10272

30,00

Large (h 20cm)



- Right 10273

41,00

- Left 10273

41,00

SWING AWAY - Lateral support

Fixing and adjustment hardware complete with protection sleeve
Aluminum lateral with padded, breathable upholstery.

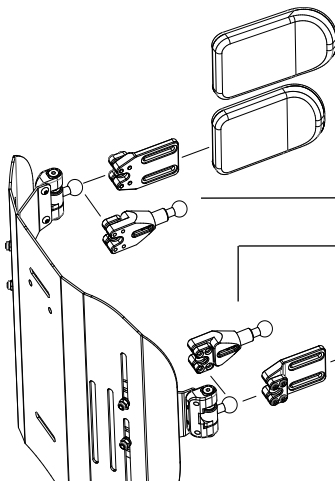

- Large (18x12)

05647 188,00

- Small (14x9)

05643 188,00

- Lateral support extension

Quantity (number pcs).....
10271 71,00

- Lateral support extension

Quantity (number pcs).....

- Small (14x9)

05642 188,00

- Large (18x12)

05646 188,00

- Headrest adjustable - Double ball mounting system
Available only with backrest Physio Posture

- Large (34x14)
- Small (28x14)



05648 295,00

| | | | |
|------------|-------------|------------|---------------|
| Date | Order | User | Address |
|------------|-------------|------------|---------------|





Note

| | | |
|---|-------------------------------|--|
| Wheelchair : Progeo EXELLE VARIO - Rev. 2024.2 | Prices - VAT excluded | Send this page only if any optional have been chosen |
| | to be added to the price list | <input type="checkbox"/> standard (supplied if no requests are indicated) |
| | | <input type="checkbox"/> on request (without extra charge) |
| | | <input type="checkbox"/> optional (cost to be added at the basic price) |

REFERENCE TABLES

Permobil Limited Unit 7, Polaris Centre, 41 Brownfields, Welwyn Garden City, Herts, AL7 1AN United Kingdom - Phone: +44 1484 722888

| 1 | Front height | |
|--|--------------|-----|
| With closed frame (95°) max 5" caster | | |
| Casters | Front height | |
| | min. | max |
| 3" | 41 | 52 |
| 4" | 42 | 53 |
| 5" | 44 | 54 |
| 6" | 48 | 55 |
| 7" | 50 | 56 |
| The size of the fork will be defined only by Progeo in accordance with wheelchair final configuration. | | |

| 2 | Rear height | | | | |
|-------------|--|-------------------|-------------------|-------------------|-------------------|
| | Rear frame | Rear wheels | | | |
| | | 22" | 24" | 25" | 26" |
| STANDARD | Straight plate  | min. 37 max 45 | min. 39 max 47 | min. 40 max 48 | min. 41 max 49 |
| | Shaped plate  | min. 36 max 49 | min. 38 max 51 | min. 39 max 52 | min. 40 max 53 |
| | Rear wheels plate extension  | min. 37 max 46 | min. 39 max 48 | min. 40 max 50 | min. 41 max 51 |
| DYNAMIC 2.0 | with Tubular armrests  | min. 36 max 49 | min. 38 max 51 | min. 39 max 52 | min. 40 max 53 |

| 3 | Footplate option | Frame Angle 110° | Footplate distance Frame Angle 120° | Frame Angle 95° |
|---|---|------------------|--|-----------------|
| | Plastic footrest | min. 27 | min. 27 | min. 27 |
| | One piece footplate - Flip-up! | min. 24 | min. 26 | min. 24 |
| | One piece footplate - Flip-up! , with multifunction rotative system | min. 19 | min. 21 | min. 19 |
| | One piece aluminium footplate - Flip-up! | min. 24 | min. 26 | min. 24 |
| | One piece Carbon fibre footplate | min. 24 | min. 26 | min. 24 |
| Calculated with the best configuration and with the footplates positioned on inside. | | | | |
| IMPORTANT NOTICE! From the footplate to the floor minimum 4cm !! (Minimum Front height = DP + 4cm) | | | | |

| 4 | Rear wheels | |
|---|-------------------------------------|--|
| | Model | Features |
| | 22" Ultra-light Progeo - Standard! | (not available in anthracite color) |
| | 24" Ultra-light Progeo - Standard! | (available for all colors) |
| | 24" ULTRA-LIGHT PROGEO KEY SPORT | (silver hub, black rim and 16 spokes) |
| | 24" Ultra-light "Spinergy LX" | (silver hub, black rim and spokes) |
| | 24" Ultra-light "Spinergy LXL" | (black hub and rim, 18 white spokes) - (black hub, rim and 18 spokes) |
| | 24" Ultra-light "Spinergy Flex rim" | (silver hub, black rim and spokes) - (integrated aluminium/rubber handrim - encumbrance reduction up to 3cm. - all tyre) |
| | 24" Off-road | (colour: black) - (aluminium handrim - tyre Off-road) |
| | 25" Ultra-light "Spinergy LX" | (silver hub, black rim and spokes) |
| | 25" Ultra-light "Spinergy LXL" | (black hub and rim, 18 white spokes) |
| | 26" Progeo - Standard! | (colour: black) |
| | 26" Ultra-light "Spinergy LX" | (silver hub, black rim and 18 spokes) |