

Fitting / Order form

F5 Corpus VS (PPP)

Prices valid from: Jan-24



F5 Corpus VS (PPP)

Front wheel drive standing chair with Power Platform and Quick Configurator As standard, equipped with pneumatic or solid tyres, 85ah maintenance free batteries, charger and 12km/h top speed.

The F5 Corpus VS is equipped with bio-mechanical powered backrest, elevating and articulating leg rests, seat elevation & anterior/posterior tilt as standard. The F5VS can be accessorised with direct mount ROHO Agility backs and Bodilink accessories

Dealer information	
Customer (name / code)	/
Contact	
Address	
Post code / City	/
Phone / Fax	/
Client Information	
Name	/
Address	
Post code / City	/
Phone	
E-mail	

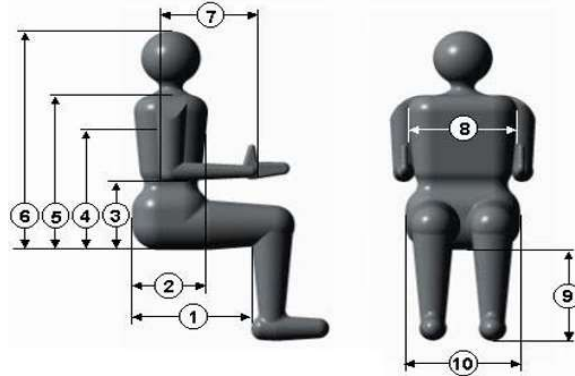







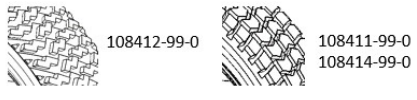

Anatomic Dimension







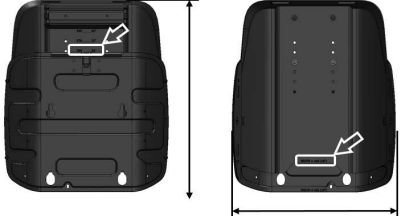















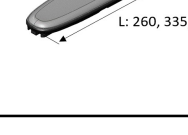
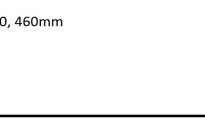
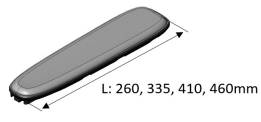

Diagnosis	Weight:	kg	3:	cm	7:	cm
	Height:	cm	4:	cm	8:	cm
			1:	cm	5:	cm
			2:	cm	6:	cm
					9:	cm
					10:	cm

Fitting date							<input checked="" type="checkbox"/> Required choice <input type="checkbox"/> / <input type="radio"/> Optional choice <input type="checkbox"/> / <input checked="" type="radio"/> Default required option	
Article code	Position	Price excl VAT	Price incl VAT	Funding code	Additional Info			

Chassis								
F5 CORPUS VS	108851-99-0	<input checked="" type="checkbox"/>	26300.00					
PROTECTION PLAN F5/M VS	109390-99-0	<input type="checkbox"/>	1500.00					
MAX SPEED 12KMH	107306-99-0	<input checked="" type="radio"/>	0.00					
MAX SPEED 10KMH	107305-99-0	<input type="radio"/>	0.00					
Mud guards rear <input type="radio"/>								
MUDGUARD KIT	108445-99-0	<input type="checkbox"/>	90.00					

Accent colour					
Chassis / Wheels (no charge)					
COVER ACCENT COLOUR AQUA	108432-99-0	<input type="radio"/>	<input type="radio"/>	0.00	
COVER ACCENT COLOUR SKY	108433-99-0	<input type="radio"/>	<input type="radio"/>	0.00	
COVER ACCENT COLOUR VIOLET	108434-99-0	<input type="radio"/>	<input type="radio"/>	0.00	
COVER ACCENT COLOUR FLAMINGO	108435-99-0	<input type="radio"/>	<input type="radio"/>	0.00	
COVER ACCENT COLOUR CHILI	109327-99-0	<input type="radio"/>	<input type="radio"/>	0.00	
COVER ACCENT COLOUR CANARY	108437-99-0	<input type="radio"/>	<input type="radio"/>	0.00	
COVER ACCENT COLOUR SPRING	108438-99-0	<input type="radio"/>	<input type="radio"/>	0.00	
COVER ACCENT COLOUR ARCTIC	108439-99-0	<input type="radio"/>	<input type="radio"/>	0.00	
COVER ACCENT COLOUR SUNSET	108440-99-0	<input type="radio"/>	<input type="radio"/>	0.00	
COVER ACCENT COLOUR MIDNIGHT	108441-99-0	<input type="radio"/>	<input type="radio"/>	0.00	
COVER ACCENT COLOUR GOLD	108442-99-0	<input type="radio"/>	<input type="radio"/>	143.00	
COVER ACCENT COLOUR BRONZE	108443-99-0	<input type="radio"/>	<input type="radio"/>	143.00	
COVER ACCENT COLOUR PLATINUM	108444-99-0	<input type="radio"/>	<input type="radio"/>	143.00	
Drive wheels					
WHEELS 3.00x8" AIR FILLED TIRES BLACK	108411-99-0	<input checked="" type="radio"/>	<input type="radio"/>	0.00	
WHEELS 3.00x8" SOLID TIRES BLACK	108414-99-0	<input type="radio"/>	<input type="radio"/>	0.00	
WHEELS 3.00x8" AIR FILLED TIRES/SNOW AND MUD BLACK	108412-99-0	<input type="radio"/>	<input type="radio"/>	0.00	
					
Caster wheels					
WHEELS 210X65 AIR FILLED TIRES BLACK	108408-99-0	<input checked="" type="radio"/>	<input type="radio"/>	0.00	
WHEELS 210X65 SOLID TIRES BLACK	108409-99-0	<input type="radio"/>	<input type="radio"/>	0.00	
Batteries					
BATTERIES, 85Ah, SET OF 2 PERMOBIL	108999-99-0	<input checked="" type="radio"/>	<input type="radio"/>	0.00	
WITHOUT BATTERIES	100661-99-0	<input type="radio"/>	<input type="radio"/>	0.00	
Charger					
CHARGER VOLTPRO 24/10 PERMOBIL GEL-AGM IP44 EU	109166-99-0	<input checked="" type="radio"/>	<input type="radio"/>	0.00	
WITHOUT CHARGER	100662-99-0	<input type="radio"/>	<input type="radio"/>	0.00	
Light kit					
LIGHT KIT	109385-99-0	<input checked="" type="radio"/>	<input type="radio"/>	435.00	
REFLECTOR KIT	108415-99-0	<input type="radio"/>	<input type="radio"/>	0.00	
Anti-tippers					
ANTI TIPPER WHEELS	107027-99-0	<input checked="" type="checkbox"/>	<input type="checkbox"/>	0.00	
					
Accessories chassis					
LUGGAGE CARRIER WITH REFLECTORS	109170-99-0	<input type="radio"/>	<input type="radio"/>	313.00	
LUGGAGE CARRIER WITH TAIL LIGHTS	109169-99-0	<input type="radio"/>	<input type="radio"/>	525.00	
WITHOUT LUGGAGE CARRIER	109284-99-0	<input checked="" type="radio"/>	<input type="radio"/>	0.00	
MOUNTDAHL LOCKING PLATE	109019-99-0	<input type="radio"/>	<input type="radio"/>	557.00	
PREPARED FOR DAHL CARLOCK	108254-99-0	<input type="radio"/>	<input type="radio"/>	167.00	
OPTION NOT REQUIRED		<input checked="" type="radio"/>	<input type="radio"/>		
REMOTE STOP (2CH)433MHZ (EU)	110285-99-0	<input type="checkbox"/>	<input type="checkbox"/>	604.00	
TARPAULIN/RAINCOVER FOR ALL MODLES (NYLON)	101888-99-0	<input type="radio"/>	<input type="radio"/>	138.00	
TARPAULIN/RAINCOVER YELLOW (WATERPROOF)	101897-99-0	<input type="radio"/>	<input type="radio"/>	313.00	
OPTION NOT REQUIRED		<input checked="" type="radio"/>	<input type="radio"/>		
					
Seat assembly					
POWERED (AP) ELEVATOR VS-PP	110243-99-0	<input checked="" type="checkbox"/>	<input type="checkbox"/>	0.00	
POWERED ADJ.SEAT TILT 50°	107095-99-0	<input checked="" type="radio"/>	<input type="radio"/>	0.00	
FIXED SEAT ANGEL	107096-99-0	<input type="radio"/>	<input type="radio"/>	0.00	
					



Seat															
SEAT CORPUS VS		108847-99-0		<input checked="" type="checkbox"/>		0.00									
Seat sizes															
		Depth													
Size (mm)		370 14"	395 15"	420 16"	445 17"	470 18"	495 19"	520 20"	545 21"	570 22"					
Width	420mm/16"	<input type="checkbox"/>	<input type="checkbox"/>	<input type="checkbox"/>	<input type="checkbox"/>	<input type="checkbox"/>	<input type="checkbox"/>	<input type="checkbox"/>	<input type="checkbox"/>	<input type="checkbox"/>					
	470mm/18"	<input type="checkbox"/>	<input type="checkbox"/>	<input type="checkbox"/>	<input type="checkbox"/>	<input type="checkbox"/>	<input type="checkbox"/>	<input type="checkbox"/>	<input type="checkbox"/>	<input type="checkbox"/>					
	520mm/20"	<input type="checkbox"/>	<input type="checkbox"/>	<input type="checkbox"/>	<input type="checkbox"/>	<input type="checkbox"/>	<input type="checkbox"/>	<input type="checkbox"/>	<input type="checkbox"/>	<input type="checkbox"/>					
	570mm/22"	<input type="checkbox"/>	<input type="checkbox"/>	<input type="checkbox"/>	<input type="checkbox"/>	<input type="checkbox"/>	<input type="checkbox"/>	<input type="checkbox"/>	<input type="checkbox"/>	<input type="checkbox"/>					
<input type="checkbox"/> No matching seat cushion size															
Seat cushion															
SEAT CUSHION CORPUS ERGO VINYL		10XXXX-99-0		<input checked="" type="checkbox"/>		0.00									
SEAT CUSHION CORPUS ERGO STRETCH AIR		10XXXX-99-0		<input type="checkbox"/>		0.00									
WITHOUT SEAT CUSHION		105118-99-0		<input type="checkbox"/>		-101.00									
ERGO SUPPORTS SEAT CUSHION		105219-99-0		<input checked="" type="checkbox"/>		0.00									
Adjustment backrest															
POWERED ADJ. BACKREST 180° (LA28)		107756-99-0		<input checked="" type="checkbox"/>		0.00									
BACKREST FIXED		105066-99-0		<input checked="" type="checkbox"/>		0.00									
BACKREST BIO-MECH		107030-99-0		<input type="checkbox"/>		0.00									
Backrest type															
SHORT		107262-99-0		<input type="checkbox"/>		0.00									
STANDARD		107264-99-0		<input checked="" type="checkbox"/>		0.00									
WITHOUT BACKREST SHELL		107272-99-0		<input type="checkbox"/>		-133.00									
Backrest sizes															
		Short	Standard heights												
Size (mm)		470	545	570	595	620	645	670							
Width	360	<input type="checkbox"/>	<input type="checkbox"/>	<input type="checkbox"/>	<input type="checkbox"/>	<input type="checkbox"/>	<input type="checkbox"/>	<input type="checkbox"/>							
	410	<input type="checkbox"/>	<input type="checkbox"/>	<input type="checkbox"/>	<input checked="" type="checkbox"/>	<input type="checkbox"/>	<input type="checkbox"/>	<input type="checkbox"/>							
	460	<input type="checkbox"/>	<input type="checkbox"/>	<input type="checkbox"/>	<input type="checkbox"/>	<input type="checkbox"/>	<input type="checkbox"/>	<input type="checkbox"/>							
	510	<input type="checkbox"/>	<input type="checkbox"/>	<input type="checkbox"/>	<input type="checkbox"/>	<input type="checkbox"/>	<input type="checkbox"/>	<input type="checkbox"/>							
Backrest cushion															
BACKREST CUSHION VINYL		10XXXX-99-0		<input checked="" type="checkbox"/>		0.00		 <p>5 cm: 105569-99-0 109158-99-9 7 cm: 105570-99-0 109157-99-0</p>							
BACKREST CUSHION STRETCH AIR		10XXXX-99-0		<input type="checkbox"/>		0.00									
WITHOUT BACKREST CUSHION		105117-99-0		<input type="checkbox"/>		-101.00									
ERGO SUPPORTS BACK SMALL (5 CM DEEP)		105569-99-0		<input checked="" type="checkbox"/>		0.00									
ERGO SUPPORTS BACK LARGE (7 CM DEEP)		105570-99-0		<input type="checkbox"/>		0.00									
Agility Max Contour															
		(H)	Height			(MH)	Mounting height								
		(W)	Size ("/mm)	16"	18"	20"		16"	18"						20"
Width	14"/355mm	<input type="checkbox"/>	<input type="checkbox"/>	<input type="checkbox"/>		470mm	<input type="checkbox"/>	<input type="checkbox"/>	<input type="checkbox"/>						
	15"/380mm	<input type="checkbox"/>	<input type="checkbox"/>	<input type="checkbox"/>		495mm	<input type="checkbox"/>	<input type="checkbox"/>	<input type="checkbox"/>						
	16"/405mm	<input type="checkbox"/>	<input type="checkbox"/>	<input type="checkbox"/>		520mm	<input type="checkbox"/>	<input type="checkbox"/>	<input type="checkbox"/>						
	17"/430mm	<input type="checkbox"/>	<input type="checkbox"/>	<input type="checkbox"/>		545mm	<input type="checkbox"/>	<input type="checkbox"/>	<input type="checkbox"/>						
	18"/455mm	<input type="checkbox"/>	<input type="checkbox"/>	<input type="checkbox"/>		570mm	<input type="checkbox"/>	<input type="checkbox"/>	<input type="checkbox"/>						
	19"/485mm	<input type="checkbox"/>	<input type="checkbox"/>	<input type="checkbox"/>		595mm	<input type="checkbox"/>	<input type="checkbox"/>	<input type="checkbox"/>						
	20"/510mm	<input type="checkbox"/>	<input type="checkbox"/>	<input type="checkbox"/>		620mm	<input type="checkbox"/>	<input type="checkbox"/>	<input type="checkbox"/>						
OPTION NOT REQUIRED			<input checked="" type="checkbox"/>	<input type="checkbox"/>	<input type="checkbox"/>	645mm	<input type="checkbox"/>	<input type="checkbox"/>	<input type="checkbox"/>						
890.00															

Chest support											
CHEST SUPPORT HOLDER FIXED	107174-99-0	<input type="radio"/>	0.00								
CHEST SUPPORT HOLDER ADJUSTABLE	107203-99-0	<input checked="" type="radio"/>	127.00								
CHEST SUPPORT SMALL (260MM) TEXTILE	107177-99-0	<input type="radio"/>	0.00								
CHEST SUPPORT MEDIUM (310MM) TEXTILE	107176-99-0	<input checked="" type="radio"/>	0.00								
CHEST SUPPORT LARGE (360MM) TEXTILE	107175-99-0	<input type="radio"/>	0.00								
Mounting armrests											
WIDTH BETWEEN ARMRESTS: NARROW (38-48CM)	107251-99-0	<input checked="" type="radio"/>	0.00								
WIDTH BETWEEN ARMRESTS: WIDE (48-58CM)	107252-99-0	<input type="radio"/>	0.00								
WIDTH BETWEEN ARMRESTS SET TO 380MM	105083-99-0	<input type="radio"/>	0.00								
WIDTH BETWEEN ARMRESTS SET TO 430MM	105084-99-0	<input checked="" type="radio"/>	0.00								
WIDTH BETWEEN ARMRESTS SET TO 480MM	105085-99-0	<input type="radio"/>	0.00								
WIDTH BETWEEN ARMRESTS SET TO 530MM	105086-99-0	<input type="radio"/>	0.00								
WIDTH BETWEEN ARMRESTS SET TO 580MM	105082-99-0	<input type="radio"/>	0.00								
ARMREST HEIGHT POS 2: 255MM (FROM SEAT PAN)	106632-99-0	<input type="radio"/>	0.00								
ARMREST HEIGHT POS 3: 280MM (FROM SEAT PAN)	106633-99-0	<input checked="" type="radio"/>	0.00								
ARMREST HEIGHT POS 4: 305MM (FROM SEAT PAN)	106634-99-0	<input type="radio"/>	0.00								
ARMREST HEIGHT POS 5: 330MM (FROM SEAT PAN)	106635-99-0	<input type="radio"/>	0.00								
Armrests											
		Left		Right							
		260	335	410	460	260	335	410	460		
WITHOUT ARMREST		<input type="radio"/>	<input type="radio"/>	<input type="radio"/>	<input type="radio"/>	<input type="radio"/>	<input type="radio"/>	<input type="radio"/>	<input type="radio"/>	-45.00	
TEXTILE ARMREST		<input type="radio"/>	<input type="radio"/>	<input type="radio"/>	<input type="radio"/>	<input type="radio"/>	<input type="radio"/>	<input type="radio"/>	<input type="radio"/>	0.00	
VINYL ARMREST		<input type="radio"/>	<input checked="" type="radio"/>	<input type="radio"/>	<input type="radio"/>	<input type="radio"/>	<input checked="" type="radio"/>	<input type="radio"/>	<input type="radio"/>	0.00	
GEL ARMREST		<input type="radio"/>	<input type="radio"/>	<input type="radio"/>	<input type="radio"/>	<input type="radio"/>	<input type="radio"/>	<input type="radio"/>	<input type="radio"/>	148.00	EACH
											
Adjustment legrest											
POWERED ADJ. LEGREST CORPUS VS (LA28)	107760-99-0	<input checked="" type="checkbox"/>	0.00								
Legrest											
LEGREST	106965-99-0	<input checked="" type="checkbox"/>	0.00								
Footplates											
DUAL FOOTPLATE 16CM LEG LENGTH 25-50CM (PWR)	106967-99-0	<input type="radio"/>	0.00								
DUAL FOOTPLATE 16CM LEG LENGTH 25-50CM (PWR)COMP	109359-99-0	<input checked="" type="radio"/>	0.00								
DUAL FOOTPLATE 20CM LEG LENGTH 25-50CM (PWR FOOT)	106971-99-0	<input type="radio"/>	0.00								
FOOTPLATE 1P. 42CM LEG LENGTH 25-50CM (PWR FOOT)	106969-99-0	<input type="radio"/>	0.00								
DUAL FOOTPLATE 16CM LEG LENGTH <25CM (PWR)	106966-99-0	<input type="radio"/>	0.00								
DUAL FOOTPLATE 16CM LEG LENGTH <25CM (PWR)COMP	109360-99-0	<input type="radio"/>	0.00								
DUAL FOOTPLATE 20CM LEG LENGTH <25CM (PWR FOOT)	106970-99-0	<input type="radio"/>	0.00								
FOOTPLATE 1P. 42CM LEG LENGTH <25CM (PWR FOOT)	106968-99-0	<input type="radio"/>	0.00								
						106969-99-0 1x420mm					
						106968-99-0 1x420mm					
Knee support											
KNEE SUPPORTS SWING AWAY LARGE (VS/130*330MM)	109950-99-0	<input type="radio"/>	0.00								
KNEE SUPPORTS SWING AWAY SMALL (VS/114*316MM)	109951-99-0	<input type="radio"/>	0.00								
KNEE SUPPORT WITH TEXTIEL UPHOLSTERY	107038-99-0	<input type="radio"/>	0.00								
						109950-99-0 109951-99-0					
						107038-99-0					

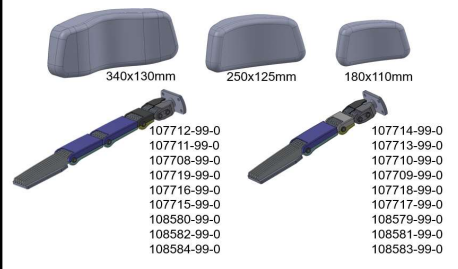
Accessories seat					
Headrest					
Corpus					
HEAD SUPPORT, ADJUSTABLE TEXTILE(BLACK)	106336-99-0	<input type="radio"/>	235.00		
HEAD SUPPORT, ADJUSTABLE VINYL	106331-99-0	<input type="radio"/>	235.00		
HEAD SUPPORT "ERGO" TEXTILE(BLACK)	106333-99-0	<input type="radio"/>	235.00		
HEAD SUPPORT "ERGO"	106332-99-0	<input type="radio"/>	235.00		
BODILINK HEADREST L MAX 8 STD BACK	108719-99-0	<input type="radio"/>	419.00		
BODILINK HEADREST L MAX 8 LOW BACK	108720-99-0	<input type="radio"/>	419.00		
BODILINK HEADREST M MAX 8 STD BACK	108717-99-0	<input type="radio"/>	419.00		
BODILINK HEADREST M MAX 8 LOW BACK	108718-99-0	<input type="radio"/>	419.00		
BODILINK HEADREST S MAX 8 STD BACK	109003-99-0	<input type="radio"/>	419.00		
BODILINK HEADREST S MAX 8 LOW BACK	109004-99-0	<input type="radio"/>	419.00		
HEADREST ORIGINAL 340x130 LONG HOLDER, STD BACK	107716-99-0	<input type="radio"/>	371.00		
HEADREST ORIGINAL 340x130 LONG HOLDER, SHORT BACK	107715-99-0	<input type="radio"/>	371.00		
HEADREST ORIGINAL 340x130 STD HOLDER, STD BACK	107718-99-0	<input type="radio"/>	371.00		
HEADREST ORIGINAL 340x130 STD HOLDER, SHORT BACK	107717-99-0	<input type="radio"/>	371.00		
HEADREST ORIGINAL 250x125 LONG HOLDER, STD BACK	107708-99-0	<input type="radio"/>	371.00		
HEADREST ORIGINAL 250x125 LONG HOLDER, SHORT BACK	107719-99-0	<input type="radio"/>	371.00		
HEADREST ORIGINAL 250x125 STD HOLDER, STD BACK	107710-99-0	<input type="radio"/>	371.00		
HEADREST ORIGINAL 250x125 STD HOLDER, SHORT BACK	107709-99-0	<input type="radio"/>	371.00		
HEADREST ORIGINAL 180x110 LONG HOLDER, STD BACK	107712-99-0	<input type="radio"/>	371.00		
HEADREST ORIGINAL 180x110 LONG HOLDER, SHORT BACK	107711-99-0	<input type="radio"/>	371.00		
HEADREST ORIGINAL 180x110 STD HOLDER, STD BACK	107714-99-0	<input type="radio"/>	371.00		
HEADREST ORIGINAL 180x110 STD HOLDER, SHORT BACK	107713-99-0	<input type="radio"/>	371.00		
Facial support pad / switch Left					
SWING AWAY FACIAL SUPPORT STANDARD LEFT/HIGH	107860-99-0	<input type="radio"/>	350.00		
SWING AWAY FACIAL SUPPORT LONG LEFT/HIGH	107861-99-0	<input type="radio"/>	350.00		
SWING AWAY ASSY W. EGG SW F. HEADREST LEFT/HIGH	107858-99-0	<input type="radio"/>	471.00		
SWING AWAY ASSY W. TASH MICRO LIGHT LEFT/HIGH	107859-99-0	<input type="radio"/>	496.00		
OPTION NOT REQUIRED		<input checked="" type="radio"/>			
Facial support pad / switch Right					
SWING AWAY FACIAL SUPPORT STANDARD RIGHT/HIGH	107941-99-0	<input type="radio"/>	350.00		
SWING AWAY FACIAL SUPPORT LONG RIGHT/HIGH	107944-99-0	<input type="radio"/>	350.00		
SWING AWAY ASSY W. EGG SW F. HEADREST RIGHT/HIGH	107931-99-0	<input type="radio"/>	471.00		
SWING AWAY ASSY W. TASH MICRO LIGHT RIGHT/HIGH	107935-99-0	<input type="radio"/>	496.00		
OPTION NOT REQUIRED		<input checked="" type="radio"/>			
Extension cable					
EXTENSION CABLE 3MM STEREO, L=1M	105931-99-0	<input type="radio"/>	52.00		
EXTENSION CABLE 3MM STEREO, L=2M	105932-99-0	<input type="radio"/>	52.00		
OPTION NOT REQUIRED		<input checked="" type="radio"/>			

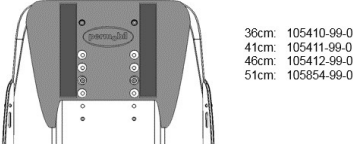

Lateral support					
Corpus					
BODILINK LATERAL SUPP. L. STRETCH-AIR 75X140	109025-99-0	<input type="radio"/>		265.00	
BODILINK LATERAL SUPP. L. STRETCH-AIR 100X165	109027-99-0	<input type="radio"/>		265.00	
BODILINK LATERAL SUPP. R. STRETCH-AIR 75X140	109026-99-0	<input type="radio"/>	<input type="radio"/>	265.00	
BODILINK LATERAL SUPP. R. STRETCH-AIR 100X165	109028-99-0	<input type="radio"/>	<input type="radio"/>	265.00	
LATERAL SUPPORT ORIGINAL LEFT 180X130	107720-99-0	<input type="radio"/>		239.00	
LATERAL SUPPORT ORIGINAL LEFT 130X80	107722-99-0	<input type="radio"/>		239.00	
LATERAL SUPPORT ORIGINAL RIGHT 180X130	107721-99-0	<input type="radio"/>	<input type="radio"/>	239.00	
LATERAL SUPPORT ORIGINAL RIGHT 130X80	107723-99-0	<input type="radio"/>	<input type="radio"/>	239.00	
OPTION NOT REQUIRED		<input type="radio"/>	<input type="radio"/>		
Thigh supports					
BODILINK THIGH SUPPORT L. STRETCH-AIR 90X110 S(B)	109179-99-0	<input type="radio"/>		207.00	
BODILINK THIGH SUPPORT L. STRETCH-AIR 200X90 L(C)	109181-99-0	<input type="radio"/>		207.00	
BODILINK THIGH SUPPORT L. STRETCH-AIR 300x90 XL(G)	109036-99-0	<input type="radio"/>		207.00	
BODILINK THIGH SUPPORT R. STRETCH-AIR 90X110 S(B)	109180-99-0	<input type="radio"/>	<input type="radio"/>	207.00	
BODILINK THIGH SUPPORT R. STRETCH-AIR 200X90 L(C)	109182-99-0	<input type="radio"/>	<input type="radio"/>	207.00	
BODILINK THIGH SUPPORT R. STRETCH-AIR 300x90 XL(G)	109037-99-0	<input type="radio"/>	<input type="radio"/>	207.00	
THIGH SUPPORT LEFT TEXTILE 110x90 SMALL (B)	107392-99-0	<input type="radio"/>		159.00	
THIGH SUPPORT LEFT TEXTILE 165x120 MEDIUM (J)	107396-99-0	<input type="radio"/>		159.00	
THIGH SUPPORT LEFT TEXTILE 200x90 LARGE (C)	107394-99-0	<input type="radio"/>		159.00	
THIGH SUPPORT LEFT TEXTILE 300x90 XLARGE (G)	107390-99-0	<input type="radio"/>		159.00	
THIGH SUPPORT RIGHT TEXTILE 110x90 SMALL (B)	107393-99-0	<input type="radio"/>	<input type="radio"/>	159.00	
THIGH SUPPORT RIGHT TEXTILE 165x120 MEDIUM (J)	107397-99-0	<input type="radio"/>	<input type="radio"/>	159.00	
THIGH SUPPORT RIGHT TEXTILE 200x90 LARGE (C)	107395-99-0	<input type="radio"/>	<input type="radio"/>	159.00	
THIGH SUPPORT RIGHT TEXTILE 300x90 XLARGE (G)	107391-99-0	<input type="radio"/>	<input type="radio"/>	159.00	
OPTION NOT REQUIRED		<input type="radio"/>	<input type="radio"/>		
Hip supports					
BODILINK HIP SUPPORT L. STRETCH-AIR 90X110 S(B)	109032-99-0	<input type="radio"/>		207.00	
BODILINK HIP SUPPORT L. STRETCH-AIR 200X90 L(C)	109034-99-0	<input type="radio"/>		207.00	
BODILINK HIP SUPPORT L. STRETCH-AIR 150X140 M(A)	109038-99-0	<input type="radio"/>		207.00	
BODILINK HIP SUPPORT R. STRETCH-AIR 90X110 S(B)	109033-99-0	<input type="radio"/>	<input type="radio"/>	207.00	
BODILINK HIP SUPPORT R. STRETCH-AIR 200X90 L(C)	109035-99-0	<input type="radio"/>	<input type="radio"/>	207.00	
BODILINK HIP SUPPORT R. STRETCH-AIR 150X140 M(A)	109039-99-0	<input type="radio"/>	<input type="radio"/>	207.00	
HIP SUPPORT LEFT TEXTILE 110x90 SMALL (B)	107400-99-0	<input type="radio"/>		159.00	
HIP SUPPORT LEFT TEXTILE 150x140 MEDIUM (A)	107398-99-0	<input type="radio"/>		159.00	
HIP SUPPORT LEFT TEXTILE 200x90 LARGE (C)	107402-99-0	<input type="radio"/>		159.00	
HIP SUPPORT LEFT TEXTILE 200x200 XLARGE (D)	107404-99-0	<input type="radio"/>		159.00	
HIP SUPPORT RIGHT TEXTILE 110x90 SMALL (B)	107401-99-0	<input type="radio"/>	<input type="radio"/>	159.00	
HIP SUPPORT RIGHT TEXTILE 150x140 MEDIUM (A)	107399-99-0	<input type="radio"/>	<input type="radio"/>	159.00	
HIP SUPPORT RIGHT TEXTILE 200x90 LARGE (C)	107403-99-0	<input type="radio"/>	<input type="radio"/>	159.00	
HIP SUPPORT RIGHT TEXTILE 200x200 XLARGE (D)	107405-99-0	<input type="radio"/>	<input type="radio"/>	159.00	
OPTION NOT REQUIRED		<input type="radio"/>	<input type="radio"/>		
Calf supports					
CALF SUPPORTS S (B) 110x90 TEXT. (VS)	107210-99-0	<input type="radio"/>		254.00	
CALF SUPPORTS M (J) 165x120 TEXT. (VS)	107211-99-0	<input type="radio"/>		254.00	
CALF SUPPORTS L (A) 150x140 TEXT. (VS)	106190-99-0	<input type="radio"/>		254.00	
CALF SUPPORTS XL (H) 170x175 TEXT. (VS)	106188-99-0	<input type="radio"/>		254.00	
CALF SUPPORTS XXL (D) 200x200 TEXT. (VS)	106186-99-0	<input type="radio"/>		254.00	
OPTION NOT REQUIRED		<input type="radio"/>	<input type="radio"/>		







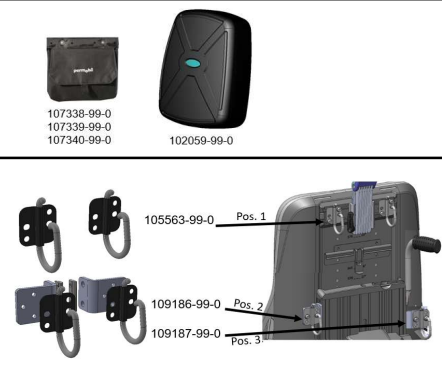
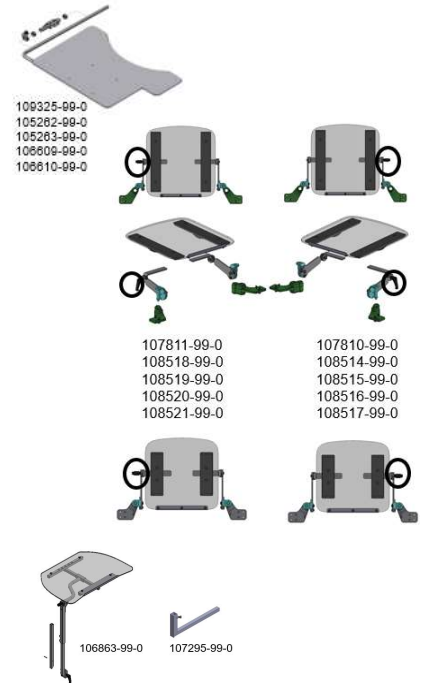















Elbow and side supports armrests					
ELBOW SUPPORT LEFT	107838-99-0	<input type="checkbox"/>	95.00		
ELBOW SUPPORT RIGHT	107839-99-0	<input type="checkbox"/>	95.00		
ARMREST SIDE SUPPORT LEFT OUTSIDE	107863-99-0	<input type="checkbox"/>	53.00		
ARMREST SIDE SUPPORT RIGHT OUTSIDE	107840-99-0	<input type="checkbox"/>	53.00		
ARMREST SIDE SUPPORT LEFT INSIDE	107865-99-0	<input type="checkbox"/>	53.00		
ARMREST SIDE SUPPORT RIGHT INSIDE	107864-99-0	<input type="checkbox"/>	53.00		
					
Shoulder support					
SHOULDER SUPPORT FOR 36CM WIDE BACKREST	105410-99-0	<input type="radio"/>	0.00		
SHOULDER SUPPORT FOR 41CM WIDE BACKREST	105411-99-0	<input type="radio"/>	0.00		
SHOULDER SUPPORT FOR 46CM WIDE BACKREST	105412-99-0	<input type="radio"/>	0.00		
SHOULDER SUPPORT FOR 51CM WIDE BACKREST	105854-99-0	<input type="radio"/>	0.00		
OPTION NOT REQUIRED		<input checked="" type="radio"/>			
					
Knee support					
HOLDER KNEE SUPPORT UNITRACK	107028-99-0	<input type="checkbox"/>	45.00		
					
Lumbar support					
LUMBAR SUPPORT,AIR	101972-99-0	<input type="checkbox"/>	191.00		
					

Seatbelts						
CHEST STRAP BODYPOINT ELASTIC LARGE	105843-99-0	<input type="radio"/>	80.00			 105845-99-0 105843-99-0
CHEST STRAP BODYPOINT ELASTIC SMALL	105845-99-0	<input type="radio"/>	80.00			
OPTION NOT REQUIRED		<input checked="" type="radio"/>				
SEATBELT, BODYPOINT 2- POINT, MEDIUM, NON-PADDED	104518-99-0	<input type="radio"/>	72.00			 Hip belts non padded  Hip belts padded Rehab Latch  Hip belts padded  4-Point R pull  100518-99-0  100519-99-0  100600-99-0  100600-99-0
SEATBELT, BODYPOINT 2- POINT, LARGE, NON-PADDED	104514-99-0	<input type="radio"/>	72.00			
SEATBELT, BODYPOINT 2- POINT, MEDIUM, PADDED	104520-99-0	<input type="radio"/>	103.00			
SEATBELT, BODYPOINT 2- POINT, LARGE, PADDED	104516-99-0	<input type="radio"/>	103.00			
SEATBELT, BODYPOINT 2- POINT, X-LARGE, PADDED	106531-99-0	<input type="radio"/>	103.00			
BP HIP BELT, 2P C PULL LATCH 46CM PAD	108267-99-0	<input type="radio"/>	103.00			
BP HIP BELT, 2P C PULL LATCH 62CM PAD	108266-99-0	<input type="radio"/>	103.00			
BP HIP BELT, 4P R PULL PUSHBUTT. 46CM PAD	108265-99-0	<input type="radio"/>	139.00			
SAFETY BELT,BUCKLE	100518-99-0	<input type="radio"/>	60.00			
SAFETY BELT,AUTOTENSION	100519-99-0	<input type="radio"/>	114.00	<input type="radio"/>		
SAFETY BELT,AUTOTENSION LONG VERSION	100600-99-0	<input type="radio"/>	114.00	<input type="radio"/>		
OPTION NOT REQUIRED		<input checked="" type="radio"/>				
SAFETY BELT,4-POINT	100529-99-0	<input type="radio"/>	145.00			 Monoflex™ Chest Support  PivotFit™ Shoulder Harness  Stayflex™ Chest Support  100529-99-0
SEATBELT, BODYPOINT MONOFLEX MEDIUM	105840-99-0	<input type="radio"/>	87.00			
SEATBELT, BODYPOINT MONOFLEX LARGE	105839-99-0	<input type="radio"/>	87.00			
SEATBELT, BODYPOINT MONOFLEX X-LARGE	105850-99-0	<input type="radio"/>	87.00			
BP HARNESS PIVOTFIT S SHOULDER SUPPORT FP	108275-99-0	<input type="radio"/>	154.00			
BP HARNESS PIVOTFIT M SHOULDER SUPPORT FP	108276-99-0	<input type="radio"/>	154.00			
BP HARNESS PIVOTFIT L SHOULDER SUPPORT FP	108277-99-0	<input type="radio"/>	154.00			
BP HARNESS PIVOTFIT XL SHOULDER SUPPORT FP	108278-99-0	<input type="radio"/>	154.00			
BP HARNESS STAYFLEX XS CHEST SUPPORT FP	108269-99-0	<input type="radio"/>	154.00			
BP HARNESS STAYFLEX S CHEST SUPPORT FP	108270-99-0	<input type="radio"/>	154.00			
BP HARNESS STAYFLEX M CHEST SUPPORT FP	108271-99-0	<input type="radio"/>	154.00			
BP HARNESS STAYFLEX L CHEST SUPPORT FP	108272-99-0	<input type="radio"/>	154.00			
BP HARNESS STAYFLEX XL CHEST SUPPORT FP	108273-99-0	<input type="radio"/>	154.00			
OPTION NOT REQUIRED		<input checked="" type="radio"/>				
FOOTSTRAPS WITH PADS (SET OF 2)	103104-99-0	<input type="radio"/>	127.00			 103104-99-0  103427-99-0  108242-99-0 108243-99-0
FOOTSTRAPS WITHOUT PADS (SET OF 2)	103427-99-0	<input type="radio"/>	42.00			
BP ANKEL HUGGERS MEDIUM	108242-99-0	<input type="radio"/>	147.00			
BP ANKEL HUGGERS LARGE	108243-99-0	<input type="radio"/>	147.00			
OPTION NOT REQUIRED		<input checked="" type="radio"/>				
Alternative seat cushions / options						
INCONTINENCE PROTECTIVE COVER		0	140.00			
SEAT CUSHION ERGO AIR		<input type="checkbox"/>	583.00			
ROHO QUADRO SELECT (Prices starting from)		<input type="checkbox"/>	674.00			
ROHO CONTOUR (Prices starting from)		<input type="checkbox"/>	674.00			
ROHO HYBRID ELITE (Prices starting from)		<input type="checkbox"/>	580.00			

Tray tables				
TABLE,SWING AWAY 550MM FOR JOYSTICK L/R	109325-99-0	<input type="radio"/>	<input type="radio"/>	371.00
TABLE,SWING AWAY 600MM FOR JOYSTICK L/R	105262-99-0	<input type="radio"/>	<input type="radio"/>	371.00
TABLE,SWING AWAY 650MM FOR JOYSTICK L/R	105263-99-0	<input type="radio"/>	<input type="radio"/>	371.00
OPTION NOT REQUIRED		<input checked="" type="checkbox"/>		
TABLE,REMOVABLE ANGLE ADJ LEFT, WIDTH 280MM	107811-99-0	<input type="radio"/>		318.00
TABLE,REMOVABLE ANGLE ADJ RIGHT, WIDTH 280MM	107810-99-0		<input type="radio"/>	318.00
TABLE,REMOVABLE ANGLE ADJ LEFT, WIDTH 330MM	108518-99-0	<input type="radio"/>		318.00
TABLE,REMOVABLE ANGLE ADJ RIGHT, WIDTH 330MM	108514-99-0		<input type="radio"/>	318.00
TABLE,REMOVABLE ANGLE ADJ LEFT, WIDTH 380MM	108519-99-0	<input type="radio"/>		318.00
TABLE,REMOVABLE ANGLE ADJ RIGHT, WIDTH 380MM	108515-99-0		<input type="radio"/>	318.00
TABLE,REMOVABLE ANGLE ADJ LEFT, WIDTH 430MM	108520-99-0	<input type="radio"/>		318.00
TABLE,REMOVABLE ANGLE ADJ RIGHT, WIDTH 430MM	108516-99-0		<input type="radio"/>	318.00
TABLE,REMOVABLE ANGLE ADJ LEFT, WIDTH 480MM	108521-99-0	<input type="radio"/>		318.00
TABLE,REMOVABLE ANGLE ADJ RIGHT, WIDTH 480MM	108517-99-0		<input type="radio"/>	318.00
TABLE,ANGLE ADJUST. 1-SIDE FIXATION	106863-99-0		<input type="radio"/>	371.00
OPTION NOT REQUIRED		<input checked="" type="checkbox"/>		
BRACKET ADDITIONAL POSITION TABLE	107295-99-0		<input type="checkbox"/>	0.00
Pouches/Bags				
ARMREST POUCH,RIGHT BLACK	107339-99-0		<input type="checkbox"/>	39.00
ARMREST POUCH,LEFT BLACK	107338-99-0	<input type="checkbox"/>		39.00
BACK PACK	102059-99-0		<input type="checkbox"/>	159.00
BACKPACK HOOKS,SET UNITRACK	105563-99-0	<input type="radio"/>		30.00
BACKPACK HOOK BACKREST PROFILE HIGH	109186-99-0	<input type="radio"/>		30.00
BACKPACK HOOK BACKREST PROFILE HIGH	109186-99-0	<input type="radio"/>		30.00
OPTION NOT REQUIRED		<input checked="" type="checkbox"/>		
POSITION LEFT BACKPACK HOOK ONLY	109189-99-0	<input type="radio"/>		0.00
POSITION RIGHT BACKPACK HOOK ONLY	109188-99-0		<input type="radio"/>	0.00
Other				
SUPPORT HANDLE ARMREST	106058-99-0	<input type="radio"/>	<input type="radio"/>	117.00
OPTION NOT REQUIRED		<input checked="" type="checkbox"/>		0.00
TRANSFER HANDLES, SET	105260-99-0		<input type="checkbox"/>	186.00
PUSH HANDLES	105292-99-0	<input type="radio"/>		172.00
PUSH HANDLES (BACKREST 360)	105795-99-0	<input type="radio"/>		172.00
OPTION NOT REQUIRED		<input checked="" type="checkbox"/>		
CUP HOLDER	106210-99-0		<input type="checkbox"/>	27.00
PHONE HOLDER X-GRIP	106806-99-0		<input type="checkbox"/>	76.00
TABLET HOLDER X-GRIP	106972-99-0		<input type="checkbox"/>	131.00



Controls					
User control					
JOYSTICK R-NET HS WITH 3.5" COLOR DISPLAY	108848-99-0	<input checked="" type="radio"/>	0.00		
JOYSTICK R-NET "EL" LED	105246-99-0	<input type="radio"/>	0.00		
JOYSTICK R-NET HEAVY DUTY WITH COLOUR DISPLAY	105700-99-0	<input type="radio"/>	1039.00		
NON STANDARD STEERING (SEE SPECIAL CONTROLS)	101352-99-0	<input type="radio"/>	0.00		
Parameters Joystick menu					
INDEPENDENT REPOSITIONING MODE (IRM)	110156-99-0	<input type="checkbox"/>	0.00		
PROGR.SET: MEM RECALL VIA JS SEAT MENU OFF	109800-99-0	<input type="checkbox"/>	0.00		
PROGR.SET: MEM SAVE VIA JS SEAT MENU OFF	109801-99-0	<input type="checkbox"/>	0.00		
PROGR.SET: SEAT FUNCTIONS VIA JS SEAT MENU OFF	109802-99-0	<input type="checkbox"/>	0.00		
PROGR.SET: STANDING "A" VIA JS SEAT MENU OFF	109803-99-0	<input type="checkbox"/>	0.00		
Joystick holder					
PANELHOLDER PARALLEL MOTION UNITRACK	107754-99-0	<input type="radio"/>	180.00		
PANELHOLDER SWING AWAY L=335MM	103473-99-0	<input type="radio"/>	0.00		
PANELHOLDER SWING AWAY L=435MM	103474-99-0	<input type="radio"/>	0.00		
PANEL HOLDER ATTENDANT LONG	107788-99-0	<input type="radio"/>	244.00		
WITHOUT PANELHOLDER	102835-99-0	<input type="radio"/>	0.00		
Height adjustable holder					
HEIGHT ADJUSTABLE RIGHT JOYSTICK HOLDER	107960-99-0	<input type="radio"/>	133.00		
HEIGHT ADJUSTABLE LEFT JOYSTICK HOLDER	107963-99-0	<input type="radio"/>	133.00		
HEIGHT ADJUSTABLE JOYSTICK HOLDER	108005-99-0	<input type="radio"/>	133.00		
OPTION NOT REQUIRED		<input checked="" type="radio"/>			
Switch box					
SWITCH BOX WITH TOGGLE SWITCHES	102799-99-0	<input type="radio"/>	625.00		
SWITCH BOX WITH PUSH BUTTONS	102798-99-0	<input type="radio"/>	625.00		
WITHOUT SWITCH BOX	104621-99-0	<input checked="" type="radio"/>	0.00		
Bracket switch box					
BRACKET SWITCH BOX JOYSTICK	103469-99-0	<input type="radio"/>	0.00		
BRACKET SWITCH BOX UNITRACK ARMREST	104651-99-0	<input type="radio"/>	42.00		
BRACKET SWITCH BOX BACKREST	106256-99-0	<input type="radio"/>	42.00		
SWITCH BOX NOT MOUNTED	105409-99-0	<input checked="" type="radio"/>	0.00		
Layout switch box					
SWITCHBOX(1) LAYOUT "A": SINGLE LAYER (STD)	108794-99-0	<input checked="" type="radio"/>	0.00		
SWITCHBOX(1) LAYOUT "B": SINGLE LAYER, MEM	108795-99-0	<input type="radio"/>	0.00		
SWITCHBOX(1) LAYOUT "C": SWAP LAYERS, MEM	108796-99-0	<input type="radio"/>	0.00		
SWITCHBOX(1) LAYOUT "D": SINGLE LAYER (ALT SEQ)	108797-99-0	<input type="radio"/>	0.00		
SWITCHBOX(1) LAYOUT "E": SINGLE LAYER, NO TILT	108798-99-0	<input type="radio"/>	0.00		
SWITCHBOX(1) LAYOUT "F": SINGLE STAND, SWAP, MEM	108799-99-0	<input type="radio"/>	0.00		
SWITCHBOX(1) LAYOUT "G": DUAL STAND, SWAP, MEM	108800-99-0	<input type="radio"/>	0.00		
SWITCHBOX(1) LAYOUT "L": SWAP, MEM, 5 OPTIONS	108801-99-0	<input type="radio"/>	0.00		
Indication level switch box					
SWITCHBOX(1) IND. LEVEL 1: NONE	108802-99-0	<input type="radio"/>	0.00		
SWITCHBOX(1) IND. LEVEL 2: SEAT FUNCTION	108803-99-0	<input type="radio"/>	0.00		
SWITCHBOX(1) IND. LEVEL 3: SPEED LIMITATION	108804-99-0	<input type="radio"/>	0.00		
SWITCHBOX(1) IND. LEVEL 4: COMPLETE	108805-99-0	<input checked="" type="radio"/>	0.00		
External charging socket (required with table- or special control)					
EXTRA CHARGER CONNECTOR MOUNTED ON ACC. RAIL	104164-99-0	<input type="radio"/>	117.00		
EXTRA CHARGER CONNECTOR MOUNTED UNDER SEAT FR	104165-99-0	<input type="radio"/>	117.00		
OPTION NOT REQUIRED		<input checked="" type="radio"/>			

Lock Key								
LOCKING KEY R-NET	104620-99-0	<input type="checkbox"/>	35.00					
Alternative Joystick knobs								
JOYSTICK KNOB CHIN CUP	100960-99-0	<input type="radio"/>	37.00					
JOYSTICK KNOB T-GRIP	100961-99-0	<input type="radio"/>	37.00			100960-99-0	100961-99-0	100962-99-0
JOYSTICK KNOB BALL BIG	100962-99-0	<input type="radio"/>	37.00					
JOYSTICK KNOB SOFT BALL	100963-99-0	<input type="radio"/>	37.00			100963-99-0	100964-99-0	100965-99-0
JOYSTICK KNOB MUSHROOM	100964-99-0	<input type="radio"/>	37.00					
JOYSTICK KNOB STICK	100965-99-0	<input type="radio"/>	37.00			100963-99-0	100964-99-0	100965-99-0
JOYSTICK KNOB BALL SMALL	101165-99-0	<input type="radio"/>	37.00					
JOYSTICK KNOB STANDARD	101166-99-0	<input type="radio"/>	37.00			101165-99-0	101166-99-0	105442-99-0
JOYSTICK KNOB SOFT BALL BLACK (CONE)	105442-99-0	<input type="radio"/>	37.00					
JOYSTICK KNOB BODYPOINT 7.5CM U-SHAPED	105846-99-0	<input type="radio"/>	59.00			105846-99-0	105847-99-0	105848-99-0
JOYSTICK KNOB BODYPOINT 10CM U-SHAPED	105847-99-0	<input type="radio"/>	59.00					
JOYSTICK KNOB BODYPOINT RUBBER DOME	105848-99-0	<input type="radio"/>	54.00			105846-99-0	105847-99-0	105848-99-0
OPTION NOT REQUIRED		<input checked="" type="radio"/>	0.00					
Attendant control								
JOYSTICK ATTENDANT RNET SPEED/MODE	107321-99-0	<input type="radio"/>	519.00					
SCOOT CONTROL R-NET	109532-99-0	<input type="radio"/>	2433.00				109532-99-0	
CO-PILOT	105225-99-0	<input type="radio"/>	2100.00					
OPTION NOT REQUIRED	109532-99-0	<input checked="" type="radio"/>	0.00				105225-99-0	
Emergency switch								
EMERGENCY STOP SWITCH POWER PLATFORM	110287-99-0	<input type="checkbox"/>	207.00					110287-99-0

Supplementary accessories					
(Mounting costs can apply)					
MDT/RNET: JS COMPACT (LOW FORCE)	103892-99-0	<input type="radio"/>	1431.00		
MDT/RNET: JS COMPACT	103817-99-0	<input type="radio"/>	901.00		
MDT/RNET: MINI JOYSTICK	105289-99-0	<input type="radio"/>	2173.00		
MICRO JOYSTICK R-NET, W. 300MM RNET CABLE	109524-99-0	<input type="radio"/>	2173.00		
MULTI JOYSTICK R-NET, W. 300MM RNET CABLE	109526-99-0	<input type="radio"/>	1961.00		
ALL-ROUND JOYSTICK LIGHT RNET W. 300MM RNET CABLE	109528-99-0	<input type="radio"/>	1643.00		
ALL-ROUND JOYSTICK R-NET, W. 300MM RNET CABLE	109530-99-0	<input type="radio"/>	1049.00		
OPTION NOT REQUIRED		<input checked="" type="radio"/>			
PANEL HOLDER ATTENDANT	105210-99-0	<input type="checkbox"/>	244.00		
CHEST SUPPORT FOR TABLE CII/VII VINYL	101303-99-0	<input type="checkbox"/>	181.00		
USB OUTLET CABLE	108995-99-0	<input type="radio"/>	143.00		
OPTION NOT REQUIRED		<input checked="" type="radio"/>			
SWITCH KIT FOR COMPACT JS (CHIN)	104641-99-0	<input type="checkbox"/>	339.00		
BUDDY BUTTON BLACK 63 MM	101766-99-0	0	103.00		
BUDDY BUTTON RED 63 MM	101767-99-0	0	103.00		
BUDDY BUTTON YELLOW 63 MM	101768-99-0	0	103.00		
MICRO LIGHT SWITCH	101769-99-0	0	162.00		
MINI CUP SWITCH 24 MM	101771-99-0	0	162.00		
GRASP SWITCH	101772-99-0	0	235.00		
SATELLITE TWISTER, BLACK CABLE 30CM	109546-99-0	0	189.00		
SATELLITE TWISTER, RED CABLE 30CM	109547-99-0	0	189.00		
SATELLITE TWISTER, YELLOW CABLE 30CM	109548-99-0	0	189.00		
SATELLITE TWISTER, BLUE CABLE 30CM	109549-99-0	0	189.00		
SATELLITE TWISTER, GREEN CABLE 30CM	109550-99-0	0	189.00		
CONNECTION BOX EXTERNAL SWITCHES SEATING	104196-99-0	<input type="checkbox"/>	625.00		
CONNECTION BOX EXTERNAL SWITCHES R-NET (RBI)	104696-99-0	<input type="checkbox"/>	661.00		
HAND WARMER SET	109533-99-0	<input type="checkbox"/>	636.00		
CONE 1 HAND HAND HEATER	107363-99-0	<input type="radio"/>	170.00		
CONE 2 HANDS HAND HEATER	107364-99-0	<input type="radio"/>	260.00		
OPTION NOT REQUIRED		<input checked="" type="radio"/>			

User consent for the installation of ConnectMe

Please select one of the below options:

I consent to the installation of the ConnectMe hardware at the time of manufacture. I understand this to mean that the ConnectMe hardware will be installed and ready to activate at the time of my receipt of the wheelchair and, once activated, will include the ability to monitor how my wheelchair is functioning while active, including the use of location data. I may withdraw my consent at any time by contacting my provider or Permobil directly.

I give my consent to Permobil to contact me regarding the activation of my wheelchair for the purpose of providing support with the activation process.

Name:

Email:

Phone (optional):

Signature:

Notes

