



Date .....	Order .....	User .....	Address .....
------------	-------------	------------	---------------



**Seat**

- ☆ Seat cloth with pocket (under seat)
- Seat with tension straps 08883    **224,00**
- Carbon rigid seat 08336    **475,00**
- Pocket (under seat) [25x11x4,5] 08281    **74,00**

**Backrest adjustment and fixing system**





- ☆ Backrest with double locking (upright and folded) with rake adjustable from -4° to +16°
- Backrest with upright locking system ONLY (no locking when folded) with rake adjustable from -4° to +16°
- Fixed back(non-folding back) with rake adjustable from -4° to +16°

**Backrest**



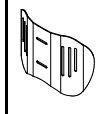

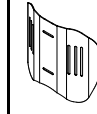
- ☆ Adjustable velcro straps and padded transpiring upholstery
- ☆ Aluminium backrest  06811    **189,00**
- Titanium backrest  04389    **749,00**
- Carbon fibre backrest  04389    **749,00**

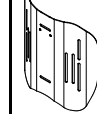
**AIR** **Integrated posture backrest (NOT REMOVABLE)** **1.047,00**

Carbon shell - Lateral retaining 7,5cm  
Depth adjustment ±1cm. - Angle adjustment ±10°  
not available for seat width 48

H 28		H 34		H 40	
Backrest Height (TS) min 34		Backrest Height (TS) min 38		Backrest Height (TS) min 44	
( ..... )		( ..... )		( ..... )	
Lateral retaining wing A=high - R=regular					
A	R	A	R	A	R
					
<input type="checkbox"/>	<input type="checkbox"/>	<input type="checkbox"/>	<input type="checkbox"/>	<input type="checkbox"/>	<input type="checkbox"/>

**Installation on:**

- ☆ Backrest tubes 
- Aluminium backrest  06811    **189,00**
- Titanium backrest  04389    **749,00**
- Carbon fibre backrest  04389    **749,00**

**Handle tube**

- ☆ Tubes with short handle
- SPORT tubes Without push handles
- Carbon fibre tubes with short handle (Lightest configuration) 04390    **148,00**  
**Not available with: Posture backrest PHYSIO - Posture backrest A I R**
- Folding handles  02958    **252,00**

**Colour set: Rear wheels and forks - To be matched only with: Rear wheels Ultra-light Progeo - Standard! (22 - 24)**

- ☆ Black 22" 24" 25" 26"    00833    **126,00**
- Bright silver 22" 24"    00833    **126,00**
- Bright orange 22" 24"    00833    **126,00**
- Bright anthracite 24"    00833    **126,00**
- Bright fuchsia 22" 24"    00833    **126,00**
- Bright blue 22" 24"    00833    **126,00**
- Bright red 22" 24"    00833    **126,00**
- Bright lime 22" 24"    00833    **126,00**
- Pearl white 22" 24"    00833    **126,00**

**Casters**



- ☆ 4" Soft
- 3" Sport (Lightest configuration)
- 5" Soft Not available with frame angle 90° to the floor
- 3" Active Soft (wide) - Aluminium alloy rim 06824    **126,00**
- 4" Active Sport (narrow) - Aluminium alloy rim 01398    **126,00**
- 4" Active Soft (wide) - Aluminium alloy rim 03943    **126,00**
- 5" Active Soft (wide) - Aluminium alloy rim Not available with frame angle 90° to the floor    07518    **126,00**
- 5" Pneumatic Not available with frame angle 90° to the floor    10844    **63,00**

Date .....	Order .....	User .....	Address .....
------------	-------------	------------	---------------

<b>Rear wheels</b>			
<input checked="" type="checkbox"/> 24" Ultra-light Progeo - Standard!			
<input type="checkbox"/> 22" Ultra-light Progeo - Standard!			
<input type="checkbox"/> 25" Ultra-light Progeo - Standard!		(colour: black)	
<input type="checkbox"/> 26" Progeo - Standard!		(colour: black)	
<input type="checkbox"/> 24" ULTRA-LIGHT PROGEO KEY SPORT		(Lightest configuration)	04383 <b>876,00</b>
<input type="checkbox"/> 24" Ultra-light "Spinergy LX"			01685 <b>876,00</b>
<input type="checkbox"/> 24" Ultra-light "Spinergy LXL"	<input type="checkbox"/> Black hub and white spokes	<input type="checkbox"/> Hub and spokes black	07846 <b>876,00</b>
<input type="checkbox"/> 24" Ultra-light "Spinergy Flex rim"	<b>Integrated aluminium/rubber handrim</b>		02270 <b>1.374,00</b>
<input type="checkbox"/> 25" Ultra-light "Spinergy LX"			02101 <b>876,00</b>
<input type="checkbox"/> 25" Ultra-light "Spinergy LXL"	<input type="checkbox"/> Black hub and white spokes		07847 <b>876,00</b>
<input type="checkbox"/> 26" Ultra-light "Spinergy LX"			02102 <b>876,00</b>
<input type="checkbox"/> 24" Off-road (aluminium handrim black)			01392 <b>224,00</b>

<b>Rear wheel tyre</b>			
<input checked="" type="checkbox"/> High pressure tyre	(22"-24"-25"-26")	(Lightest configuration)	
<input type="checkbox"/> High pressure profile tyre	(24")		
<input type="checkbox"/> Marathon Plus	(24"-25")	<b>with anti-puncture protection</b>	01669 <b>63,00</b>
<input type="checkbox"/> Anti-puncture - Colour Grey	(22")		04181 <b>98,00</b>
<input type="checkbox"/> Anti-puncture - Colour Black	(24")		11083 <b>126,00</b>

<b>Handrim</b>	<b>Wheel distance</b>	<b>★ 3 cm</b>	<b>□ 4 cm</b>		
<input checked="" type="checkbox"/> Aluminium	(22"-24"-25"-26")	(Lightest configuration)			
<input type="checkbox"/> Aluminium black SOFT-TOUCH	(24"-25")	(24" handrim, on 25" wheel is installed with spacers)		09170	<b>126,00</b>
<input type="checkbox"/> Chromed Steel	(24"-25")	(24" handrim, on 25" wheel is installed with spacers)		01684	<b>148,00</b>
<input type="checkbox"/> Titanium	(24"-25")	(24" handrim, on 25" wheel is installed with spacers)		00016	<b>275,00</b>
<input type="checkbox"/> Ultra Grepp	(24"-25")	(24" handrim, on 25" wheel is installed with spacers)		00017	<b>315,00</b>
<input type="checkbox"/> Max Grepp	(24"-25")	(24" handrim, on 25" wheel is installed with spacers)		00834	<b>349,00</b>
<input type="checkbox"/> Ergo Para	(24")			00632	<b>349,00</b>
<input type="checkbox"/> TOP FRICTION	(24"-25")	(24" handrim, on 25" wheel is installed with spacers)		11023	<b>399,00</b>
<input type="checkbox"/> Oval countour with a rubber insert					
<input type="checkbox"/> NOVA H	(24"-25")	(24" handrim, on 25" wheel is installed with spacers)		11025	<b>263,00</b>
<input type="checkbox"/> Ergonomic black profile					
<input type="checkbox"/> NOVA D	(24"-25")	(24" handrim, on 25" wheel is installed with spacers)		11026	<b>286,00</b>
<input type="checkbox"/> Ergonomic profile with rubber coating (ideal for quadriplegics)					
<input type="checkbox"/> SURGE LT	(25")	<b>Oval countour with a rubber insert</b>		06427	<b>360,00</b>
<input type="checkbox"/> Quad	(24")			00693	<b>200,00</b>
<input type="checkbox"/> Silicon cover for standard aluminium handrim		<b>Available for measures (22" - 24" - 26")</b>		04050	<b>160,00</b>



<b>Wheel locks</b>			
<input checked="" type="checkbox"/> Bent lever push to lock			
<input type="checkbox"/> Straight lever push to lock			
<input type="checkbox"/> Straight lever pull to lock			
<input type="checkbox"/> Sport brake		(Lightest configuration)	06428 <b>126,00</b>
<input type="checkbox"/> Brake with extension lever push to lock			01949 <b>63,00</b>
<input type="checkbox"/> Brake with extension lever pull to lock			03372 <b>63,00</b>



<b>Mudguard</b>			
<input checked="" type="checkbox"/> Carbon fibre mudguard			
<input type="checkbox"/> Carbon fibre Straight sideguard	<input checked="" type="checkbox"/> Aligned wheel	<input type="checkbox"/> Under wheel ..... cm	<input type="checkbox"/> Above wheel ..... cm
<input type="checkbox"/> Removable carbon fibre mudguard			04109 <b>252,00</b>
<input type="checkbox"/> Removable Carbon fibre straight sideguard	<input checked="" type="checkbox"/> Aligned wheel	<input type="checkbox"/> Under wheel ..... cm	<input type="checkbox"/> Above wheel ..... cm
<input type="checkbox"/> Welded straight mudguard	Available only with made-to-measure welded frame and fixed and welded backrest		08933 <b>372,00</b>
	<input checked="" type="checkbox"/> Aligned wheel	<input type="checkbox"/> Under wheel ..... cm	<input type="checkbox"/> Above wheel ..... cm

Date .....	Order .....	User .....	Address .....
------------	-------------	------------	---------------

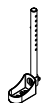
<b>Armrests</b>			
<input type="radio"/> Tubular armrests	<b>(Swing away, removable and height adjustable armrest)</b>		00694 <b>252,00</b>

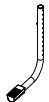
<b>Accessories</b>			
<input type="radio"/> Pad for front frame protectors			07058 <b>52,00</b>
<input type="radio"/> Backrest-seat connection cloth			10241 <b>17,00</b>
<input type="radio"/> Removable storage bag (with quick coupling)			09811 <b>126,00</b>

<b>Optional 1</b>			
<input type="checkbox"/> Set-up for post-sale optional assembly			
<input type="radio"/> Transit wheels			03290 <b>148,00</b>
<input type="radio"/> Crutches support	<input type="radio"/> Right <input type="radio"/> Left		00838 <b>74,00</b> 00837 <b>74,00</b>
<input type="radio"/> Anti-tipper with rapid hookup	<b>(inside rotation to reduce the encumbrance)</b> <input type="radio"/> Right <input type="radio"/> Left		06821 <b>126,00</b> 06822 <b>126,00</b>
<input type="radio"/> Tipping aid	<input type="radio"/> Right <input type="radio"/> Left		00025 <b>74,00</b> 01046 <b>74,00</b>

<b>Optional 2</b>			
<input type="radio"/> Push handles for companion	<b>(Removable and height adjustable)</b>		03645 <b>177,00</b>
<input type="radio"/> Tetraclip	<b>(Quick release axle for quadriplegic)</b>		03947 <b>177,00</b>
<input type="radio"/> Safety pelvic belt			03972 <b>63,00</b>
<input type="radio"/> Harness			04103 <b>126,00</b>
<input type="radio"/> Lumbar support	<b>(to insert in the backrest upholstery)</b>		00013 <b>40,00</b>
<input type="radio"/> Swing away lateral support	<input type="radio"/> Right <input type="radio"/> Left		02097 <b>252,00</b> 02098 <b>252,00</b>
<b>Not available with: Posture backrest PHYSIO - Posture backrest A I R</b>			
<input type="radio"/> Spoke guards Black	(22"-24")		01043 <b>148,00</b>
<input type="radio"/> Spoke guards Transparent	(22"-24")		00835 <b>148,00</b>
<input type="radio"/> Spoke guards Progeo design	(22"-24")		00019 <b>177,00</b>
<input type="radio"/> Spoke guards Dragon	(22"-24")		02106 <b>177,00</b>

<b>Additional Kit</b>			
<input type="radio"/> 24" Off-road rear wheels	<b>Off-Road tyre - aluminium handrim (black colour)</b>		03378 <b>498,00</b>
<input type="radio"/> 24" FAT rear wheels	<b>FAT tyre 3" - aluminium handrim (black colour)</b>		09357 <b>876,00</b>

Permobil Limited Unit 7, Polaris Centre, 41 Brownfields, Welwyn Garden City, Herts., AL7 1AN United Kingdom - Phone: +44 1484 722888

Date ..... Order ..... User ..... Address .....

**PHYSIO - Posture backrest**  
**(Std. Backrest upholstery not provided)**  
 Removable with quick release  
 Suitable for tubes with diameter 18+26mm  
 Depth adjustment (4cm)  
 Angle adjustment ( $\pm 18^\circ$ )

**AIR** Carbon shell  
 not available for seat width 48

<b>BACKREST HEIGHT</b>	<b>28</b>	<b>34</b>	<b>40</b>	<b>1.047,00</b>		
Shell's shape	Lateral retaining wing A=high - R=regular					
 7,5 cm	<b>A</b>	<b>R</b>	<b>A</b>	<b>R</b>	<b>A</b>	<b>R</b>
	<input type="checkbox"/>	<input type="checkbox"/>	<input type="checkbox"/>	<input type="checkbox"/>	<input type="checkbox"/>	<input type="checkbox"/>

**POSTURE** Aluminum shell

<b>BACKREST HEIGHT</b>	<b>34</b>	<b>40</b>	<b>52</b>	<b>1.013,00</b>
Shell's shape	Lateral retaining wing B=regular			
 7,5 cm	<b>R</b>	<b>R</b>	<b>R</b>	
	<input type="checkbox"/>	<input type="checkbox"/>	<input type="checkbox"/>	<input type="checkbox"/>

**Configuration DEEP with side support PAD (height adjustable)**

Aluminum lateral with padded, breathable upholstery.



<b>Small (h 13cm)</b>	<b>Large (h 20cm)</b>
<input type="checkbox"/> Right 10272	<input type="checkbox"/> Right 10273
<b>29,00</b>	<b>40,00</b>
<input type="checkbox"/> Left 10272	<input type="checkbox"/> Left 10273
<b>29,00</b>	<b>40,00</b>

**SWING AWAY - Lateral support**

Fixing and adjustment hardware complete with protection sleeve  
 Aluminum lateral with padded, breathable upholstery.

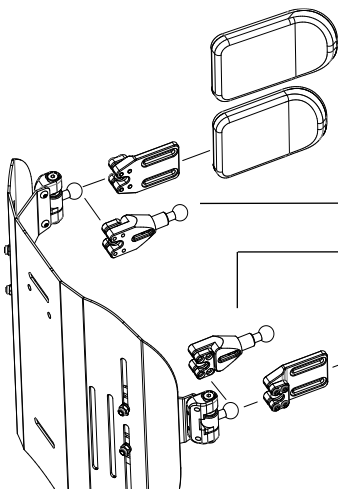

<input type="radio"/> Large (18x12)	<b>05647</b>	<b>183,00</b>
<input type="radio"/> Small (14x9)	<b>05643</b>	<b>183,00</b>
<input type="radio"/> Lateral support extension	Quantity (number pcs).....	
<input type="radio"/> Lateral support extension	<b>10271</b>	<b>69,00</b>
<input type="radio"/> Small (14x9)	<b>05642</b>	<b>183,00</b>
<input type="radio"/> Large (18x12)	<b>05646</b>	<b>183,00</b>

Headrest adjustable - Double ball mounting system

Available only with backrest Physio  
 Not available for backrest Physio AIR carbon shell



<input type="checkbox"/> Large (34x14)	<b>05648</b>	<b>252,00</b>
<input type="checkbox"/> Small (28x14)		

customer\_support\_uk@permobil.com - https://www.permobil.com/en-gb

Date ..... Order ..... User ..... Address .....

customer\_support\_uk@permobil.com - https://www.permobil.com/en-gb

1	A Footplate width			
	DP	35+39	40+45	46+50
LS				
33	21	20	19	
36	24	23	22	
39	26	25	24	
42	29	28	27	
45	32	31	30	
48	35	34	33	

2	Setting	C :
	Extremely prudential	7,5
	Prudential	9
	Standard	10,5
	Active	12
	Extreme	13,5

3	Lt
Camber	Maximum width
0°	LS + 18
2°	LS + 21
4°	LS + 24
8°	LS + 30
12°	LS + 36

Maximum width calculated including 3 cm. distance between tyre and handrim

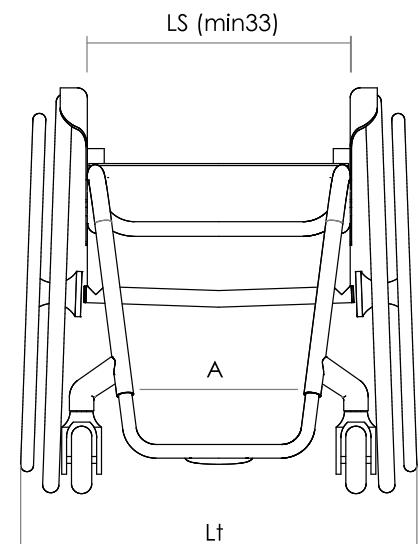
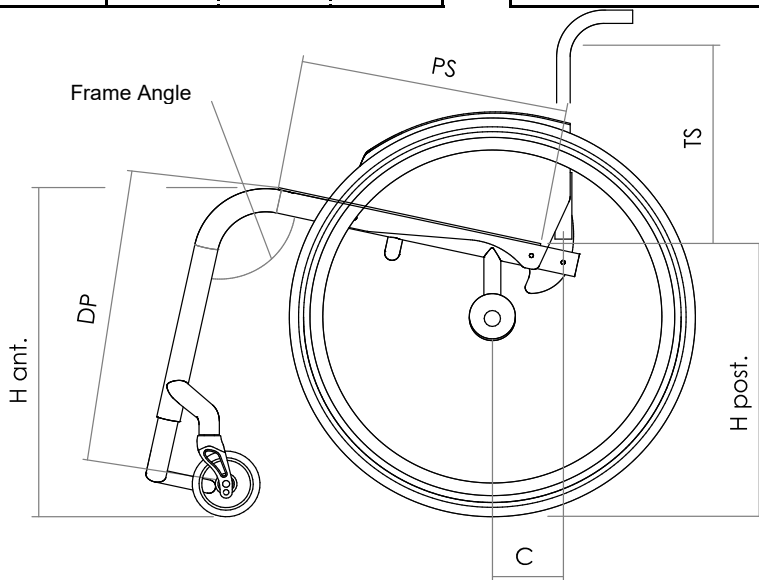

Wheelchair : Progeo JOKER ENERGY - Rev. 2023.1

Prices - VAT excluded  
to be added to the price list

**Send this page only if any optional have been chosen**

standard (supplied if no requests are indicated)

on request (without extra charge)

optional (cost to be added at the basic price)