

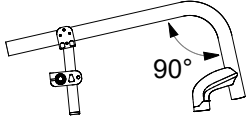

Date .....	UK (English)	
User .....	Company stamp	Rigid frame wheelchair
End user weight (kg) .....		<b>£ 3205,00</b>
Language user manual .....	Responsible .....	<b>Retail price - VAT not included</b>



Wheelchair measures						
Seat width (LS)	<input type="checkbox"/> 33	<input type="checkbox"/> 36	<input type="checkbox"/> 39	<input type="checkbox"/> 42	<input type="checkbox"/> 45	<input type="checkbox"/> 48
The seat width is measured from the outer sides of the frame, while the distance between the two side guards is 1.5 cm wider.						
Seat depth (PS)	<input type="checkbox"/> 35	<input type="checkbox"/> 37,5	<input type="checkbox"/> 40	<input type="checkbox"/> 42,5	<input type="checkbox"/> 45	<input type="checkbox"/> 47,5 <input type="checkbox"/> 50
The real seat depth, from the front part of the seat cloth to the backrest tube will be 1,5 cm more than the declared one.						
Footplate distance (DP)	..... (cm) ±0.5cm - adjustment steps 1.5cm					
<b>(Real distance between seat and footplate) - IMPORTANT NOTICE! From the footplate to the floor minimum 4cm !! (Minimum Front height = DP + 4cm.)</b>						
Setting	☆ Standard		<input type="checkbox"/> Prudential	<input type="checkbox"/> Active	<input type="checkbox"/> Extreme	
Backrest Height (TS)	Std.Value 33,5 .....(min 24.5-max 47) adjustment steps 1.5cm					
Camber	☆ 0°		<input type="checkbox"/> 2°	<input type="checkbox"/> 4°		

☆ Standard rear adjustment

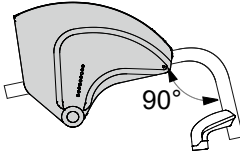
	☆ Carbon fibre mudguard <input type="checkbox"/> Carbon fibre Straight sideguard <input type="checkbox"/> Removable version	 08921 <b>126,00</b>
<input type="checkbox"/> FULL CARBON rear adjustment plate with integrated mudguard (Lightest configuration)		07646 <b>939,00</b>
	☆ Version mudguard (AVAILABLE ONLY WITH REAR WHEELS 24") <input type="checkbox"/> Version straight sideguard	

### Front height - Tick the box with the required height

The possible difference in height between HIGH frame and LOW frame is 3cm (with same fork, caster and assembly hole).

	 SPORT fork (H95)	 Small size fork (H115)
<b>LOW FRAME 90°</b> Front height (min 44,5 - max 50) Footplate distance (min 33)	Casters 3" <input type="checkbox"/> ~45 <input type="checkbox"/> ~46 4" <input type="checkbox"/> ~46 <input type="checkbox"/> ~47 5" <input type="checkbox"/> ~48,5	Casters 3" <input type="checkbox"/> ~45,5 <input type="checkbox"/> ~47 4" <input type="checkbox"/> ~46,5 <input type="checkbox"/> ~48 <input type="checkbox"/> ~49 5" <input type="checkbox"/> ~49 <input type="checkbox"/> ~50
U-TUBE Aluminium footplate Footplate distance (min 18 + max 35) DPmax = Front height - 10cm		
<b>HIGH FRAME 90°</b> Front height (min 47,5 - max 53) Footplate distance (min 36)	Casters 3" <input type="checkbox"/> ~48 <input type="checkbox"/> ~49 4" <input type="checkbox"/> ~49 <input type="checkbox"/> ~50 5" <input type="checkbox"/> ~51,5	Casters 3" <input type="checkbox"/> ~48,5 <input type="checkbox"/> ~50 4" <input type="checkbox"/> ~49,5 <input type="checkbox"/> ~51 <input type="checkbox"/> ~52 5" <input type="checkbox"/> ~52 <input type="checkbox"/> ~53
U-TUBE Aluminium footplate Footplate distance (min 21 + max 38) DPmax = Front height - 10cm		

The real front-seat height could be slightly different from the chosen one considering it is affected by seat depth and rear seat height.

### Rear height .....

- Rear wheels 22" (min 36 - max 44)
- Rear wheels 24" (min 38 - max 46)
- Rear wheels 25" (min 39 - max 47)
- Rear wheels 26" (min 41 - max 48)

The difference between Front Height and Rear Height must be in the 3 - 12 cm range.

Date ..... Order ..... User ..... Address .....

### Seat

- ☆ Seat cloth with pocket (under seat)
- Seat with tension straps 08883 **224,00**
- Carbon rigid seat 08336 **475,00**
- Pocket (under seat) [25x11x4,5] 08281 **74,00**

### CUSTOMIZE COLORS

- 1 Frame colour**
- Pearl white
  - Opaque black
  - Bright silver
  - Bright red
  - Bright blue
- Opaque orange 08341 **63,00**
- 2 Fork colour**
- ☆ Opaque black
  - Bright silver
  - Bright anthracite
  - Pearl white
  - Bright red
- 08342 **63,00**
- 3 Colour rear wheels**
- To be matched only with: Rear wheels Ultra-light Progeo - Standard! (22 - 24)
- ☆ Black
  - Bright silver
  - Bright anthracite (24")
  - Pearl white
  - Bright red
- 04692 **63,00**

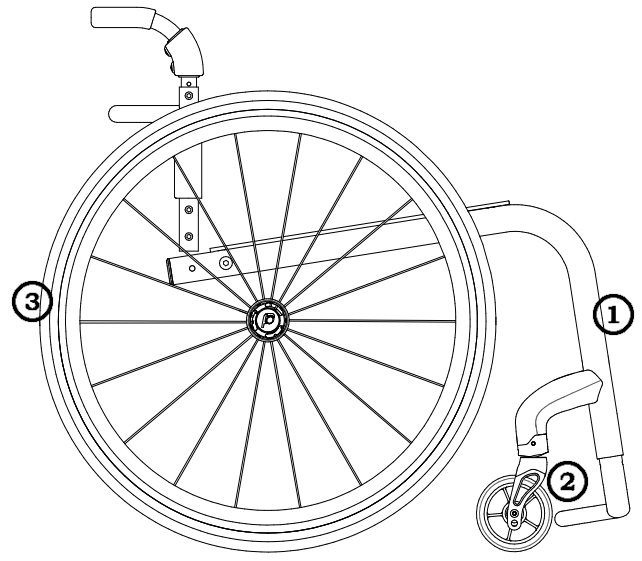

### Rear wheels axle

- ☆ Aluminum rear wheels axle
- Carbon fiber rear wheels axle (Lightest configuration) **07647 148,00**

### Backrest adjustment and fixing system

- ☆ Backrest with double locking (upright and folded) with rake adjustable from -4° to +16°
- Backrest with upright locking system ONLY (no locking when folded) with rake adjustable from -4° to +16°
- Fixed back(non-folding back) with rake adjustable from -4° to +16°

### Backrest

- ☆ Adjustable velcro straps and padded transpiring upholstery
- ☆ Aluminium backrest
- Titanium backrest 06811 **189,00**
- Carbon fibre backrest 04389 **749,00**

- AIR** Integrated posture backrest (NOT REMOVABLE) **1.047,00**
- Carbon shell - Lateral retaining 7,5cm  
Depth adjustment ±1cm. - Angle adjustment ±10°  
not available for seat width 48

H 28	H 34	H 40
Backrest Height (TS) min 34 ( ..... )	Backrest Height (TS) min 38 ( ..... )	Backrest Height (TS) min 44 ( ..... )
Lateral retaining wing A=high - R=regular		
A	R	A
R	A	R
R	R	A
A	A	R
<input type="checkbox"/>	<input type="checkbox"/>	<input type="checkbox"/>
<input type="checkbox"/>	<input type="checkbox"/>	<input type="checkbox"/>
<input type="checkbox"/>	<input type="checkbox"/>	<input type="checkbox"/>
<input type="checkbox"/>	<input type="checkbox"/>	<input type="checkbox"/>

### Installation on:

- ☆ Backrest tubes
- Aluminium backrest
- Titanium backrest 06811 **189,00**
- Carbon fibre backrest 04389 **749,00**



Date .....	Order .....	User .....	Address .....
------------	-------------	------------	---------------

<b>Handle tube</b>			
☆ Tubes with standard handle			
<input type="checkbox"/>	Tubes with short handle		
<input type="checkbox"/>	SPORT tubes Without push handles		
<input type="checkbox"/>	Carbon fibre tubes with short handle	Weight reduction approx. 110gr.	04390 148,00
<b>Not available with: Posture backrest PHYSIO - Posture backrest A I R</b>			
<input type="checkbox"/>	Folding handles		02958 252,00







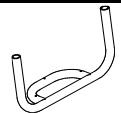
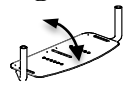

<b>Casters</b>			
☆ 4" Soft			
<input type="checkbox"/>	3" Sport		
<input type="checkbox"/>	5" Soft		
<input type="checkbox"/>	3" Active Soft (wide)	(Aluminium alloy rim)	06824 126,00
<input type="checkbox"/>	4" Active Sport (narrow)	(Aluminium alloy rim)	01398 126,00
<input type="checkbox"/>	4" Active Soft (wide)	(Aluminium alloy rim)	03943 126,00
<input type="checkbox"/>	5" Active Soft (wide)	(Aluminium alloy rim)	07518 126,00
<input type="checkbox"/>	5" Pneumatic		10844 63,00

<b>Rear wheels</b>			
☆ 24" Ultra-light Progeo - Standard!			
<input type="checkbox"/>	22" Ultra-light Progeo - Standard!		
<input type="checkbox"/>	25" Ultra-light Progeo - Standard!	(colour: black)	
<input type="checkbox"/>	26" Progeo - Standard!	(colour: black)	
<input type="checkbox"/>	24" ULTRA-LIGHT PROGEO KEY SPORT	Weight reduction approx. 450gr.	04383 876,00
<input type="checkbox"/>	24" Ultra-light "Spinergy LX"		01685 876,00
<input type="checkbox"/>	24" Ultra-light "Spinergy LXL"	<input type="checkbox"/> Black hub and white spokes <input type="checkbox"/> Hub and spokes black	07846 876,00
<input type="checkbox"/>	24" Ultra-light "Spinergy Flex rim"	<b>Integrated aluminium/rubber handrim</b>	02270 1.374,00
<input type="checkbox"/>	25" Ultra-light "Spinergy LX"		02101 876,00
<input type="checkbox"/>	25" Ultra-light "Spinergy LXL"	<input type="checkbox"/> Black hub and white spokes	07847 876,00
<input type="checkbox"/>	26" Ultra-light "Spinergy LX"		02102 876,00
<input type="checkbox"/>	24" Off-road (aluminium handrim black)		01392 224,00

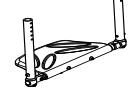
<b>Rear wheel tyre</b>			
<input type="checkbox"/>	High pressure tyre	(22"-24"-25"-26")	
<input type="checkbox"/>	High pressure profile tyre	(24")	
<input type="checkbox"/>	Marathon Plus	(24"-25")	with anti-puncture protection 01669 63,00
<input type="checkbox"/>	Anti-puncture - Colour Grey	(22")	04181 98,00
<input type="checkbox"/>	Anti-puncture - Colour Black	(24")	11083 126,00

<b>Handrim</b>		<b>Wheel distance</b> ☆ 3 cm <input type="checkbox"/> 4 cm	
<input type="checkbox"/>	Aluminium	(22"-24"-25"-26")	
<input type="checkbox"/>	Aluminium black SOFT-TOUCH	(24"-25")	(24" handrim, on 25" wheel is installed with spacers) 09170 126,00
<input type="checkbox"/>	Chromed Steel	(24"-25")	(24" handrim, on 25" wheel is installed with spacers) 01684 148,00
<input type="checkbox"/>	Titanium	(24"-25")	(24" handrim, on 25" wheel is installed with spacers) 00016 275,00
<input type="checkbox"/>	Ultra Grepp	(24"-25")	(24" handrim, on 25" wheel is installed with spacers) 00017 315,00
<input type="checkbox"/>	Max Grepp	(24"-25")	(24" handrim, on 25" wheel is installed with spacers) 00834 349,00
<input type="checkbox"/>	Ergo Para	(24")	00632 349,00
<input type="checkbox"/>	TOP FRICTION	(24"-25")	(24" handrim, on 25" wheel is installed with spacers) 11023 399,00
Oval countour with a rubber insert			
<input type="checkbox"/>	NOVA H	(24"-25")	(24" handrim, on 25" wheel is installed with spacers) 11025 263,00
Ergonomic black profile			
<input type="checkbox"/>	NOVA D	(24"-25")	(24" handrim, on 25" wheel is installed with spacers) 11026 286,00
Ergonomic profile with rubber coating (ideal for quadriplegics)			
<input type="checkbox"/>	SURGE LT	(25")	Oval countour with a rubber insert 06427 360,00
<input type="checkbox"/>	Quad (24")	(24")	00693 200,00
<input type="checkbox"/>	Silicon cover for standard aluminium handrim		Available for measures (22" - 24" - 26") 04050 160,00

<b>Wheel locks</b>			
☆ Bent lever push to lock			
<input type="checkbox"/>	Straight lever push to lock		
<input type="checkbox"/>	Straight lever pull to lock		
<input type="checkbox"/>	Sport brake		06428 126,00
<input type="checkbox"/>	Brake with extension lever push to lock		01949 63,00
<input type="checkbox"/>	Brake with extension lever pull to lock		03372 63,00



Date .....	Order .....	User .....	Address .....
<b>Footplate</b>			
☆ Aluminium footplate. Rake not adjustable			
☆ Aluminium footplate	<input type="checkbox"/> with plastic plate		
<input type="radio"/> One piece aluminium footplate - Flip-up! FLIP-BACK! - rake and depth adjustable			09420 189,00
<input type="radio"/> Aluminium footplate - rake and depth adjustable			04456 252,00
☆ Internal <input type="checkbox"/> 2/3 Internal <input type="checkbox"/> External <input type="checkbox"/> 2/3 External			
<input type="radio"/> U-TUBE - Aluminium footplate, rake and depth adjustable			09853 224,00
<b>LOW FRAME: minimum footplate distance 18 - maximum footplate distance 35</b>			
<b>HIGH FRAME: minimum footplate distance 21 - maximum footplate distance 38</b>			
<input type="radio"/> One piece Carbon fibre footplate. Rake adjustable			04110 372,00
☆ Internal <input type="checkbox"/> External			
<b>Armrests</b>			
<input type="radio"/> Tubular armrests	(Swing away, removable and height adjustable armrest)		00694 252,00
<input type="radio"/> Removable armrest with carbon-fiber straight sideguard	Available only with: Standard rear adjustment		09079 224,00
<b>Accessories</b>			
<input type="radio"/> Pad for front frame protectors			07058 52,00
<input type="radio"/> Backrest-seat connection cloth			10241 17,00
<input type="radio"/> Removable storage bag (with quick coupling)			09811 126,00
<b>Optional 1</b>			
<u>Only one optional devices for side can be chosen</u>			
<input type="radio"/> Transit wheels	Exclude the installation of Anti-tippers		03290 148,00
<input type="radio"/> Anti-tipper with rapid hookup	Exclude the installation of Transit wheels (inside rotation to reduce the encumbrance)		
	<input type="radio"/> Right		06821 126,00
	<input type="radio"/> Left		06822 126,00
<b>Optional 2</b>			
<input type="radio"/> Push handles for companion	(Removable and height adjustable)		03645 177,00
<input type="radio"/> Tetraclip	(Quick release axle for quadriplegic)		03947 177,00
<input type="radio"/> Safety pelvic belt			03972 63,00
<input type="radio"/> Harness			04103 126,00
<input type="radio"/> Lumbar support	(to insert in the backrest upholstery)		00013 40,00
<input type="radio"/> Swing away lateral support	<input type="radio"/> Right		02097 252,00
	<input type="radio"/> Left		02098 252,00
<b>Not available with: Posture backrest PHYSIO - Posture backrest A I R</b>			
<input type="radio"/> Spoke guards Black	(22"-24")		01043 148,00
<input type="radio"/> Spoke guards Transparent	(22"-24")		00835 148,00
<input type="radio"/> Spoke guards Progeo design	(22"-24")		00019 177,00
<input type="radio"/> Spoke guards Dragon	(22"-24")		02106 177,00
<b>Additional Kit</b>			
<input type="radio"/> 24" Off-road rear wheels	Off-Road tyre - aluminium handrim (black colour)		03378 498,00
<input type="radio"/> 24" FAT rear wheels	FAT tyre 3" - aluminium handrim (black colour)		09357 876,00

Date ..... Order ..... User ..... Address .....

### PHYSIO - Posture backrest (Std. Backrest upholstery not provided)

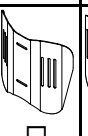
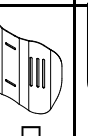

Removable with quick release  
Suitable for tubes with diameter 18+26mm  
Depth adjustment (4cm)  
Angle adjustment ( $\pm 18^\circ$ )

- AIR** Carbon shell  
not available for seat width 48

BACKREST HEIGHT	28	34	40	
Shell's shape 	Lateral retaining wing A=high - R=regular			
				
	<input type="checkbox"/>	<input type="checkbox"/>	<input type="checkbox"/>	<input type="checkbox"/>

1.047,00

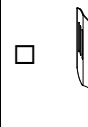
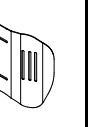
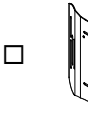
- POSTURE** Aluminum shell

BACKREST HEIGHT	34	40	52	
Shell's shape 	Lateral retaining wing B=regular			
				
	<input type="checkbox"/>	<input type="checkbox"/>	<input type="checkbox"/>	<input type="checkbox"/>

1.013,00

### Configuration DEEP with side support PAD (height adjustable)

- Alluminum lateral with padded, breathable upholstery.



Small (h 13cm)



Right  
10272

29,00

Left  
10272

Large (h 20cm)



Right  
10273

40,00

Left  
10273

40,00

### SWING AWAY - Lateral support

Fixing and adjustment hardware complete with protection sleeve  
Alluminum lateral with padded, breathable upholstery.

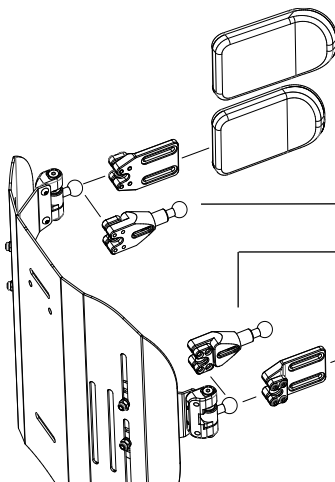

Large (18x12)

05647 183,00

Small (14x9)

05643 183,00

Lateral support extension

Quantity (number pcs).....

10271 69,00

Lateral support extension

Quantity (number pcs).....

Small (14x9)

05642 183,00

Large (18x12)

05646 183,00

- Headrest adjustable - Double ball mounting system



Available only with backrest Physio  
Not available for backrest Physio AIR carbon shell

Large (34x14)  
 Small (28x14)

05648 252,00

Date .....	Order .....	User .....	Address .....
------------	-------------	------------	---------------

--

--

--

<b>Note</b>

Wheelchair : Progeo JOKER R2 - Rev. 2023.2	Prices - VAT excluded to be added to the price list	<b>Send this page only if any optional have been chosen</b>
		<input type="checkbox"/> <b>standard</b> (supplied if no requests are indicated)
		<input type="checkbox"/> <b>on request</b> (without extra charge)
		<input type="checkbox"/> <b>optional</b> (cost to be added at the basic price)