

permobil Order Form - Progeo JOKER



Permobil Limited Unit 7, Polaris Centre, 41 Brownfields, Welwyn Garden City, Herts, AL7 1AN United Kingdom - Phone: +44 1484 722888



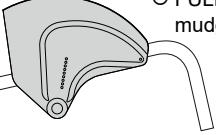

Date	UK (English)	
User	Company stamp	Rigid frame wheelchair CRASH TEST APPROVED
End user weight (kg)		£ 2592,00
Language user manual	Responsible	Retail price - VAT not included

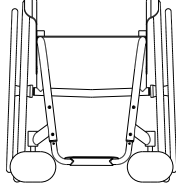
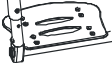
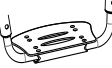
Wheelchair measures							
Seat width (LS)	<input type="checkbox"/> 33	<input type="checkbox"/> 36	<input type="checkbox"/> 39	<input type="checkbox"/> 42	<input type="checkbox"/> 45	<input type="checkbox"/> 48	
Seat depth (PS)	<input type="checkbox"/> 35	<input type="checkbox"/> 37,5	<input type="checkbox"/> 40	<input type="checkbox"/> 42,5	<input type="checkbox"/> 45	<input type="checkbox"/> 47,5	<input type="checkbox"/> 50
The real seat depth, from the front part of the seat cloth to the backrest tube will be 1,5 cm more than the declared one.							
Footplate distance (DP) (cm) ±0.5cm - adjustment steps 1.5cm						
(Real distance between seat and footplate) - IMPORTANT NOTICE! From the footplate to the floor minimum 4cm !! (Minimum Front height = DP + 4cm.)							
Setting	★ Standard		<input type="checkbox"/> Prudential	<input type="checkbox"/> Active	<input type="checkbox"/> Extreme		
Backrest Height (TS)	Std. Value 33,5(min 24.5-max 47) adjustment steps 1.5cm						
camber	★ 0°		<input type="checkbox"/> 2°	<input type="checkbox"/> 4°			
Front height STD 49			Rear height STD 42		

	★ Alluminum rear adjustment plate ★ Removable mudguard ABS <input type="checkbox"/> Removable ABS fibre straight sideguard <input type="radio"/> Removable carbon fibre mudguard <input type="radio"/> Removable Carbon fibre straight sideguard			
		03946	315,00	
		08918	315,00	

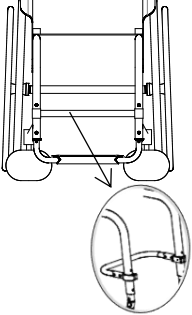
	<input type="radio"/> FULL CARBON rear adjustment plate with integrated mudguard ★ Version mudguard (Available only with rear wheels 24") <input type="checkbox"/> Version straight sideguard			
		07646	939,00	

JOKER		<input type="checkbox"/> Aluminium footplate, rake adjustable Minimum footplate distance 35cm. ★ Internal <input type="checkbox"/> 2/3 Internal <input type="checkbox"/> External <input type="checkbox"/> 2/3 External		11523	no list
		<input type="radio"/> Aluminium footplate EVOLUTION - rake and depth adjustable Minimum footplate distance 35cm. ★ Internal <input type="checkbox"/> 2/3 Internal <input type="checkbox"/> External <input type="checkbox"/> 2/3 External		07649	126,00
		<input type="radio"/> One piece Carbon fibre footplate JOKER Minimum footplate distance 35cm. not available for seat width 48		03348	252,00
		<input type="radio"/> One piece Carbon fibre footplate, rake adjustable Minimum footplate distance 35cm. ★ Internal <input type="checkbox"/> External		03346	298,00

JOKER ZERO		<input type="radio"/> Plastic footrest, rake adjustable Minimum footplate distance 15cm. ★ 2/3 Internal <input type="checkbox"/> 2/3 External		06814	189,00
		<input type="radio"/> One piece aluminium footplate - Flip-up!, rake and depth adjustable Minimum footplate distance 15cm. ★ Internal <input type="checkbox"/> 2/3 Internal <input type="checkbox"/> External <input type="checkbox"/> 2/3 External		06856	189,00
		<input type="radio"/> One piece Carbon fibre footplate rake adjustable, swing away, flip-up. Minimum footplate distance 15cm. ★ Internal <input type="checkbox"/> External		06857	487,00

customer_support_uk@permobil.com - https://www.permobil.com/en-gb

Date Order User Address

Front frame

☆ Aluminium standard frame

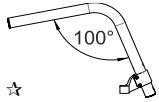

☆

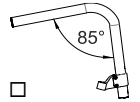
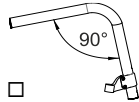

(max 4" caster)

Colour aluminium frame

☆ Bright silver

- Polished black
- Opaque black

- Bright blue
- Bright anthracite

- Bright orange
- Bright fuchsia
- Bright red

- Bright lime
- Bright blue china
- Pearl white

Seat

☆ Seat cloth with pocket (under seat)

Seat with tension straps

08883 224,00

Carbon rigid seat

08336 475,00

Pocket (under seat) [25x11x4,5]

08281 74,00

Rear wheels axle

☆ Aluminum rear wheels axle

Carbon fiber rear wheels axle

(Lightest configuration)

07647 148,00

Backrest adjustment and fixing system

☆ Backrest with double locking (upright and folded)
with rake adjustable from -4° to +16°

Backrest with upright locking system ONLY (no locking when folded)
with rake adjustable from -4° to +16°

Fixed back(non-folding back)
with rake adjustable from -4° to +16°

Backrest

☆ Adjustable velcro straps and padded transpiring upholstery

☆ Aluminium backrest



Titanium backrest

06811 189,00

Carbon fibre backrest

04389 749,00



AIR Integrated posture backrest (NOT REMOVABLE)

Carbon shell - Lateral retaining 7,5cm
Depth adjustment ±1cm. - Angle adjustment ±10°
not available for seat width 48

1.047,00

Installation on:

☆ Backrest tubes



Aluminium backrest



Titanium backrest

06811 189,00

Carbon fibre backrest

04389 749,00



H 28		H 34		H 40	
Backrest Height (TS) min 34		Backrest Height (TS) min 38		Backrest Height (TS) min 44	
(.....)		(.....)		(.....)	
Lateral retaining wing A=high - R=regular					
A	R	A	R	A	R
<input type="checkbox"/>	<input type="checkbox"/>	<input type="checkbox"/>	<input type="checkbox"/>	<input type="checkbox"/>	<input type="checkbox"/>

Date	Order	User	Address
------------	-------------	------------	---------------

Handle tube			
☆ Tubes with standard handle			
<input type="checkbox"/>	Tubes with short handle		
<input type="checkbox"/>	SPORT tubes Without push handles		
<input type="radio"/>	Carbon fibre tubes with short handle	(Lightest configuration)	04390 148,00
Not available with: Posture backrest PHYSIO - Posture backrest A I R			
<input type="radio"/>	Folding handles		02958 252,00







Casters			
☆ 4" Soft			
<input type="checkbox"/>	3" Sport	(Lightest configuration)	
<input type="checkbox"/>	5" Soft		
<input type="checkbox"/>	6" Soft	(Available only with 100° angle)	
<input type="checkbox"/>	6" Pneumatic	(Available only with 100° angle)	
<input type="radio"/>	3" Active Soft (wide)	(Aluminium alloy rim)	06824 126,00
<input type="radio"/>	4" Active Sport (narrow)	(Aluminium alloy rim)	01398 126,00
<input type="radio"/>	4" Active Soft (wide)	(Aluminium alloy rim)	03943 126,00
<input type="radio"/>	5" Active Soft (wide)	(Aluminium alloy rim)	07518 126,00
<input type="radio"/>	5" Pneumatic		10844 63,00

Colour set: Rear wheels and forks - To be matched only with: Rear wheels Ultra-light Progeo - Standard! (22 - 24)			
☆ Black	22" 24" 25" 26"		
<input type="radio"/>	Bright silver	22" 24"	00833 126,00
<input type="radio"/>	Bright anthracite	24"	00833 126,00
<input type="radio"/>	Bright orange	22" 24"	00833 126,00
<input type="radio"/>	Bright fuchsia	22" 24"	00833 126,00
<input type="radio"/>	Bright blue	22" 24"	00833 126,00
<input type="radio"/>	Bright red	22" 24"	00833 126,00
<input type="radio"/>	Bright lime	22" 24"	00833 126,00
<input type="radio"/>	Pearl white	22" 24"	00833 126,00

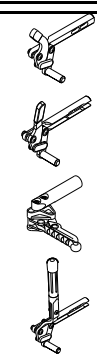
Rear wheels			
☆ 24" Ultra-light Progeo - Standard!			
<input type="checkbox"/>	22" Ultra-light Progeo - Standard!		
<input type="checkbox"/>	25" Ultra-light Progeo - Standard!	(colour: black)	
<input type="checkbox"/>	26" Progeo - Standard!	(colour: black)	
<input type="radio"/>	24" ULTRA-LIGHT PROGEO KEY SPORT	Weight reduction approx. 450gr.	04383 876,00
<input type="radio"/>	24" Ultra-light "Spinergy LX"		01685 876,00
<input type="radio"/>	24" Ultra-light "Spinergy LXL"	<input type="checkbox"/> Black hub and white spokes <input type="checkbox"/> Hub and spokes black	07846 876,00
<input type="radio"/>	24" Ultra-light "Spinergy Flex rim"	Integrated aluminium/rubber handrim	02270 1.374,00
<input type="radio"/>	25" Ultra-light "Spinergy LX"		02101 876,00
<input type="radio"/>	25" Ultra-light "Spinergy LXL"	<input type="checkbox"/> Black hub and white spokes	07847 876,00
<input type="radio"/>	26" Ultra-light "Spinergy LX"		02102 876,00
<input type="radio"/>	24" Off-road (aluminium handrim black)		01392 224,00

Rear wheel tyre			
☆ High pressure tyre	(22"-24"-25"-26")	(Lightest configuration)	
<input type="checkbox"/>	High pressure profile tyre	(24")	
<input type="radio"/>	Marathon Plus	(24"-25") with anti-puncture protection	01669 63,00
<input type="radio"/>	Anti-puncture - Colour Grey	(22")	04181 98,00
<input type="radio"/>	Anti-puncture - Colour Black	(24")	11083 126,00

Handrim		Wheel distance ☆ 3 cm	<input type="checkbox"/> 4 cm	
☆ Aluminium		(22"-24"-25"-26")	(Lightest configuration)	
<input type="radio"/>	Aluminium black SOFT-TOUCH	(24"-25")	(24" handrim, on 25" wheel is installed with spacers)	09170 126,00
<input type="radio"/>	Chromed Steel	(24"-25")	(24" handrim, on 25" wheel is installed with spacers)	01684 148,00
<input type="radio"/>	Titanium	(24"-25")	(24" handrim, on 25" wheel is installed with spacers)	00016 275,00
<input type="radio"/>	Ultra Grepp	(24"-25")	(24" handrim, on 25" wheel is installed with spacers)	00017 315,00
<input type="radio"/>	Max Grepp	(24"-25")	(24" handrim, on 25" wheel is installed with spacers)	00834 349,00
<input type="radio"/>	Ergo Para	(24")		00632 349,00
<input type="radio"/>	TOP FRICTION	(24"-25")	(24" handrim, on 25" wheel is installed with spacers)	11023 399,00
Oval countour with a rubber insert				
<input type="radio"/>	NOVA H	(24"-25")	(24" handrim, on 25" wheel is installed with spacers)	11025 263,00
Ergonomic black profile				
<input type="radio"/>	NOVA D	(24"-25")	(24" handrim, on 25" wheel is installed with spacers)	11026 286,00
Ergonomic profile with rubber coating (ideal for quadriplegics)				
<input type="radio"/>	SURGE LT	(25")	Oval countour with a rubber insert	06427 360,00
<input type="radio"/>	Quad (24")	(24")		00693 200,00
<input type="radio"/>	Silicon cover for standard aluminium handrim		Available for measures (22" - 24" - 26")	04050 160,00





Date	Order	User	Address
Wheel locks			
<input checked="" type="checkbox"/> Bent lever push to lock <input type="checkbox"/> Straight lever push to lock <input type="checkbox"/> Straight lever pull to lock <input type="checkbox"/> Sport brake (Lightest configuration) <input type="checkbox"/> Brake with extension lever push to lock <input type="checkbox"/> Brake with extension lever pull to lock			06428 126,00 01949 63,00 03372 63,00
Armrests			
<input type="checkbox"/> Tubular armrests (Swing away, removable and height adjustable armrest)			00694 252,00
Accessories			
<input type="checkbox"/> Pad for front frame protectors <input type="checkbox"/> Backrest-seat connection cloth <input type="checkbox"/> Removable storage bag (with quick coupling)			07058 52,00 10241 17,00 09811 126,00
SAFETY			
<input type="checkbox"/> 4 points tie-down system rings			08654 189,00
Optional 1			
<u>Only one optional devices for side can be chosen</u>			
<input type="checkbox"/> Transit wheels Exclude the installation of Anti-tippers			03290 148,00
<input type="checkbox"/> Anti-tipper BASE Exclude the installation of Transit wheels <input type="checkbox"/> Right <input type="checkbox"/> Left			06819 98,00 06820 98,00
<input type="checkbox"/> Anti-tipper with rapid hookup (inside rotation to reduce the encumbrance) Exclude the installation of Transit wheels <input type="checkbox"/> Right <input type="checkbox"/> Left			06821 126,00 06822 126,00
Optional 2			
<input type="checkbox"/> Push handles for companion (Removable and height adjustable)			03645 177,00
<input type="checkbox"/> Tetraclip (Quick release axle for quadriplegic)			03947 177,00
<input type="checkbox"/> Safety pelvic belt <input type="checkbox"/> Harness			03972 63,00 04103 126,00
<input type="checkbox"/> Lumbar support (to insert in the backrest upholstery)			00013 40,00
<input type="checkbox"/> Swing away lateral support Not available with Posture backrest PHYSIO - Posture backrest A I R <input type="checkbox"/> Right <input type="checkbox"/> Left			02097 252,00 02098 252,00
<input type="checkbox"/> Spoke guards Black (22"-24") <input type="checkbox"/> Spoke guards Transparent (22"-24") <input type="checkbox"/> Spoke guards Progeo design (22"-24") <input type="checkbox"/> Spoke guards Dragon (22"-24")			01043 148,00 00835 148,00 00019 177,00 02106 177,00
Additional Kit			
<input type="checkbox"/> 24" Off-road rear wheels Off-Road tyre - aluminium handrim (black colour)			03378 498,00
<input type="checkbox"/> 24" FAT rear wheels FAT tyre 3" - aluminium handrim (black colour)			09357 876,00

Date Order User Address

PHYSIO - Posture backrest (Std. Backrest upholstery not provided)

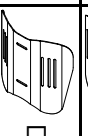
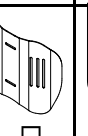

Removable with quick release
Suitable for tubes with diameter 18÷26mm
Depth adjustment (4cm)
Angle adjustment (±18°)

- AIR** Carbon shell
not available for seat width 48

BACKREST HEIGHT	28	34	40		
Shell's shape 	Lateral retaining wing A=high - R=regular				
					
	<input type="checkbox"/>	<input type="checkbox"/>	<input type="checkbox"/>	<input type="checkbox"/>	<input type="checkbox"/>

1.047,00

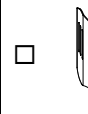
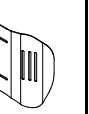
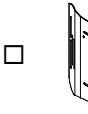
- POSTURE** Aluminum shell

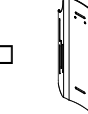
BACKREST HEIGHT	34	40	52		
Shell's shape 	Lateral retaining wing B=regular				
					
	<input type="checkbox"/>	<input type="checkbox"/>	<input type="checkbox"/>	<input type="checkbox"/>	<input type="checkbox"/>

1.013,00

Configuration DEEP with side support PAD (height adjustable)

- Alluminum lateral with padded, breathable upholstery.



Small (h 13cm)



Right
10272

29,00

Left
10272

29,00

Large (h 20cm)



Right
10273

40,00

Left
10273

40,00

SWING AWAY - Lateral support

Fixing and adjustment hardware complete with protection sleeve
Alluminum lateral with padded, breathable upholstery.

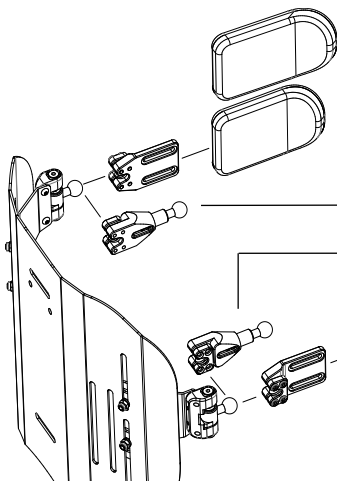

- Large (18x12)

05647 183,00

- Small (14x9)

05643 183,00

- Lateral support extension

Quantity (number pcs) (.....)

10271 69,00

- Lateral support extension

Quantity (number pcs) (.....)

- Small (14x9)

05642 183,00

- Large (18x12)

05646 183,00

- Headrest adjustable - Double ball mounting system

Available only with backrest Physio
Not available for backrest Physio AIR carbon shell



- Large (34x14)
- Small (28x14)



05648 252,00

Date	Order	User	Address
------------	-------------	------------	---------------

Note

Wheelchair : Progeo JOKER - Rev. 2023.1	Prices - VAT excluded <small>to be added to the price list</small>	<table border="1" style="width: 100%; border-collapse: collapse;"> <tr> <td colspan="2" style="text-align: center; padding: 2px;">Send this page only if any optional have been chosen</td> </tr> <tr> <td style="padding: 2px;"><input type="checkbox"/> standard</td> <td style="padding: 2px;"><small>(supplied if no requests are indicated)</small></td> </tr> <tr> <td style="padding: 2px;"><input type="checkbox"/> on request</td> <td style="padding: 2px;"><small>(without extra charge)</small></td> </tr> <tr> <td style="padding: 2px;"><input type="checkbox"/> optional</td> <td style="padding: 2px;"><small>(cost to be added at the basic price)</small></td> </tr> </table>	Send this page only if any optional have been chosen		<input type="checkbox"/> standard	<small>(supplied if no requests are indicated)</small>	<input type="checkbox"/> on request	<small>(without extra charge)</small>	<input type="checkbox"/> optional	<small>(cost to be added at the basic price)</small>
Send this page only if any optional have been chosen										
<input type="checkbox"/> standard	<small>(supplied if no requests are indicated)</small>									
<input type="checkbox"/> on request	<small>(without extra charge)</small>									
<input type="checkbox"/> optional	<small>(cost to be added at the basic price)</small>									

REFERENCE TABLES

1		Front height			
With closed frame (95°) max 5" caster With closed frame (90°) max 5" caster With closed frame (85°) max 4" caster					
FORK		Casters			
		3"	4"	5"	6"
SPORT		max 52	max 53	max 54	
SMALL		max 54	max 55	max 56	max 57
MEDIUM		max 56	max 57	max 58	max 59
The size of the fork will be defined only by Progeo in accordance with wheelchair final configuration.					

2		Rear height			
Rear wheels					
		22"	24"	25"	26"
min	36	min	38	min	39
max	44	min	46	max	47
		min	48	max	48

3	Footplate option	Footplate distance
	Aluminium footplate rake adjustable	min 35
	One piece Carbon fibre footplate	min 35
	One piece Carbon fibre footplate rake adjustable	min 35
	Plastic footrest, rake adjustable	min 35
	One piece aluminium footplate - Flip-up!, rake and depth adjustable	min 35
	One piece Carbon fibre footplate rake adjustable, swing away, flip-up.	min 35
IMPORTANT NOTICE! From the footplate to the floor minimum 4cm !! (Minimum Front height = DP + 4cm.)		
Calculated with the best configuration and with the footplates positioned on inside.		
NOTE! Lower footplate distances are possible only after our valuation		

4	Rear wheels	
	Model	Features
	22" Ultra-light Progeo - Standard!	(not available in anthracite color)
	24" Ultra-light Progeo - Standard!	(available for all colors)
	24" ULTRA-LIGHT PROGEO KEY SPORT	(silver hub, black rim and 16 spokes)
	24" Ultra-light "Spinergy LX"	(silver hub, black rim and spokes)
	24" Ultra-light "Spinergy LXL"	(black hub and rim, 18 white spokes) - (black hub, rim and 18 spokes)
	24" Ultra-light "Spinergy Flex rim"	(silver hub, black rim and spokes) - (integrated aluminium/rubber handrim - encumbrance reduction up to 3cm. - all tyre)
	24" Off-road	(colour: black) - (aluminium handrim - tyre Off-road)
	25" Ultra-light "Spinergy LX"	(silver hub, black rim and spokes)
	25" Ultra-light "Spinergy LXL"	(black hub and rim, 18 white spokes)
	26" Progeo - Standard!	(colour: black)
	26" Ultra-light "Spinergy LX"	(silver hub, black rim and 18 spokes)

Wheelchair : Progeo JOKER - Rev. 2023.1