



Lightweight activity wheelchair with rigid frame, for children (already from 12 months)

Included in the base price

- Frame versions Retro or Taurus
- 2 different V-shaped abductions for maximized leg space
- growable without additional parts in seat width (2 cm), seat depth (max. 4 cm) and back height (5 cm)
- adjustable back angle (80°-100°)
- Activity side guards with integrated bowden cable brake. Also included
- seat plate; stabilizer bar; Standard- Profile- or Light-weight wheels; Caster wheels with aluminum fork; wheel cover

Quotation Order

Weight capacity: 50 kg
German aid index N°: 18.50.03.2006

Base price £2,645

Prices excl. VAT, valid from 01.03.2021

Delivery address / Company stamp:		Billing address: <input type="checkbox"/> same as delivery address	
Name:		Name:	
Address:		Address:	
Ordering information:			
Reference/ internal description:		Date:	
Contact person:		Signature:	

Frame measures				cf. example on p.4
Seat width 10..	Seat depth 11..	Back height 12..	Seat height front in cm	Lower leg length
+ 2 cm extension each <input type="checkbox"/> 18 <input type="checkbox"/> 20 <input type="checkbox"/> 22 <input type="checkbox"/> 24 <input type="checkbox"/> 26 <input type="checkbox"/> 28 <input type="checkbox"/> 30 <input type="checkbox"/> 32 <input type="checkbox"/> 34 	+ 4 cm extension each <input type="checkbox"/> 18 <input type="checkbox"/> 20 <input type="checkbox"/> 22 <input type="checkbox"/> 24 <input type="checkbox"/> 26 <input type="checkbox"/> 28 <input type="checkbox"/> 30 <input type="checkbox"/> 32 <input type="checkbox"/> 34 <input type="checkbox"/> 36 	The back height can be chosen when selecting the back system see on page 3 	At wheel size 18" <input type="checkbox"/> 31,5 <input type="checkbox"/> 33 <input type="checkbox"/> 34,5 <input type="checkbox"/> 36 At wheel size 20" <input type="checkbox"/> 34 <input type="checkbox"/> 35,5 <input type="checkbox"/> 37 <input type="checkbox"/> 38,5 <input type="checkbox"/> 40 At wheel size 22" <input type="checkbox"/> 36 <input type="checkbox"/> 37,5 <input type="checkbox"/> 39 <input type="checkbox"/> 40,5 <input type="checkbox"/> 42 At wheel size 24" <input type="checkbox"/> 38,5 <input type="checkbox"/> 40 <input type="checkbox"/> 41,5 <input type="checkbox"/> 43 <input type="checkbox"/> 44,5 cf. table on page 13	1. Real lower leg length of the user (LLL): _____ cm 2. Cushion thickness (CT) _____ cm



Frame versions				Retro-Frame	Taurus-Frame
Retro-Frame N° 597301 recommended for LLL 15 cm-30 cm* <input type="checkbox"/> Strong abduction casters on one line with rear wheels N° 597305 £ 0		Taurus-Frame N° 597304 recommended for LLL 20 cm-37 cm* <input type="checkbox"/> Slight abduction casters narrower than rear wheels N° 597306 £ 0		<input type="checkbox"/> Strong abduction casters on one line with rear wheels N° 597305 £ 0	<input type="checkbox"/> Slight abduction casters narrower than rear wheels N° 597306 £ 0

*For other configurations please contact us!

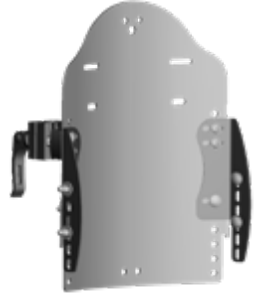
Colours		
Finish alternatives <input type="checkbox"/> Shiny £ 0 <input type="checkbox"/> Matt Not possible with special colours! N° 1561 £75	Moderate metallic effect (except for Black & King's Blue) <input type="checkbox"/> Zinc Yellow (02) <input type="checkbox"/> Dark Green (15) <input type="checkbox"/> Pure Orange (21) <input type="checkbox"/> Crimson (04) <input type="checkbox"/> Pastel Blue (20) <input type="checkbox"/> Dark Blue (16) <input type="checkbox"/> Brilliant Blue (08) <input type="checkbox"/> Cream White (17) not metallic: <input type="checkbox"/> Girly Pink (19) <input type="checkbox"/> Black (31) <input type="checkbox"/> Chrome Yellow (06) <input type="checkbox"/> King's Blue (32)	Special colours (without additional charge, except for Nightblue) Strong metallic effect: Silver Metallic (36) Anthracite Metallic (22) Dormant colours: Apple Green Dormant (18) Fire Red Dormant (45) Violet Dormant (50) Coarse structured surface: Dormant col. with additional charge: Coarse Black (27) Nightblue Dorm. (47) œ)
Design package color anodization (Colour examples for anodized colours can be found on our website in the area equipment)		
<input type="checkbox"/> anodized Blue (01) <input type="checkbox"/> anodized Red (02) <input type="checkbox"/> anodized Green (03) <input type="checkbox"/> anodized Gold Orange (04) <input type="checkbox"/> anodized Violet (05) N° 1569.. £195	The following parts are anodized: Caster forks, hand rims, brake bar and push handle bar The design package ist only possible in the listed setting.	Restrictions: The hand rims are only available in the design package anodized colours by choosing aluminum hand rims. (Not possible with stainless steel, Maxgrepp, PVC, double or nob hand rims. Also not possible with profile wheels).

Back system WITHOUT back tubes			
Weight advantage - Since the curved back plate is directly mounted on the side guards, no back tubes are needed.			
Back height 12..	Curved back plate model „Mio 1“	Curved back plate model „Mio 3“	Back extension
Please choose here the back height for this back system growing 2,5 cm each <input type="checkbox"/> 17,5 <input type="checkbox"/> 20 <input type="checkbox"/> 22,5 <input type="checkbox"/> 25 <input type="checkbox"/> 27,5 <input type="checkbox"/> 30 <input type="checkbox"/> 32,5 <input type="checkbox"/> 35	Curved back plate made of aluminium, BH + 2 cm; <input type="checkbox"/> 20-30 mm curve depth, growable!	Curved back plate made of aluminium, BH + 5 cm; <input type="checkbox"/> 20-30 mm curve depth, growable!	<input type="checkbox"/> extension up to 17.5 cm, retractable, with detachable head cushion; Weight advantage compared to a standard headrest up to 1000 g from SW 22 cm, not possible with head rest (N° 6860..) and back foil N° 2527) not suitable as a head rest for the transport in a passenger vehicle Restrictions in combination with curved back plate: Curved back plate Mio 1: from back height 35 cm Curved back plate Mio 3: from back height 30 cm
Back angle adjustable SCREWED <input type="checkbox"/> Adjustable from 80°-100° (in 5° steps), by screwing Standard configuration: 90° Desired back angle: <input type="checkbox"/> ____°			
N° 697800 £ 0	N° 697801 £ 0	N° 697802 £165	N° 686069 £265

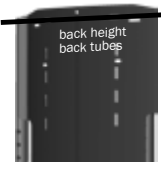
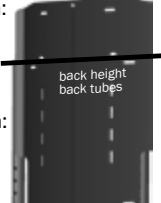
or

Back system WITH back tubes			
Back height 12..	Adjustable back cover	Curved back plate	WITHOUT cover / curved back plate
Please choose here the back height for this back system growing 5 cm each <input type="checkbox"/> 25 <input type="checkbox"/> 30 <input type="checkbox"/> 35 <input type="checkbox"/> 40	<input type="checkbox"/> Adjustable cover with strap system, incl. back cushion (thickness 2 cm), please choose your breathable cover colour on page 4. Possible from SW 24.	Model 1 BH+2 cm; curve depth: <input type="checkbox"/> 15 mm (..015) <input type="checkbox"/> 30 mm (..030) <input type="checkbox"/> 50 mm (..050) Model 2 BH+10 cm; curve depth: <input type="checkbox"/> 15 mm (..115) <input type="checkbox"/> 30 mm (..130) <input type="checkbox"/> 50 mm (..150) BH+20 cm; curve depth: <input type="checkbox"/> 15 mm (..215) <input type="checkbox"/> 30 mm (..230) <input type="checkbox"/> 50 mm (..250) Model 3 BH+5 cm; curve depth: <input type="checkbox"/> 15 mm (..315) <input type="checkbox"/> 30 mm (..330) <input type="checkbox"/> 50 mm (..350) BH+10 cm; curve depth: <input type="checkbox"/> 15 mm (..415) <input type="checkbox"/> 30 mm (..430) <input type="checkbox"/> 50 mm (..450) Attention: curve depth 50mm only from seat width 30cm	<input type="checkbox"/> WITHOUT back cover or curved back plate Please choose this option if you need only back tubes Please note: The selection of the adjustable back angle is necessary. Choose SCREWED (N° 697800) or RASTER (N° 627801).
Back angle adjustable SCREWED <input type="checkbox"/> Adjustable from 80°-100° (in 5° steps), by screwing Standard configuration: 90° incl. stabilizer bar Desired back angle: <input type="checkbox"/> ____°		  	<input type="checkbox"/> WITHOUT back cover or curved back plate Please choose this option if you need only back tubes Please note: The selection of the adjustable back angle is necessary. Choose SCREWED (N° 697800) or RASTER (N° 627801).
N° 697805 £ 0	N° 6701.. £199	N° 698... £166	N° 670399 £ 0
Back angle adjustable RASTER <input type="checkbox"/> Adjustable in angle by raster from 78°, 90°, 102° or 114°, folds down forward, incl. stabilizer bar			Back extension for curved back plate <input type="checkbox"/> extension up to 17.5 cm, retractable, with detachable head cushion; Weight advantage compared to a standard headrest up to 1000 g Fom SW 22 cm, not possible with head rest (N° 6860..) and back foil N° 2527) Not suitable as a head rest for the transport in a passenger vehicle Restrictions in combination with curved back plate: Curved back plate 1: from back height 35 cm Curved back plate 2: Not possible Curved back plate 3: from back height 30 cm, only with version BH+5 cm
N° 627801 £270			N° 686069 £260

Adaptation holder for Tarta® back system	
Please choose: <input type="checkbox"/> for back angle adjustable SCREWED incl. Tarta back tubes <input type="checkbox"/> for back angle adjustable RASTER incl. Tarta back tubes	Mounting possible from SW26. Order information for Tarta back system and instructions at www.ebecoreha.de Not permitted when using the wheelchair as a seat for transportation in the car! Tarta back is NOT included! Only possible with N° 697805 (back angle SCREWED) or N° 697801 (back angle RASTER)
N° 611705 £189	

To see the latest versions of our order forms, please visit www.sorgrollstuhltechnik.de/download-portal



Back extension	
Extended	Retracted
Back extended	Retracted back extension (back view)

Push handles		
Standard	Single-hand push handle	Bow handle
Extendable 	Foldable Item only available until December 31, 2021.	angle and height adjustable, with synthetic or metal hinge (depending on the seat width)

Measuring the lower leg length			
Manufacturer data	User data	Retailer data	
Our data for the possible lower leg length are: The maximum or rather minimal possible distance between the top edge of the seat to the top edge of the foot plate MEASURED VERTICALLY (90°) .	You are measuring at the user: The distance between the hollow of the knee to the floor (=LLL) , measured at a vertical leg position of 90°	When ordering, please indicate TWO measures: <ul style="list-style-type: none"> • 1. the real LLL of the user AND • 2. the thickness of the cushion used by you 	

Example		
Our data	Your data	We are assembling
In the order form, we are indicating e.g.: „possible distance from top edge seat to top edge foot plate at internal mounting of leg support = min. 3.5 up to max. 30 cm“.	The real lower leg length of the user amounts e.g.: „LLL = 31 cm“ ; The thickness of the cushion used by you amounts e.g.: „CT = 5 cm“.	Using your data, our technicians are calculating a distance of 26 cm between the top edge of the seat to the top edge of the foot plate. Therefore, the foot plate will be mounted to the position of 26 cm, measured vertically. <i>At a cushion thickness of only 3 cm, our technicians would mount the foot plate to a distance of 28 cm from the top edge of the seat to the top edge of the footplate instead.</i>

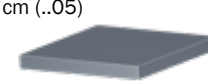
To see the latest versions of our order forms, please visit www.sorgrollstuhltechnik.de/download-portal

Seat cushion (all covers with zippers and changeable)				
	Standard cushion	Anatomical cushion	Cover design	Incontinence cover
<input type="checkbox"/> No seat cushion (please tick if no cushion is required)	Synthetic foam for firm and comfortable seating <input type="checkbox"/> 3 cm (..03) <input type="checkbox"/> 5 cm (..05) 	<input type="checkbox"/> Anatomically formed, with slight abduction, changeable cover (Thickness of the front upholstery, depending on cushion size, is 5-6 cm) 	The colour of the chosen covers can be selected below. -> choice of cover colour	<input type="checkbox"/> For standard cushion as chosen on the left
	N° 80.. £90	N° 891002 £419	N° 80.. £ 0	N° 86.. £89
Additional covers for cushions as chosen on the right <input type="checkbox"/> 1 cover (..01) <input type="checkbox"/> 2 covers (..02)	Relax cushion for medium-soft seating <input type="checkbox"/> 3 cm (..03) <input type="checkbox"/> 5 cm (..05)	<input type="checkbox"/> Additional cover for anatomical cushion as chosen on the right	<input type="checkbox"/> Seat cushion as chosen, without cover	<input type="checkbox"/> For anatomical cushion as chosen on the left
N° 82.. £75	N° 81.. £119	N° 891003 £166	N° 998001 £30	N° 891004 £166

Seat system	Back cushions (all covers with zippers and changeable)			
Alu seat plate	Standard cushion	Anat. back cushion	Cover design	
<input checked="" type="checkbox"/> Incl. seat support frame, adjustable in height, depth and inclination Required configuration: <input type="checkbox"/> no seat inclination <input type="checkbox"/> slight seat inclination <input type="checkbox"/> high seat inclination	<input type="checkbox"/> No back cushion (please tick if no cushion is required) ADDITIONAL COVERS for cushions as chosen on the right <input type="checkbox"/> 1 cover (..01) <input type="checkbox"/> 2 covers (..02)	<input type="checkbox"/> Medium-soft cushion foam plastic, 3 cm, with zipper, breathable cover (colour selection below)	Anatomically formed, incl. changeable cover (colour selection below) Cavity: <input type="checkbox"/> 3 cm (..04) <input type="checkbox"/> 5 cm (..06) <i>N° 891106 not with backsystem WITHOUT back tubes Only in combination with curved back plate</i>	The colour of the chosen covers can be selected below. -> choice of cover colour
			N° 8911.. £245	N° 85.. £ 0
			<input type="checkbox"/> ADDITIONAL COVER for anatomical back cushion as configured Customized product	<input type="checkbox"/> Back cushion as chosen, without cover
N° 1930 £ 0	N° 85.. £75	N° 8517 £139	N° 891110 £135	N° 998501 £30

Choice of Trevira cover colour Note: Color views may differ from reality depending on the screen view / printout and are only for initial orientation.

Please choose your colour of the selected covers:



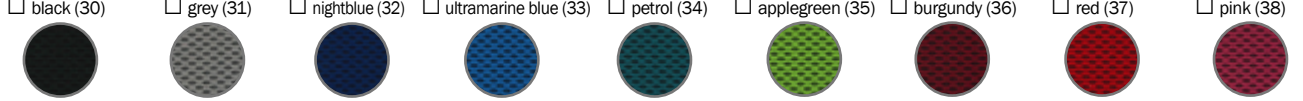

black (30)
 grey (31)
 nightblue (32)
 ultramarine blue (33)
 petrol (34)
 applegreen (35)
 burgundy (36)
 red (37)
 pink (38)





N° 80.. (seat cushion/anat. cushion) / **N° 85..** (back cushion/anat. back cushion) / **N° 6701..** (adjustable back cover)

Push handles			
Extendable standard push handles	Single-hand push handle	Push bow (with joint made of plastic or metal)	
Push handles extendable by straight: (recommended from SW26) <input type="checkbox"/> 25 cm (..02) <input type="checkbox"/> 35 cm (..03) cranked: <input type="checkbox"/> 25 cm (..06) <input type="checkbox"/> 35 cm (..04)	<input type="checkbox"/> Single-hand push handle, cranked, extendable by 22 cm, foldable and adjustable in angle by steel joint Permitted weight capacity max. 40kg Item only available until December 31, 2021.	<input type="checkbox"/> extendable by 20 cm, adjustable in angle joint made of plastic up to SW 30cm at SW20/22 and BH25/30 only limited height adjustment possible	<input type="checkbox"/> extendable by 20 cm, adjustable in angle joint made of metal, from SW 32cm at BH25/30 only limited height adjustment possible
N° 65.. £230	N° 660202 £277	N° 653101 £369	N° 653102 £369
<input type="checkbox"/> Extendable push handle with LONG handle (configure extension on the left) N° 65.. £230 <input type="checkbox"/> Extendable push handle with SHORT handle (configure extension on the left) Not in combination with drum brake! N° 65..+ N° 623702 £265			

Leg support with foot plate		Leg support options		
Model 1	Model 2	Locking device	Heel edge	Heel cups
<input type="checkbox"/> one piece, adjustable in height, depth and angle	<input type="checkbox"/> Retractable, central installation, hinged backwards, adjustable in height, depth and angle Only with LLL 15 cm or higher	<input type="checkbox"/> Locking for leg support Model 2 (N° 402503)	<input type="checkbox"/> For foot plate Not possible when combining leg support Model 2 (N° 402603) with SW 18/20 cm	Heel cups made of aluminium, self-installation <input type="checkbox"/> Size 1 (..01) (7x11.5 cm) <input type="checkbox"/> Size 2 (..02) (9x12.5 cm)
N° 402601 £ 0	N° 402603 £189	N° 4009 £59	N° 402505/401904 £59	N° 4020.. £52

Leg support with foot plate		User brakes		Companion brake
Model 1	Model 2	Bowden cable brake	Lockable user brake	Locking brake
				

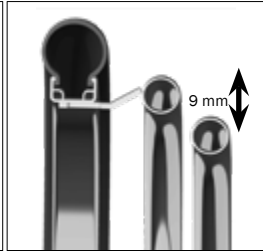
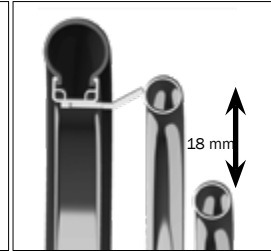
Wheels			Double handrim	
Standard wheel	Profile wheel	Lightweight wheel	Distance tight (only 9 mm)	Distance normal (Standard)
				

To see the latest versions of our order forms, please visit www.sorgrollstuhltechnik.de/download-portal

Side guard	User brakes		Companion brakes	
Standard	Bowden cable brake	Lockable user brake	Drum brake ¹	Locking brake
<input checked="" type="checkbox"/> Component of synthetic wheel cover and alu side guard	<input type="checkbox"/> Bowden cable brake, integrated in activity side guards, with ball knob	<input type="checkbox"/> Bowden cable brake, lockable in activated or deactivated position , integrated in activity side guards, with ball knob	<input type="checkbox"/> for standard-, profile- or lightweight wheels (N° 21..30/31), incl. braking lever for attendant if Bowden cable brake for the user is additionally required please tick also Article N° 353601 Not with 7° wheel camber / 9° wheel camber recommended	<input type="checkbox"/> Locking brake at the back of the rear wheels To lock in the resting state (No driving brake) Not in combination with drum brake (N° 220036)
N° 5025 £ 0	N° 353601 £ 0	N° 353603 £349	N° 220036 £289	N° 353602 £289

Wheel size and wheel camber	
Wheel size	Wheel camber
Size in inches <input type="checkbox"/> 18" (only for lightweight-wheels with standard hub, only up to seat depth 22) <input type="checkbox"/> 20" <input type="checkbox"/> 22" <input type="checkbox"/> 24"	Wheel camber, firmly welded <input type="checkbox"/> 9° £ 0 Assembly set camber 7°/11°, preinstalled for <input type="checkbox"/> 7° <input type="checkbox"/> 11°
£ 0	N° 201518 £69





Wheels			
Standard wheel	Lightweight wheel with standard hub	Double handrim (only with 20" to 24")	
<input type="checkbox"/> All-round wheel Additional weight of approx. 900g/wheel compared to lightweight wheels	<input type="checkbox"/> with standard hub Very lightweight, incl. aluminium handrim Weight reduction of approx. 900g/pair compared to standard wheels	with standard hub and double handrim, Only 7° and 9° camber Mounting <input type="checkbox"/> left <input type="checkbox"/> right	<input type="checkbox"/> Handrim for opposite site
N° 21..30 £ 0	N° 21..77 £ 0	N° 2614 £929	N° 261435 £139
Profile wheel	Lightweight wheel with drum brake hub	with drum brake hub and double handrim Only at 9° camber	Distance of handrims
<input type="checkbox"/> Unity of handrim and rim, reduces the risk of finger injuries Additional weight of approx. 800g/wheel compared to lightweight wheels	<input type="checkbox"/> with drum brake hub , incl. black aluminium handrim Only in combination with N° 220036 (AC 310,- €) and only at a camber of 11°! Weight reduction up to 1,1 kg/pair compared to drum brake wheels	Mounting <input type="checkbox"/> left <input type="checkbox"/> right	<input type="checkbox"/> standard 18mm (...11) <input type="checkbox"/> tight 9mm (...12) Distance tight: Not in combination with handrim cover or coated handrim
N° 21..31 £ 0	N° 21..82 £ 0	N° 2615 £1050	N° 26.. £ 0

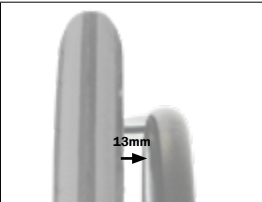
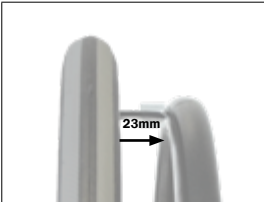
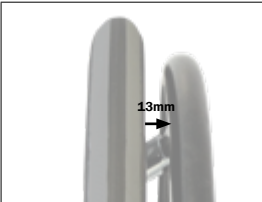
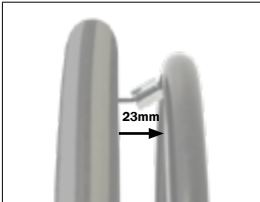

Tyres		
Standard	Standard	Performance
Pneumatic: <input type="checkbox"/> Schwalbe <i>Right Run</i> 1" (...13)	Solid: <input type="checkbox"/> Standard tyres 1" (...11) Not available for 18" wheels	Pneumatic: <input type="checkbox"/> Schwalbe <i>Marathon Plus</i> , pneumatic flat free tyres 1" Only for 22" and 24" wheels
N° 20.. £ 0	N° 23.. £ 0	N° 20..12 £65



¹ When mounting the drum brake in combination with an 11° camber, wheel sizes 22" and 24" may be restricted when the seat width grows.

To see the latest versions of our order forms, please visit www.sorgrollstuhltechnik.de/download-portal

Mounting of handrims Please indicate the desired kind of mounting!			
Standard tight	Standard wide	High tight	High wide
			

Handrim options			
Silicone cover	Ergo rubber inlay	Maygrepp handrim	Ergonomic handrim
			

Caster wheels			
Standard PU	Standard solid rubber	Design PU	Design solid rubber
			

Caster forks	
Standard Aluminium	Design Aluminium
	 <i>(Colour example)</i>

To see the latest versions of our order forms, please visit www.sorgrollstuhltechnik.de/download-portal

Handrims / Handrim options			
Mounting and material	Mounting on lightweight wheels	Ergonomic	Design handrims
<input type="checkbox"/> Standard / tight <input type="checkbox"/> Standard / wide <input type="checkbox"/> High / tight <input type="checkbox"/> High / wide Material: <input type="checkbox"/> Stainless steel (...01) <input type="checkbox"/> Alu, silver anodized (...75)	<input type="checkbox"/> Standard / tight <input type="checkbox"/> Standard / wide <input type="checkbox"/> High / tight <input type="checkbox"/> High / wide Material: Alu Selection standard or high not possible with lightweight wheel drum brake	<input type="checkbox"/> handrim with ergonomic handrim profile, black anodized with built-in rubber grip only for 24" wheels	<input type="checkbox"/> Aluminium handrims coated in frame colour
N° 30.. £ 0	N° 30..75 £ 0	N° 342424 £369	N° 303000 £69

Handrim options			
Silicone <small>Not for double handrim 20"</small>	PVC	Ergo rubber inlay	Maxgrepp handrim
Detachable silicone cover, black (soft surface) Not available for 18" wheels <input type="checkbox"/> for standard wheel (20-24) <input type="checkbox"/> for profile wheel (...02) <input type="checkbox"/> for lightweight wheel (...05)	<input type="checkbox"/> Handrim coated with black PVC, (Tetra Grip) Only for standard and lightweight wheels	<input type="checkbox"/> Rubber inlay, 13 mm wide, Only for profile wheels	<input type="checkbox"/> Allows pushing with the heel of hands (soft surface), only for standard and lightweight wheels Not available for 18" wheels
N° 32.. £139	N° 33.. £325		
For double handrim Detachable silicone cover, black <input type="checkbox"/> for inside rim <input type="checkbox"/> for outside rim <input type="checkbox"/> for opposing side Not in combination with double handrim distance tight N° 2612	For double handrim <input type="checkbox"/> Handrim coating for double handrim, both handrims (inside and outside), coated with black PVC N° 262402 £319 <input type="checkbox"/> Handrim coating for opposing side of the double handrim, coated with black PVC		
N° 3205 £69	N° 262401 £179	N° 32..01 £182	N° 34.. £399

Spoke cover	Design spoke covers / Design curved back		
Transparent	Design spoke covers	Design curved back	
<input type="checkbox"/> transparent (...00)	<input type="checkbox"/> www.speichen-schutz.de Not available for 18" wheels	<input type="checkbox"/> www.wheelchairgadgets.com Not available for 18" wheels	<input type="checkbox"/> Optional: child's name on spoke cover Name: Only for Design Decor <input type="checkbox"/> Foil for curved back plate with the same design as the specified spoke cover Only with curved back plate
N° 25.. £149	N° 25..26 TBD	N° 25..27 TBD	N° 2527 TBD

Caster wheels				Caster forks
Standard PU	Standard solid rubber	Design PU	Design solid rubber	Standard Aluminium
Polyurethane <input type="checkbox"/> 4" (2812) <input type="checkbox"/> 5" (2805) With 18" rear wheels only 4" caster wheels possible	Solid rubber: <input type="checkbox"/> 4" (2804) <input type="checkbox"/> 5" (2809) With 18" rear wheels only 4" caster wheels possible	Polyurethane, transparent, with LEDs: <input type="checkbox"/> 4" (2820) <input type="checkbox"/> 5" (2834) With 18" rear wheels only 4" caster wheels possible	Solid rubber, black, with aluminium rim <input type="checkbox"/> 4" (2835) <input type="checkbox"/> 5" (2836) With 18" rear wheels only 4" caster wheels possible	<input type="checkbox"/> Aluminium fork, black anodized N° 2826 Design Aluminium <input type="checkbox"/> Aluminium fork coated in frame colour N° 2829 £69
£ 0	£ 0	£ 0	£ 0	

Steering options	
Track fixation	Locking mechanism
<input type="checkbox"/> track fixation (straight) (Not in combination with shock protection N° 9102)	<input type="checkbox"/> Locking mechanism for track fixation (Not in combination with shock protection N° 9102)
N° 2851 £145	N° 2850 £179



To see the latest versions of our order forms, please visit www.sorgrollstuhltechnik.de/download-portal

Frame options			
Anti tipper	Outdoor Front End	Water bottle	Sun shade
			<p>Removable sun shade. Easily adjustable in height and position by flexible holder.</p>

Standard head rests <small>Measures in mm (all measures ± 10mm)</small>	Lightweight head rest <small>Measures in mm (all measures ± 10mm)</small>												
Model 1 	for weight reduction <p>⚠ Not approved as a headrest for transport in a motor vehicle.</p> <p>Pad sizes:</p> <table border="1"> <thead> <tr> <th></th> <th>size 1</th> <th>size 2</th> </tr> </thead> <tbody> <tr> <td>height</td> <td>110</td> <td>130</td> </tr> <tr> <td>width</td> <td>200</td> <td>260</td> </tr> <tr> <td>depth</td> <td>30</td> <td>40</td> </tr> </tbody> </table>		size 1	size 2	height	110	130	width	200	260	depth	30	40
		size 1	size 2										
height		110	130										
width		200	260										
depth	30	40											
Model 3 													
Model 4 													

Belt systems		Lateral support	Therapy tables
2-point pelvic belt with plastic fastener 	4-point pelvic belt with metal fastener 	Size 1, incl. linkage, adjustable holder 	Transparent
Chest-shoulder belt 	Protection cap only for metal fastener 		Pad, incl. removable cover black (only for holder size 1) 10x7 cm (.04) 10x9 cm (.05)

To see the latest versions of our order forms, please visit www.sorgrollstuhltechnik.de/download-portal

Frame options					
Anti tipper	Outdoor Front End	Splash guard	Step tube	water bottle	
Swing-away installation Mounting <input type="checkbox"/> left <input type="checkbox"/> right <input type="checkbox"/> pair (with 20" wheel from SW22)	<input type="checkbox"/> Outdoor Front End, facilitates significantly active and passive driving on soft or rough surfaces, incl. mounting aid No simultaneous use possible with therapy table or abduction wedge	<input type="checkbox"/> Splash guard for Outdoor Front End, made of plastic 	<input type="checkbox"/> Step tube	<input type="checkbox"/> Water bottle 750ml, light PET-bottle, incl. holder	
N° 7213 £149	N° 599536 £399	N° 59951212 £65	N° 7408 £65	N° 790101 £35	
Bumper	Wheel base extension	Sun shade			
<input type="checkbox"/> Bumper, made of rubber to protect furniture, doors, etc.  Frame form „Taurus“ not possible with Restraint system.	<input type="checkbox"/> Wheel base extension by 4 cm to the back. Enables advanced settings of the center of gravity Only possible with adjustable back angle N° 627801. Attention: Return to standard wheel position only possible by new side guards!	<input type="checkbox"/> variable adjustable sun shade, in black Usable height (from the top edge of the seat plate/seat cover to the apex) = selected back height + 40 cm Example: BH 30 + 40 cm = 70 cm			
N° 9102 £51	N° 760177 £229	N° 910301 £220			

Positioning aids			
 <p>Here you will find a small selection to mark. You will find more positioning aids, corresponding mounting possibilities and further equipment in the separate order form „Positioning aids“</p> <p>Order form „positioning aids“, available in download area.</p> <p>e.g.:</p> <ul style="list-style-type: none"> • belts, • fixations and corresponding connections, • abduction wedges, • side truss pads, • head rests, • and more... <p>On the order form refer to this new wheelchair order/enquiry.</p>			
2-point pelvic belt	4-point pelvic belt	Standard head rests	Lightweight head rest
<input type="checkbox"/> with plastic fastener £119 <input type="checkbox"/> with metal fastener £139 The size is determined by us according to the chosen wheelchair measurements.	<input type="checkbox"/> with plastic fastener £149 <input type="checkbox"/> with metal fastener £179 The size is determined by us according to the chosen wheelchair measurements.	All head rests including connection <input type="checkbox"/> Model 1, (...21) shell-shaped small <input type="checkbox"/> Model 3, (...23) curved small <input type="checkbox"/> Model 4, (...24) curved large	Lightweight head rest, adjustable with two conical joints, connection and removable cover included. (cover with same-color as back cushion) <input type="checkbox"/> Size 1 (...20) Pad size 110x200mm <input type="checkbox"/> Size 2 (...21) Pad size 130x260mm Weight reduction approximately 700-1000g to standard head rest systems Not approved as a headrest for transport in motor vehicle.
N° 780502	N° 780504	N° 6860..	N° 686009..
£177	£15	£266	£269
Chest-shoulder belt	Protection cap		
<input type="checkbox"/> Chest-shoulder belt without zipper	<input type="checkbox"/> protection cap for metal fastener Makes independent opening for the patient difficult.		
N° 7810	N° 78050210		

Lateral support (at back system with tubes only from BH 30)		Therapy table	
Swing-away laterals, small, up to max 35kg	Transparent	Design	
Adjustable holder, Size 1, incl. linkage (without pad) <input type="checkbox"/> for left side (...01) <input type="checkbox"/> for right side (...02)	Pad, incl. removable cover black (only for holder of size 1) 1 pcs. 2 pcs. <input type="checkbox"/> 10x7cm (...04) <input type="checkbox"/> 10x9 cm (...05) N° 685901.. £51 Additional extension of joint (3.8 cm) for small pads 1 pcs. 2 pcs. <input type="checkbox"/> <input type="checkbox"/>	Central installation, plugged under seat plate, adjustable in height and distance <input type="checkbox"/> Size 0 (...10) (39 cm width, recommended for SW 18-24) <input type="checkbox"/> Size 1 (...11) (46 cm width, recommended for SB 26-34) No simultaneous use possible with Outdoor Front End	<input type="checkbox"/> Number of design for transparent therapy table according to wheelchairgadgets.com
N° 685901.. £179	N° 68590103 £56	N° 9209.. £312	N° 920099 £84

Frame options

Retaining eyelets

Transport brackets (4 pieces)
 for transportation in a handicapped accessible passenger car

N° 58507710 **£329**

Electric drives and systems		
Recommendations	Provider	Information
1. For all possible drives and systems we recommend casters of 5". 2. Please regard the respective mounting possibilities and specifications given on the homepages indicated on the right	for example www.aat-online.de or www.alber.de	Restrictions and adjustments to the installation and the final configuration of the wheelchair are the responsibility of the providers of the additional systems.

Seat heights

All specifications measured WITHOUT cushions!
All specifications ±5 %

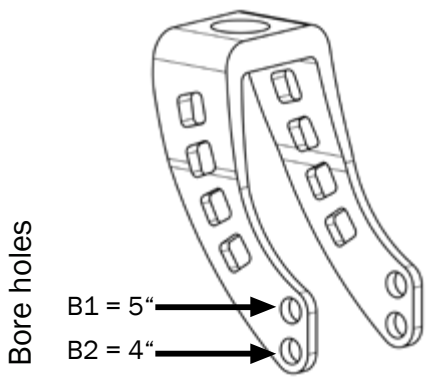

wheel combination	Seat height front measured WITHOUT CUSHION from seat edge to floor at horizontal seat				
	Höhe 1	Höhe 2	Höhe 3	Höhe 4	Höhe 5
18" x 4" (in 18"-Gabel)	31,5 cm	33 cm	34,5 cm	36 cm	-
20" x 4" (=B2)	34 cm	35,5 cm	37 cm	38,5 cm	40 cm
20" x 5" (=B1)	34 cm	35,5 cm	37 cm	38,5 cm	40 cm
22" x 4" (=B2)	36 cm	37,5 cm	39 cm	40,5 cm	42 cm
22" x 5" (=B1)	36 cm	37,5 cm	39 cm	40,5 cm	42 cm
24" x 4" (=B2)	38,5 cm	40 cm	41,5 cm	43 cm	44,5 cm
24" x 5" (=B1)	38,5 cm	40 cm	41,5 cm	43 cm	44,5 cm

Terms and Conditions

1. Preface and Scope

(1) Our terms and conditions apply exclusively. Any deviating, opposing, or complementing terms and conditions on the part of the business partner do not form integral part of contract unless explicitly approved of by us. There are no exceptions to the consent requirement, which also applies in cases where we conduct deliveries without restrictions while aware of the business partner's terms and conditions. (2) Agreements made in the individual case with the purchaser (including side-agreements, supplements, and alterations) always take priority over these terms and conditions. A contract or our confirmation - both in written form - are authoritative for the content of such arrangements. (3) Any legally relevant declarations and notifications the purchaser submits to us after conclusion of the contract (e.g. setting of deadlines, notice of defects, declarations of rescission or abatement) require the written form to be valid. (4) Any information on the application of legal regulations serves the mere purpose of clarification. All regulations are legally binding without any such clarifications unless explicitly altered or excluded in these terms and conditions.

2. Prices

All prices are ex works, excluding insurance and packaging. The prices are net prices; the value-added tax is stated and charged separately according to the legally binding rate at the time of invoicing. The prices valid on the day of delivery are binding unless explicitly arranged otherwise.

3. Conclusion of Contract

SORG's offers are invitatio ad offerendum (invitations to treat). Ordering goods counts as an obligatory offer of contract on the part of the purchaser. Unless the order suggests otherwise, we have the right to accept this contract offer within two weeks time after reception. The acceptance of an offer of contract is effected by the confirmation of the order.

4. Terms of Payment

(1) Provided that no other agreements exist, payment is to be made by paying in advance - 50% at placing of order, 50% pre-delivery of goods. The purchaser bears any costs arising from transactions or discounting. (2) If a 30-day payment deadline is exceeded, a delay rate of 9% on top of the respective base rate of the European Central Bank falls due without the need for prior notices. Beyond that, the purchaser is charged 3,- € for any reminder sent. We reserve the right to make use of the commercial due rate according to § 353 HGB. A higher damage for delay may be enforced via a suitable verification.

5. Offers and Validity

All current price lists are generally valid until December 31 of the respective year, or until new price lists are published. The latest version of the price list will always be provided on our homepage. Offers older than 3 months at that point expire and must be replaced with new offers and prices.

6. Time of Delivery and Delay

We state the terms of delivery when accepting the order. The delivery date is non-binding and has mere guideline value - especially with regard to customised products. The terms for delay in delivery are defined by legal regulations. In any case, a writing notice issued by the purchaser is necessary for them to take effect.

7. Force Majeure (Act of God)

(1) SORG is not to be held responsible for the following delays of delivery. This also applies if these causes occur with respect to legal representatives, auxiliary persons, or deliverers of SORG: Circumstances of force majeure as well as other extraordinary events that are unpredictable and unavoidable for, and not caused by, SORG, and that only occur after ordering or reserving, and that SORG could not have known about. Moreover, this applies in case of strikes, fire, floods, labour disputes, business disruptions, altered magisterial approbation and legal situation, and magisterial orders which are not due to operational risks. (2) In the cases of paragraph 1, SORG is eligible to delay delivery/performance for the time of hindrance as well as an appropriate start-up time. If SORG thus causes unacceptable complications for the purchaser, both SORG and the purchaser are eligible to withdraw from the contract. Circumstances that only lead to a temporal and hence acceptable delay of delivery and performance are excluded from this right. The legal rights of the client remain unaffected.

8. Dispatch

We generally dispatch uncovered by insurance and at the recipient's risk. We transfer the risk of coincidental loss or deterioration of the goods as well as delay on to the client at the moment of passing the goods on to the forwarder, bearer, or any other person/institute responsible for delivery. SORG will make any effort to respect the client's wishes in terms of path and kind of delivery. Any costs caused by this (including agreed carriage free delivery) are to be covered by the client. In the case of carriage free delivery conducted by SORG, the recipient is required to put forward any carriage costs for a refund. If the client wishes the dispatch to be delayed, any risk of loss or deterioration of the goods is carried by the recipient from the first day of readiness for dispatch. The goods dispatched are only insured upon special demand and at the cost of the recipient.

9. Damage through Delivery Angelieferte Gegenstände sind, auch wenn sie unwesentliche Mängel Upon delivery, the goods need to be checked for obvious damage in the presence of the bearer. Any damage is to be documented in a written form and co-signed by the bearer. This protocol is to be forwarded to us immediately. Delayed reclamations, or reclamations not signed by the bearer, cannot be taken into account.

10. Warranted Features, Receipt, and Technical Alterations

Delivered objects, even with minor damage, are to be accepted by the client, even if §433, paragraph 1 BGB is not fulfilled. Partial deliveries are permissible. Features only count as warranted if explicitly designated as such. A warranty of condition can only be asserted explicitly and in a written form. SORG reserves the right for technical alterations, especially for solutions of equal or higher value.

11. Warranty for Defects

(1) SORG warrants for any defects of delivered new goods for 12 months as long as the purchaser is not the user (§§ 474, 13 BGB). Should the purchaser be the user then the warranty period is two years for new goods, for used goods 12 months. Should the purchaser also be an entrepreneur, then the liability for used items is void, as long as there is no claim for compensation according to N° 12. (2) The purchaser's claim for defects presuppose that he has attended his obligation to give notice of defects on the legal grounds for his reasons of inquiry (§§ 377, 381 HGB). If defects are found during the inspection or at a later point, we are to be notified in writing without delay. The notice counts as not delayed if issued within two weeks. Posting the notice on time suffices for the keeping of the term. Independently from this obligation to inspect and give notice, the purchaser is to report obvious defects (including wrong and short delivery) within two weeks upon delivery (again, posting the notice on time suffices). If the purchaser misses the proper inspection and/or notice of defects, we do not warrant for the reported defects. If the delivered good is defected, we may choose to conduct supplementary performance either by repairing the defect (subsequent improvement) or by delivering flawless goods (compensation delivery). Our right to refuse the chosen method of supplementary performance on the respective legal grounds remains untouched. (3) Our liability for defects expires when alteration or maintenance works are done by the client or a third-person-party without our prior written permission. Consequences of excessive strain, negligent or

incorrect handling, and violent damage are excluded from the warranty for defects.

12. Further Liability

(1) With respect to compensation - regardless of the legal cause - SORG is only liable in case of malice and act of gross negligence. In case of slight negligence, SORG is only liable for damage of life, body, health, and for damage caused by the negligence of an essential contractual obligation (an obligation whose fulfilment make the proper realisation of the contract possible in the first place and in whose fulfilment the contract partner regularly trusts and can trust). In this case, however, our liability does not exceed the covering of predictable, typically occurring damage. (2) A free right to termination on the part of the purchaser (acc. to § 651, 649 BGB in particular) is precluded. Otherwise, the usual prerequisites and legal consequences apply.

13. Costs of Supplementary Performance

Costs of supplementary performance cannot be charged on SORG's account.

14. Voluntary Withdrawal of Goods

SORG is not obliged to take back any delivered end products or parts thereof. If SORG voluntarily decides otherwise in individual cases (especially for therapeutically altered requirements or deaths), SORG refunds a maximum of 75% of the delivery costs for unused parts whose delivery does not date back more than three months. There is no legal obligation concerning withdrawal in this respect. Deliveries which date back more than three months as well as sewed parts and customised products are not returnable. A copy of the delivery note or the bill serves as proof of age of delivery.

15. Reservation of Ownership

Goods delivered by SORG remain the property of SORG until any obligations from the parties' business contract on the part of the purchaser have been redeemed. This also applies if SORG has adapted individual or all claims into a running account which has been balanced and acknowledged. The purchaser has the right to dispose of the goods in the proper course of business. The purchaser hereby yields all claims to SORG which arise from the resale against the purchaser or third parties. The purchaser is authorised to withdraw these claims even upon conveyance. SORG's right to withdraw the claims remains untouched. However, SORG is obliged not to withdraw the claims as long as the purchaser complies with his duty of payment and any other duties. SORG has the right to demand that the purchaser makes known the yielded claims and their debtors, that he provides all information necessary for conveyance, and that he hands in all associated documents. As long and insofar the reservation of ownership is intact, the purchaser must not transfer any goods for securing or bailment without SORG's permission. The purchaser may process or alter the goods for the benefit of SORG exclusively. If processed with other goods which do not belong to SORG, SORG obtains co-ownership of these new goods in relation to the invoice value to the cost price of the other processed goods. If a third party interferes with SORG's ownership, the purchaser is to notify SORG immediately. The purchaser must not make any agreements with other purchasers which may exclude or limit SORG's rights. In particular, the purchaser must not make any agreements which destroy or limit the advance assignments to SORG. If the estimated value of the existing guarantees exceeds the claims to be ensured by more than 20%, SORG is insofar obliged to release by request of the purchaser.

16. Copyright Protection

If SORG conveys any images, drawings, indications of weight or measurements, technical documentations, or other product descriptions and documents (including electronic ones), the respective indications only apply if explicitly stated that they do. SORG reserves ownership and copyright of all these documents. They may only be made available to third parties upon SORG's explicit permission.

17. Place of Fulfilment, Place of Jurisdiction, and Severability Clause

(1) The law of the Federal Republic of Germany applies for these Terms and Conditions and all legal relations between us and our business partners. All international and supranational (contractual) legal systems, the UN Convention on Contracts for the International Sale of Goods in particular, are hereby excluded. Prerequisites and effects of the reservation of ownership acc. to no. 15 are subject to the right of the respective storage location of the good if the choice of law made in favour of the German law is illegitimate or ineffective. The only place of jurisdiction (also on an international basis) for any disputes arising directly or indirectly from the contractual relationship is, according to German Commercial Code, our office in Oberhausen-Rheinhausen, Germany. However, we also have the right to file a suit concerning the general jurisdiction of the purchaser. (2) If any clause in these Terms of Conditions should turn out to be ineffective, this does not affect the effectiveness of all other clauses.

Technical alterations and misprints reserved. As of: January 2017

SORG Rollstuhltechnik GmbH + Co. KG
Benzstr. 3-5, 68794 Oberhausen-Rheinhausen / Germany
Phone +49 7254 / 9279-0
Fax +49 7254 / 9279-10
info@sorgrollstuhltechnik.de, www.sorgrollstuhltechnik.de