



FOLDING WHEELCHAIR

0070757A-00-v11-MC FOLDING WHEELCHAIR MANUAL-ENGLISH

User Manual

Ultralight Folding Wheelchair



GO BEYOND



MOTION
COMPOSITES

Maintenance manual & warranty information

Dealer: This manual must be given to the user of the Motion composites wheelchair before its first use.

User: Prior to using the Motion composites wheelchair, carefully read this manual and keep it for future reference. For more information about this product, its parts/accessories and the services provided, please visit : www.motioncomposites.com

Motion composites wheelchair HELIO C2, A7, A6, VELOCE, XC2, MOVE, KIDS

Thank you for selecting the Motion composites wheelchair. Please do not hesitate to send us your feedback or questions regarding this product's reliability, safety, usability, as well as any repair/maintenance services offered by an authorized Motion Composites dealer.



WARNING - READ THIS MANUAL

Do not operate this wheelchair without reading and understanding this owner's manual. If you are unable to understand the warnings, cautions and instructions, contact your Motion Composites dealer or customer support at 1-866-650-6555 before attempting to use this wheelchair.

If you ignore these Warnings or fail to inspect or maintain your wheelchair as directed in the manual, you may fall, tip over or lose control of the wheelchair and seriously injure yourself or others or damage the wheelchair.

Made in Canada

with Canadian and imported parts

Contact information:

Motion Composites Inc.
160, Armand-Majeau Sud
Saint-Roch-de-l'Achigan, Quebec
J0K 3H0 Canada
Phone: 1-866-650-6555
Fax: 1-888-966-6555
support@motioncomposites.com
www.motioncomposites.com



European
authorized
representative :

Advena Ltd
Tower Business
Centre, 2nd Flr.
Tower Street
Swatar,
BKR 4013, Malta

Sophisticated meets affordable

We took the knowledge acquired through the creation process of the Helio C2 and made it available in an entry-level package. By using the latest hydroforming technologies and a high-performance aluminum alloy, we created a complete lineup of Motion Composites ultra-light and propulsion-efficient wheelchairs, with an affordable price tag.

One of the lightest wheelchair of its class

We are unrivaled when it comes to lightness, no matter the material. Thanks to cutting edge design paired with the outstanding properties of Carbon fiber, and or 7000 serie aluminum, a Motion Composites wheelchair with a standard configuration weighs up to 5 pounds less than the other popular wheelchairs in its category.

What a folding wheelchair should be.

Every little detail of the Motion Composites wheelchair was specifically optimized to help you go farther! Our wheelchair lets you minimize the risk of long-term shoulder and joint injuries by alleviating the energy needed to propel. Whether you push it forward or lift it in the trunk of a car, the Motion Composites wheelchair gives you more freedom!

Adjustability without the weight.

The Motion Composites wheelchair is completely adjustable for a perfect fit. You can easily adjust front and rear seat-to-floor heights, seat angle, center of gravity and frame angle. All of the options offered on our line of wheelchairs are also compatible with the Veloce for true customization.

The lowest seat-to-floor height.

The innovative frame design of the Motion composites wheelchair lets you achieve up to 13" seat-to-floor height with a 4" caster on a standard frame. That's the same frame that can go up to 21 1/4"!

Get more mileage out of your energy.

Everybody benefits from an easier to propel wheelchair. Featuring an entirely symmetrical carbon fiber or hydroformed crossbrace, oval shaped tubes and oversized pivot axles, our unique Ultrarigid Folding System (UFS) maximizes frame rigidity and energy conservation.

Important information

If you have any questions about safety, adjustments, accessories, use, or maintenance, please contact your authorized Motion Composites dealer. Please record the following information for future reference:

Date of purchase _____
Serial Number _____
Supplier _____
Address _____
Telephone _____



High-Modulus Carbon T700 - The lightest and most rigid material available, also renowned for its vibration dampening properties.



Ultralight Aluminum 7005 T6 - An aluminum alloy that is renowned for its high strength-to-weight ratio.



Rigid Unibody Frame - A unibody frame is much stronger and needs less maintenance than a standard two-part frame. It also reduces weight while maximizing propulsion efficiency.



Symmetrical Crossbrace 3D Entirely symmetrical crossbrace for reduced torsion and a better distribution of forces throughout the frame.. (Except MOVE model)



optional: HD Kit with Reinforced Crossbrace 350 lb (159 kg) - Same properties as the Symmetrical Molded Crossbrace 3D with added reinforced carbon fiber gives 350 lb (159 kg) weight capacity.



Ultrarigid Folding System - Extremely precise tolerances and oversized pivot axles for best-in-class propulsion efficiency.



Forged Vertical Axleplate - Offers the most precise rear wheel adjustability of the industry. The vertical mounting maximizes rigidity and responsiveness.



Evolve Caster Housing - Imbedded inside the frame for rock solid durability, the Evolve Caster Housing offers easy and precise infinite adjustments.



AFS Anti-Flutter System -Minimize flutter with a simple twist of a screw. (Except Veloce model)



Newton Accessories - The whole range of newton accessories are designed to be light and offer improved functionalities.



WARNING - WHEELCHAIR SELECTION

Motion Composites manufactures different models of wheelchairs to meet the needs of the end users. However, Motion Composites is not a health care advisor, and we are not aware about the individual condition or needs of the wheelchair user. Therefore, the final selection of the particular model, how it is adjusted, the type of options and accessories, rest solely with the wheelchair user and the health care professional adviser. Choosing the best chair and setup for your safety depends on the following criteria:

1. Your disability, strength, balance and coordination;
2. The types of hazards you must overcome in daily use (where you live and work and other places you are likely to use your chair); and
3. Your need for options for your safety and comfort (such as anti-tippers, positioning belts or special seating systems). If you ignore this warning, you may endanger your health.



WARNING - TIE-DOWN SYSTEM

Motion Composites recognizes that the safest transportation option for a person in a wheelchair is to install the person in an appropriate seat in the vehicle and to use the safety seat belt system of the vehicle. If a paratransit system is to be used, ensure that the wheelchair is equipped with the Motion Composites anchor system. It must also be ensured that the straps, hooks and tie-downs of the Paratransit Vehicle's tie-down system meet the safety standards of the province, state or country where the user is being transported, and installed according to the tie-downs manufacturer's standards. Motion Composites can not recommend, and does not recommend, tie-downs or manufacturers of tie-down systems.



WARNING - SEATING RESTRAINTS

It is the obligation of your dealer and health care professionals who are advising you to determine if you require a seating restraint or positioning system in order to ensure that you can safely operate your wheelchair. Serious injury can occur in the event of a fall from a wheelchair.



The information contained in this document is subject to change without notice. The most recent documents, updates and the latest version of this Owner's Manual are available on www.motioncomposites.com.

Table of contents

WELCOME TO Motion composites wheelchair	2
CONTACTING US	
IMPORTANT INFORMATION	
TABLE OF CONTENTS	4
3. PRODUCT OVERVIEW	5
PARTS LIST	
4. BEFORE USE	6
4.1 GENERAL WARNING	
4.1.1 SAFETY INSPECTION AND MAINTENANCE	
4.1.2 MOTOR VEHICLE SAFETY	
4.1.3 ACCLIMATING TO YOUR NEW WHEELCHAIR	
4.1.4 NOTE TO USERS	
4.1.5 IMPORTANT WARNING WHEN USING THE STROLLER-HANDLE	
4.1.6 NOTE TO DEALERS & QUALIFIED TECHNICIANS	
4.2 SYMBOLS	7
5. TUTORIAL	7
6. TECHNICAL SPECIFICATIONS	
6.1 BACK UPHOLSTERY	
6.1.1 CUSHION	
6.1.2 ARMREST PAD	
6.2 LABEL LOCATIONS	
6.3 STRUCTURE	8
6.4 DIMENSION	
6.5 ADJUSTABILITY	
7. SAFETY	9
7.1 PERIODIC CHECKLIST	
7.2 WEIGHT LIMITATION	
7.3 WEIGHT TRAINING AND SPORTING ACTIVITIES	
8. RIDING YOUR MOTION COMPOSITES WHEELCHAIR	9
8.1.1 TO REDUCE THE RISK OF ACCIDENT	
8.1.2 ENVIRONMENTAL CONDITIONS	
8.1.3 CAREGIVERS	
8.2 RIDING YOUR WHEELCHAIR	10
8.2.0 IN ORDER TO REDUCE THE RISK OF A TIP-OVER	
8.2.1 BALANCE POINT	
8.2.2 WHEELIES	
8.2.3 TRANSFERRING	
8.2.4 GETTING DRESSED	
8.2.5 REACHING/LEANING/BENDING	
8.2.6 MOVING BACKWARDS	
8.2.7 RAMPS, SLOPES & SIDE HILLS	
8.2.8 OBSTACLES	11
8.2.9 CURBS AND STEPS	
8.2.10 MOVING WITH ASSISTANCE	
8.2.10.1 CLIMBING A CURB OR SINGLE STEP	
8.2.10.2 DESCENDING A CURB OR SINGLE STEP	12
8.2.11 STAIRS	
8.2.12 CLIMBING A FLIGHT OF STAIRS WARNING	
8.2.13 DESCENDING A FLIGHT OF STAIRS WARNING	
8.2.14 ESCALATORS	
9. HOW TO USE YOUR MOTION COMPOSITES WHEELCHAIR	12
9.1 FOLDING & UNFOLDING	
9.1.1 FOLDING	
9.1.2 UNFOLDING	13
9.2 WHEEL LOCKS	
9.3 FRONT RIGGINGS	
9.3.1 INSTALLING	
9.3.2 UNINSTALLING	
9.4 FOOTREST	
9.4.1 ELEVATING LEGREST	14
9.4.1.1 INSTALLING THE ELEVATING LEGREST	
9.4.1.2 ADJUSTING THE ELEVATING LEGREST	
9.5 ARMRESTS	
9.5.1 FLIP-BACK ARMRESTS	
9.5.2 REMOVABLE T ARMRESTS	
9.5.3 SWING-AWAY ARMRESTS	
9.6 SEAT BELTS	
9.6.1 AUTO BUCKLE AND AIRCRAFT BUCKLE SEATBELTS	
9.6.2 VELCRO™ BELT	
9.7 ANTI-TIPPERS	15
9.8 REAR WHEELS AXLES	

9.8.1	QUICK-RELEASE AXLES	
9.8.2	FIXED AXLES	
9.9	SEAT SLINGS	
9.10	PUSH HANDLES	
10.	ADJUSTMENTS AND MAINTENANCE OF YOUR MOTION COMPOSITES WHEELCHAIR	16
10.1	SERVICE	
10.2	REPLACEMENT PARTS	
10.3	TOOLS NEEDED	
10.4	GENERAL MAINTENANCE	
10.4.1	TIRE PRESSURE	
10.4.1.1	PUNCTURE	
10.4.2	CLEANING YOUR WHEELCHAIR	
10.4.3	STORING AND SHIPPING YOUR WHEELCHAIR	
10.5	BACKREST	17
10.5.1	REMOVING/INSTALLING THE BACK CANES	
10.5.2	ADJUSTING THE BACK ANGLE	
10.5.3	REMOVING/INSTALLING THE SEAT BELT	
10.5.4	ADJUSTING THE BACKREST HEIGHT	
10.5.5	INSTALLING/REMOVING STANDARD BACK UPHOLSTERY	18
10.5.6	INSTALLING/REMOVING ADJUSTABLE TENSION BACK UPHOLSTERY	
10.6	ARMREST	
10.6.1	INSTALLING FLIP-BACK ARMRESTS	
10.6.2	ADJUSTING THE HEIGHT OF FLIP-BACK ARMRESTS	
10.6.3	INSTALLING REMOVABLE T-ARMRESTS AND RIGID SIDEGUARD	
10.6.3.1	INSTALLING THE SIDEGUARD CLAMPS	19
10.6.4	REPLACING ARMREST PAD	
10.6.5	INSTALLING THE SWING-AWAY ARMREST RECEIVER	
10.6.6	ADJUSTING SWING-AWAY ARMREST HEIGHT	
10.7	FOOTREST LENGTH	
10.7.1	ADJUSTING FOOTREST LENGTH	
10.7.2	ADJUSTING FOOTPLATE ANGLE	20
10.7.3	INSTALLING AND ADJUSTING THE LIMB SUPPORT	
10.7.3.1	CLEANING THE LIMB SUPPORT	
10.8	SEAT	
10.8.1	REPLACING SEAT UPHOLSTERY	
10.9	SEAT-TO-FLOOR HEIGHT	
10.9.1	CHANGING THE FRONT SEAT-TO-FLOOR HEIGHT	
10.9.2	CHANGING REAR SEAT-TO-FLOOR HEIGHT	
10.9.3	CHANGING FRONT & REAR SEAT-TO-FLOOR HEIGHT	
10.10	FRONT CASTERS, FORKS AND FORK STEM ASSEMBLIES	21
10.10.1	REMOVING/INSTALLING/REPOSITIONING THE FRONT WHEELS	
10.10.2	REMOVING/INSTALLING THE CASTER HOUSING	
10.10.3	REMOVING/INSTALLING THE STEM BOLT ASSEMBLY	
10.10.4	ADJUSTING THE CASTER HOUSING ANGLE	
10.11	REAR WHEELS	22
10.11.1	ADJUSTING QUICK-RELEASE AXLES	
10.11.2	REPLACING/ADJUSTING HAND RIMS	
10.11.3	ADJUSTING THE REAR AXLE HEIGHT	
10.11.4	ADJUSTING REAR WHEEL SPACING	23
10.11.4.1	ADJUSTING REAR WHEEL SPACING	
10.12	WHEEL LOCKS	
10.12.1	REPLACING/ADJUSTING THE WHEEL LOCKS	
10.13	LOCK EXTENSIONS	
10.13.1	REPLACING/ADJUSTING THE LOCK EXTENSIONS	
10.14	ANTI-TIPPERS	24
10.14.1	ADJUSTING THE HEIGHT OF THE ANTI-TIPPERS	
10.15	HEADREST KIT AND HEADREST SUPPORT	
10.15.1	INSTALLING A HEADREST SUPPORT	
10.15.2	INSTALLING HEADREST KIT	
10.16	AMPUTEE AXLE PLATE	
10.16.1	INSTALLING AN AMPUTEE AXLE PLATE	
10.17	USING A PARATRANSIT SERVICE	25
11	MOTION COMPOSITES LIMITED WARRANTY	25
12	PARTICULAR DAMAGES	25
12.1	DAMAGE REQUIRING SERVICE	
12.2	SPECIAL DAMAGES THAT REQUIRE THE RETURN OF THE WHEELCHAIR TO THE MANUFACTURER	
12.3	REPAIR PROCEDURE	
13	SAFETY INSPECTION CHECKLIST	26
	WC-19 TRANSIT TIE-DOWNS	27
	DECLARATION OF CONFORMITY	35



3. Product Overview

Parts List

- | | |
|-----------------|------------------------------|
| 1 Push handle | 10 Caster housing |
| 2 Back cane | 11 Wheel lock |
| 3 Arm pad* | 12 Crossbrace |
| 4 Rear wheel | 13 Rear wheel mounting plate |
| 5 Armrest pivot | 14 Seat rail |
| 6 Front rigging | 15 Armrest* or Mud guard |
| 7 Footplate* | 16 Anti-tipper |
| 8 Caster* | |
| 9 Fork | |

* May be different than shown, depending on order configuration.

Helio A7, C2, KIDS, XC2, helio

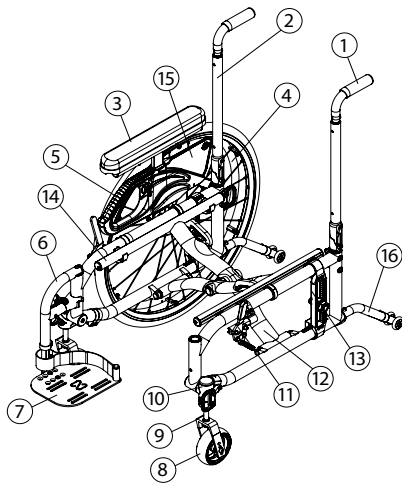

HELIO A6



VELOCE

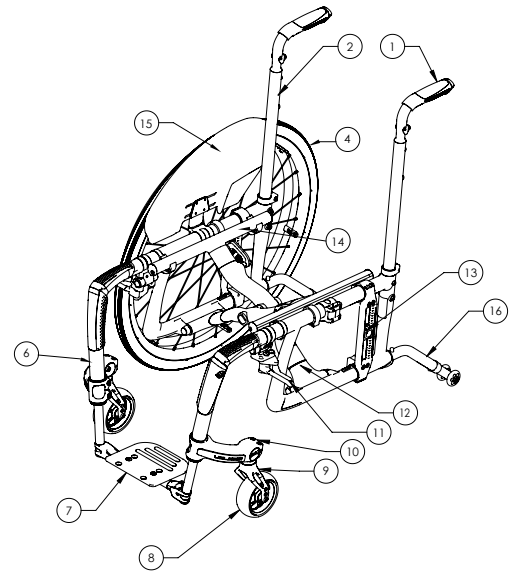

MOVE

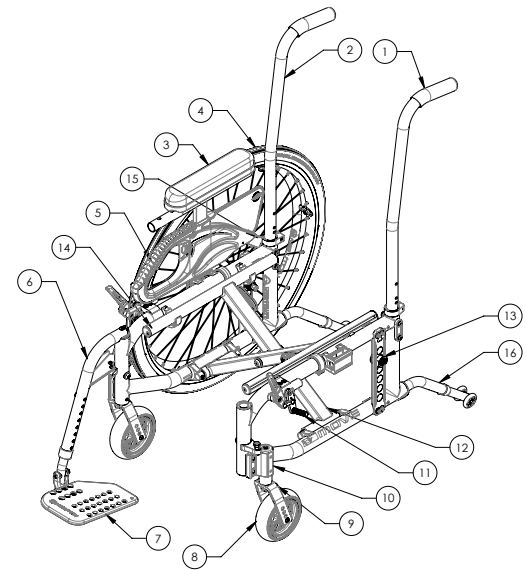



4. Before use

4.1 General WARNING



Your Motion composites wheelchair has been designed by professionals with proper use of aluminum in mind. **DO NOT TRY TO MODIFY** the frame by any means. The frame may be severely damaged in the event of drilling and grinding, thus voiding the warranty. Only use Motion Composites approved and designed clamps and accessories on your Motion composites wheelchair.

DO NOT use while under the influence of alcohol or medication or drugs. This may impair your ability to operate the wheelchair. Please consult your physician regarding the use of your medication.

The wheelchair is not intended for visually impaired people. The user needs to be mentally and physically suitable to drive the wheelchair.



CAUTION

Extreme temperatures

Risk of hypothermia or burns on wheelchair parts. Some parts of the wheelchair can become extremely hot or cold due to extreme temperatures. Do not expose the product to any extreme temperatures (e.g. direct sunlight, sauna, extreme cold) in order to prevent injuries by contact with some parts of the wheelchair.

Environmental conditions

Do not expose the wheelchair to temperatures below -20°C or above 40°C.

4.1.1 Safety Inspections and Maintenance

It is important to keep your wheelchair in proper working condition.

- ALWAYS** inspect and maintain your Motion Composites wheelchair strictly in accordance with the instructions and charts in Chapter 10.4 General Maintenance and Chapter 13 Safety Inspection Checklist.
- If you detect a problem in the course of your inspections or maintenance, **ALWAYS** have the chair serviced or repaired to correct the problem before using the chair.
- ALWAYS** have your wheelchair completely inspected and serviced by an authorized Motion Composite certified technician at least once a year.
- ALWAYS** perform your safety inspections and any maintenance or adjustments while the chair is unoccupied (unless this Manual expressly states otherwise).

4.1.2 Motor Vehicle Safety



WARNING: Identify whether your chair has been manufactured with the Transit Option installed.



If your chair is **NOT** equipped with the Transit Option: The Motion Composites wheelchair is **NOT** designed to be used for seating in a motor vehicle and the wheelchair do **NOT** meet Federal Highway standards for motor vehicle seating.

NEVER sit in your chair while in any type of moving vehicle (bus, automobile, van, truck, boat, train, etc.). In an accident or sudden stop, you may be thrown from the chair. In an accident or sudden stop, a wheelchair seat belt will **NOT** prevent injuries and may, in fact, cause injuries.

ALWAYS transfer to an approved vehicle seat before the vehicle begins moving.

ALWAYS secure yourself in the approved vehicle seat using the proper seating restraints (in a motor vehicle, lap/shoulder belts; in a plane, lap belts, etc.).

NEVER transport your chair in the front seat of a vehicle. Movements of the vehicle may cause the chair to shift and interfere with the driver's ability to control the vehicle.

When transporting your chair in a moving vehicle, **ALWAYS** secure your chair so that it cannot roll or shift. In most cases, stowing it in the trunk is the safest alternative.

NEVER use any chair that has been involved in a motor vehicle accident. A wheelchair that has been involved in a motor vehicle accident may be damaged in ways that are not readily apparent and which could cause the chair to fail in use.

If you ignore these Warnings, you may fall, tip over or lose control of the wheelchair and seriously injure yourself or others or damage the wheelchair.



WARNING: The Motion composites wheelchair is available with a WC-19 Transit Tie-Down. This option is only offered as a factory-installed option. Please refer to the Transit Tie-Down Manual to operate the Transit Tie-Down Option safely.

4.1.3 Acclimating to your new wheelchair



Each wheelchair is a unique piece of medical equipment. Whether you are a new wheelchair user or have years of experience, you **MUST** take the time to acclimate to the wheelchair before you begin riding. Start slowly and take the time to learn the handling, maneuvering and ride characteristics of this chair.

4.1.4 Note to users:

The Motion Composites wheelchair is a manually operated device intended to be used as a means of mobility for persons restricted to a sitting position. It is not indicated for the pediatric population except for the Helio Kids.

Carefully read the instructions in this manual before using or servicing your wheelchair. If you have any questions or difficulties understanding the following instructions, please contact a qualified technician; you may also wish to contact a Motion Composites technician by phone or email (see contact information on previous page).

The Helio Kids wheelchair is a manually operated device intended to be used as a means of mobility for a pediatric population.

4.1.5 Important WARNING when using the stroller-handle and push handles.



The stroller-handle is not designed to lift or pull the weight of user in the wheelchair. It's designed to push and guide the wheelchair user.

Weight limit: 265 lb (120kg)

Lifting or pulling the weight of the user in the wheelchair could initiate the breakage of the push-handle and cause serious injuries.

4.1.6 Note to dealers & qualified technicians

Read this manual before servicing, repairing, operating or adjusting the wheelchair. If you have any questions or difficulties understanding the following instructions, please contact a qualified technician; you may also wish to contact a Motion Composites technician by phone or email (see contact information on previous page).



4.2 Symbols

The following symbols are used throughout this manual. Please familiarize yourself with their meaning.



The warning sign indicates important information to prevent injuries and property damage.



Useful information for the user

Other Warnings and Important Information



Initial setup of your Motion composites wheelchair must be done by a qualified technician.



The latest version of this manual can be found on our website at motioncomposites.com



Regular maintenance of your Motion composites wheelchair will extend the life of the wheelchair. Take your wheelchair to a qualified technician every year for inspection and servicing.



Do not use air or electric tool, tightening should be done manually.

5. Tutorial

To find the latest tutorial or information or contact team at: <http://www.motioncomposites.com/en/team/>

6. Technical Specifications

6.1 Back Upholstery

All Upholstery are made with waterproof material that can be cleaned. Seams are not waterproof. The adjustable tension back upholstery is made of waterproof material. Active-Mesh or Syntech Suede, found on slip-on or semi-tension adjustable back upholstery, can absorb moisture.
Padding: foam
Thickness: 10mm
Compression hardness: 0,231 - 0,258 kPa
Foam volume weight: 32,0 - 33,6 kg/m³
Cover material: Polyester and Nylon antimicrobial, antifungal, Cal-117 Flame resistant

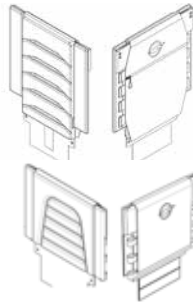

6.1.1 Cushion

All cushions are made of waterproof material that can be cleaned. Seams are not waterproof.
Padding: foam
Thickness: 2 "or 3" / 51 or 76mm
Compression hardness: 0.245 - 0.289 kPa
Foam density: 43.2 - 46.5 kg / m³
Cover Material: Antimicrobial and Antifungal Polyurethane, Fire Resistant Cal-117

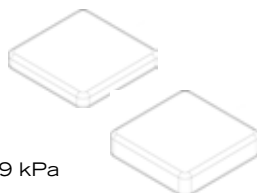

6.1.2 Armrest pad

The armrest is made of waterproof material that can be cleaned.

Padding: foam
Thickness: 26mm
Compression hardness: 0.95 - 0.510 kPa
Foam density: 69.2 - 71.5 kg / m³
Cover Material: Vinyl

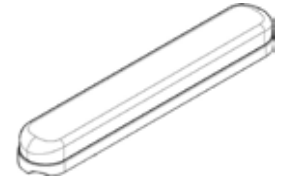

6.2 Label Locations

1. Location on the frame
2. Manufacturer Logo
3. Manufacturer name and address
4. Device name
5. Production year
6. Product description
7. Country of origin
8. Weight limit
9. Serial number and barcode
10. CE standard
11. Read the manual before use
12. Anit-tippers label
13. WC-19 label

Do not remove or alter any labels (Fig 1) on the wheelchair. If the label is damaged, replace it with a new one.

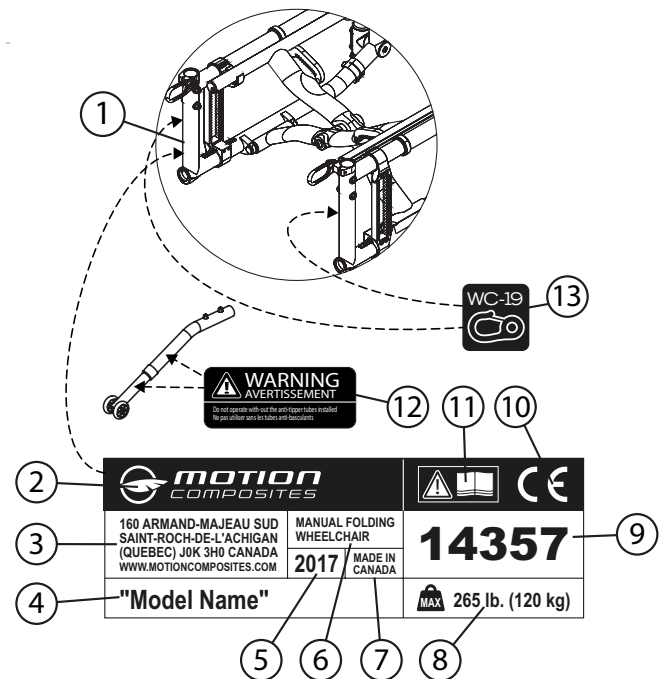

6.3 Structure

Model	Frame	Material	Transport Weight *	Lightest configuration **	STD Capacity	HD Capacity
Veloce	Folding - Molded	T 700 High-Modulus carbon fibre	12 lb - 5,4 kg (including footrest)	19.5 lb - 8,8 kg	265 lb - 120 kg	350 lb - 159 kg
C2	Folding - Molded	T 700 High-Modulus carbon fibre	9.5 lb - 4,3 kg	19.3 lb - 8,8 kg	265 lb - 120 kg	350 lb - 159 kg
Kids	Folding - Molded	T 700 High-Modulus carbon fibre	10.6 lb - 4,8 kg	20.8 lb - 9,4 kg	175 lb - 79 kg	
XC2	Folding - Molded	7005 aluminum / T700 carbon fiber crossbrace	12.4 lb - 5,6 kg	22.2 lb - 10,1 kg	265 lb - 120 kg	350 lb - 159 kg
A7	Folding - Hydroformed	7005 aluminum	13.6 lb - 6,2 kg	23.5 lb - 10,6 kg	265 lb - 120 kg	350 lb - 159 kg
A6	Folding - Hydroformed	6061 aluminum	13.1 lb - 6,0 kg	22.9 lb - 10,4 kg	265 lb - 120 kg	350 lb - 159 kg
Move	Folding - Extruded	6061 aluminum	14.0 lb - 6,4 kg	24.0 lb - 10,9 kg	265 lb - 120 kg	350 lb - 159 kg

* Without rear wheels, cushion, footrests, footplates, armrests, anti-tippers and wheel locks

** With Newton wheel locks, 80° footrests, composites footplates, Newton Gravity rear wheels. Cushion, anti-tippers and armrests/side-guards not included.

6.4 Dimension

Model	Width	Depth	Front seat-to-floor height	Rear seat-to-floor height
Veloce	14 to 20" 35,7 to 50,8 cm	14 to 20" 35,7 to 50,8 cm	14" to 21" 35,6 cm to 53,3 cm	13 1/2" to 20 1/4" 34,3 cm to 51,4 cm
C2	14 to 22" 35,7 to 55,9 cm	14 to 20" 35,7 to 50,8 cm	13" to 21 1/2" 33 cm to 54,6 cm	13 1/2" to 20 1/4" 34,3 cm to 51,4 cm
Kids	12 to 16" 30,5 to 40,6 cm	12 to 19" 30,5 to 48,3 cm	13" to 21 1/2" 33 cm to 54,6 cm	12 1/2" to 19 1/4" 31,8 cm to 48,9 cm
XC2	14 to 22" 35,7 to 55,9 cm	14 to 20" 35,7 to 50,8 cm	13" to 21 1/2" 33 cm to 54,6 cm	12 1/2" to 19 1/4" 31,8 cm to 48,9 cm
A7	14 to 22" 35,7 to 55,9 cm	14 to 20" 35,7 to 50,8 cm	13" to 21 1/2" 33 cm to 54,6 cm	12 1/2" to 20 1/4" 31,8 cm to 51,4 cm
A6	14 to 22" 35,7 to 55,9 cm	14 to 20" 35,7 to 50,8 cm	12" to 20 1/2" 30,5 cm to 52,1 cm	12" to 20 1/4" 30,5 cm to 51,4 cm
Move	14; 16; 18; 20; 22" 35,7; 40,6; 45,7; 50,8; 55,9 cm	16; 18; 20" 40,6; 45,7; 50,8 cm	12 1/2" to 20 1/2" 31,8 cm to 52,1 cm	12 1/4" to 20" 31,1 cm to 50,8 cm

6.5 Adjustability

Model	Upholstery	Back height	Adjustable angle	Footrest	Camber	Centre of gravity
Veloce	Tension adjustable, slide-on or bolt-on	9 to 21" 22,9 to 53,3 cm	85° to 110°	One piece	0°, 3°, 6°	1" to 4" 2,5 cm to 10,2 cm
C2	Tension adjustable, slide-on or bolt-on	9 to 21" 22,9 to 53,3 cm	85° to 110°	Swing in / Swing out	0°, 3°, 6°	1" to 4" 2,5 cm to 10,2 cm + amputee axle plate
Kids	Tension adjustable, slide-on or bolt-on	9 to 21" 22,9 to 53,3 cm	90° to 105°	Swing in / Swing out	0°, 3°, 6°	1" to 4" 2,5 cm to 10,2 cm + amputee axle plate
XC2	Tension adjustable, slide-on or bolt-on	9 to 21" 22,9 to 53,3 cm	70° to 110°	Swing in / Swing out	0°, 3°, 6°	1" to 4 1/2" 2,5 cm to 11,3 cm + amputee axle plate
A7	Tension adjustable, slide-on or bolt-on	9 to 21" 22,9 to 53,3 cm	85° to 110°	Swing in / Swing out	0°, 3°, 6°	1" to 3,75" 2,5 cm to 9,5 cm + amputee axle plate
A6	Tension adjustable, slide-on or bolt-on	9 to 21" 22,9 to 53,3 cm	85° to 110°	Swing in / Swing out	0°, 3°, 6°	0,75" to 2,75" 2 cm to 7 cm + amputee axle plate
Move	Tension adjustable, slide-on or bolt-on	16; 18; 20" 40,6; 45,7; 50,8 cm	90° to 110°	Swing out	0°	0,75" to 2" 2 cm to 5,1 cm + amputee axle plate



7. Safety

7.1 Periodic Checklist

See related appendix (section 13).

7.2 Weight Limitation

The Motion composites wheelchair has a weight limit of 265lb (120kg) and the **HD** model (high capacity) is 350 lb (159kg) with the HD kit. The specified weight capacity include : both the rider and any luggage. For example, a user in a standard wheelchair, 265 lb (120kg), with a 10lb (5kg) backpack, should not exceed a weight of 255 lb (115 kg) . It is of utmost importance that the total weight be below the above specified capacity.

The Helio Kids has a weight limit of 175 lb (79kg).

The wheelchair is designed to support only one person. Please do **NOT** stand up on the footrests.

Motion Composites is not responsible for any damages or injuries caused by the misuse of this wheelchair.

7.3 Weight Training and Sporting Activities

This wheelchair was not designed or tested as a weight training or stretching apparatus. Do not attempt to use this wheelchair for weight training or stretching exercises. The warranty shall be void if the wheelchair has been used for any weight training or stretching purposes.

This wheelchair is not intended to be used during sporting activities. This wheelchair is not intended to be used during sporting activities.



Should you make any adjustments, repairs or do any servicing, ensure that all fasteners are tightly secured before use.



Exceeding the specified weight limit could damage the wheelchair and/or cause severe injuries.



This wheelchair was designed to be tailored to the dimensions of its owner and as such should only be used by its owner unless a qualified specialist, approved by Motion Composites, has readjusted it.

8. Riding your Motion Composites wheelchair



Various adjustments of your wheelchair (seat height/ depth/system, back angle, rear & front wheels camber/ size/position, position of the front riggings) could affect the center of gravity. The adjustments should be performed by a professional and the wheelchair user should be aware that the stability could be affected by these adjustments.



**DO NOT tilt the wheelchair or perform a wheelie without assistance.
DO NOT stand on the wheelchair or part of the frame of the wheelchair.
DO NOT sit or transfer into the wheelchair unless it is fully open and the seat frame rails are fully seated into the receivers.
DO NOT use the footplate as a platform when getting in or out of the wheelchair or to reach for an object.**

8.1.1 To reduce the risk of accident

We recommend that you review safe wheelchair use with your physician prior to using this equipment.

Take the time to read the instructions in this manual to ensure that you feel comfortable using the wheelchair without assistance.

Always be aware of hazards. Unless you are a skilled rider of this wheelchair and that you are sure you are not at risk to tip over, anti-tippers **SHOULD** be used with your wheelchair at all times.

Because anti-tippers are an option in some markets on this wheelchair, Motion Composites strongly recommends to order the anti-tippers as they are an important safeguard for the wheelchair user.

- Always use anti-tippers if you are not a skilled rider.
- Always use anti-tippers each time you modify or adjust your wheelchair. Any change may make it easier to tip backward.
- Use anti-tippers until you adapt to the change, and are sure that you are not at risk to tip over.

8.1.2 Environmental Conditions

The Motion Composites wheelchair was designed to be used on hard and plane surfaces like asphalt, concrete, and indoor hard flooring or carpeting.

- DO NOT** operate on roads, streets or highways.
- Beware that the maneuverability of the wheelchair is significantly affected by different outside conditions such as sand, mud, rain, snow and rough surfaces. If you use your wheelchair in these conditions, it is recommended that you have it frequently serviced. Be careful when using your wheelchair on wet or slippery surfaces. Exposure to water or excessive moisture can be damaging and may even cause the wheelchair to corrode over the long-term.
- DO NOT** leave your wheelchair in humid environments such as the bathroom (e.g. while taking a shower). Store the wheelchair in a dry and cool location. The wheel chair should be stored away from a direct exposure to sunlight. If the wheelchair is wet, dry all parts with a cloth before storing it.
- DO NOT** use your wheelchair in the shower, pool, or other water situations.

8.1.3 Caregivers

- NEVER** use removable parts (e.g. armrests, footrests) to push the wheelchair and never use them to lift the wheelchair occupied since they could cause injuries or damage.
- ENSURE** that the wheelchair is equipped with push handles and that its grips are securely in place.
- Turn anti-tipping devices upwards or remove them to avoid tripping.
- Should you need to leave the wheelchair user unattended, engage the wheel locks and place the anti-tipping devices back in the downward position.
- Ask an experienced caregiver to explain safe assistance methods to you.
- ENSURE** ongoing communication between you and the wheelchair user as to avoid any kind of confusion.
- Maintain proper posture to tilt or lift the wheelchair; keep your back straight and bend at the knees.
- Instruct the wheelchair user to lean his/her back when you are tilting the wheelchair.



8.2 Riding your wheelchair

8.2.0 In order to reduce the risk of a tip-over, you should:

1. **CONSULT** your doctor, nurse or therapist to find out what axle and caster position and other chair configuration options are best for you.
2. **CONSULT** your authorized Motion Composites dealer **BEFORE** you modify or adjust your wheelchair. Often, an adjustment you wish to make can be offset by another that you have not considered. For example, you may want to adjust the back angle rearward, which will increase the likelihood of a rear tip-over. You might not think you could counteract this tendency by moving the rear wheels backward. Your authorized Motion Composites dealer will be able to give you expert, personalized advice in such matters.
3. **ALWAYS** have someone assist you until you learn your chair's balance points and are completely comfortable in your ability to operate your chair under all conditions so as to avoid tip-overs.
4. **ALWAYS** use both anti-tippers.

If you ignore these Warnings, you may fall, tip over or lose control of the wheelchair and seriously injure yourself or others or damage the wheelchair.

8.2.1 Balance point

It is important to begin by learning all of the specific characteristics of your wheelchair. Ask a health professional to explain them to you. Carrying a backpack will affect the balance point of your wheelchair. Be aware of resulting handling factors in relation to your body position, posture or weight distribution. The center of gravity is affected by the angle of the wheelchair on a ramp or slope. This can be felt in forward and backward as well as side to side movements. Make sure to review the different riding techniques prior to using the wheelchair. Use anti-tippers until you are skilled at riding your wheelchair in any situation.

8.2.2 Wheelies

DO NOT attempt to perform a wheelie in your wheelchair because of the dangerous nature of this kind of maneuver. Motion Composites recognizes that some wheelchair users will ignore this Warning. If you should choose to ignore this Warning, you should follow these steps to help learn to do a "wheelie" as safely as possible.



NEVER attempt to learn to do a wheelie without first consulting your health care advisor. **NEVER** attempt to learn to do a wheelie without an assistant that can catch you if you should happen to start to fall. **NEVER** attempt to learn to do a wheelie unless you are a skilled rider on this chair. Motion Composites always recommend using both anti-tippers at all-time unless they need to be removed to go up or down a curb/step. Both anti-tippers should be reinstalled once the curb/step is cleared.

8.2.3 Transferring

Rotate the front casters forward to enhance stability.

Place the wheelchair as close to your transfer location as possible. Engage wheel locks. Position yourself as far back as possible when transferring weight to reduce risk of tipping forward. If you have good upper body strength, balance and agility, you may be able to perform transfers independently. Rotate or remove footrests if at all possible as to avoid putting weight on them. If possible, make use of a transfer board.



Always ask a healthcare provider to learn safe transfer methods.

DO NOT sit or transfer into the wheelchair unless it is fully open and the seat frame rails are fully seated into the receivers.

DO NOT use the footplate as a platform when getting in or out of the wheelchair or to reach for an object.

8.2.4 Getting Dressed

When dressing or undressing on the wheelchair, rotate the front casters forward and lock anti-tippers in the lower position. If your wheelchair is not equipped with anti-tippers, back it against a wall and lock the rear wheels.

8.2.5 Reaching/Leaning/Bending



The balance point may shift when you are putting on clothes and/or reaching for objects while sitting in the wheelchair.

If at all possible, use a reaching device or ask for assistance when reaching for objects.

Move the wheelchair as close as possible to the required object.

Rotate the casters as far forward as possible from the rear wheels.

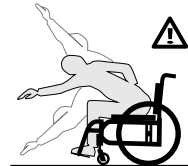

NEVER reach for objects between your legs, but rather position yourself to the side of these objects.

DO NOT shift your weight sideways, but rather rise up from the seat or move forward in the seat. Always use both hands and grab the opposite side wheel or armrest if you are capable of reaching sideways. Never reach to the rear of the wheelchair unless it is equipped with anti-tippers. Never reach for objects over the seat back: reach only as far as your arm naturally extends without moving on the seat.

DO NOT lock the rear wheels if you are reaching backwards. Avoid putting pressure on the footrests.



8.2.6 Moving backwards

Lock both anti-tippers in lower position. Move slowly: the wheelchair is designed to provide you with more stability when moving forward. Look around as often as possible to avoid obstacles in your path.



8.2.7 Ramps, Slopes & Side Hills

Ramps of 10 feet (3 meters) or less in length

If you need to use a short ramp 10 feet (3 meters) or less, the angle of the slope should not exceed 10 degrees, which corresponds to a slope of 17.63%, a rise of 1.74 feet (0.53 meters) over a distance of 10 feet (3 meters).

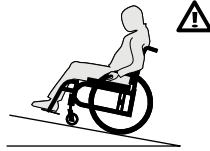

Make sure to be assisted by a caregiver who has the physical ability to retain the wheelchair and its occupant. The wheelchair must always point facing up the slope.

The caregiver should always remain in the bottom of the slope to retain the wheelchair.

Always lock the anti-tip in the safe position.

Follow the same words of caution for a hill or a slope of 10% or less.

Do not use your wheelchair on a ramp under 3 meters in length if the slope angle is greater than 10 degrees (17.63%)

Ramps of 10 feet (3 meters) or more in length

If you must go through a slope or a vertical rise of 10 feet (3 meters) or more, the angle of the slope should not exceed 5.7 degrees, which corresponds to a 10% slope is a rise of 1 meter for a distance of 10 meters.

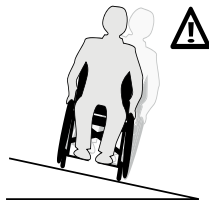

Make sure to be assisted by a caregiver if you have trouble on the slope or if the slope is between 5.7 and 10 degrees.

Try to move straight up or down the slope. Avoid turning on a downhill slope.

Stay in the center of sidewalks and ensure that there is enough space for the wheels.

Avoid stopping on slopes and never use the wheel locks to slow yourself on a downhill slope. Maintain your speed by holding the hand rims.

Do not ride on wet or slippery surfaces. Be cautious for changes in terrain height or stairs at the end of a slope (front casters may lock from simply hitting a small bump).

Ask for help should any situations arise.

Incline yourself while moving down a slope as to adjust your center of gravity.

Do not use your wheelchair on your own on slopes or hill of more than 10 feet (3 meters) in length if the angle of the slope is greater than 5.7 degrees (10%).

8.2.8 Obstacles

Always look for obstacles or road hazards (potholes, broken surfaces, etc.). Clear your own environment (work, home) of any obstacles. Never use objects (furniture, ramps, and doorknobs) to push yourself out of the wheelchair.

Lean your upper body slightly forward as you move up an obstacle. Do the reverse while moving down an obstacle. Keep both hands on the hand rims while passing over the obstacle.

8.2.9 Curbs and Steps



Curbs and steps are extremely dangerous obstacles.

NEVER attempt to go up or down a single curb or step without an assistant unless you are a very skilled rider of your chair. You need to have previously learned to safely do a wheelie in your chair and you are sure you have the strength and balance to control your chair during any such maneuver.



ALWAYS unlock and rotate anti-tippers up and out of the way so they do not prevent you from executing this maneuver.

NEVER attempt to climb or descend a curb or step more than 4" high.

ALWAYS go straight up or down a curb or step. **NEVER** climb or descend at an angle.

ALWAYS be aware that the impact of dropping down from a curb or step can damage your chair or cause components to become loose. If you perform such maneuvers, inspect your chair more frequently. **ALWAYS** Rotate and lock the anti-tippers back to ride safely.

8.2.10 Moving with Assistance

Caregivers should read the "Caregiver" section of this manual. SECTION 8.1.3

8.2.10.1 Climbing a curb or single step



1. **NEVER** attempt to negotiate a curb or single step without assistance.

2. Instruct your assistant to stand at the rear of your wheelchair, with the front of the wheelchair facing the obstacle.

3. **NEVER** attempt to negotiate any such obstacle backward.

4. Instruct your assistant to tilt the chair up on the rear wheels so that the front casters clear the curb or step.

5. Instruct your assistant to slowly move the chair forward and to gently lower the casters to the upper level as soon as you are sure that they are beyond the edge of the curb or step.

6. Instruct your assistant to continue to roll the chair forward until the rear wheels contact the face of the curb or step.

7. Instruct your assistant to lift and roll the rear wheels up to the upper level.

8. Instruct your assistant to never attempt to completely lift the wheelchair with the push-handles.

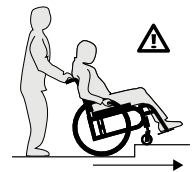

8.2.10.2 Descending a curb or single step



1. **NEVER** attempt to negotiate a curb or single step without assistance.

2. When you are still several feet or a couple of meters from the edge of the curb or step, instruct your assistant to stand at the rear of your wheelchair and turn it around so you are facing away from the curb.

3. **NEVER** attempt to negotiate any curb or similar obstacle facing forward.

4. Instruct the assistant to carefully step backwards, pulling the wheelchair backwards, until he or she is off the curb or single stair and standing on the lower level. The assistant should watch his or her step over his or her shoulder when backing up in this manner.

5. Instruct the assistant to carefully pull the wheelchair backward until the rear wheels reach the edge of the curb or step, and to then allow the rear wheels to slowly roll down to the lower level.

6. Instruct the assistant that, when the rear wheels are safely on the lower level, he or she may then tilt the chair backward to the balance point of the rear wheels, thereby raising the casters off the upper level.

7. Instruct the assistant to slowly roll the wheelchair backward on the rear wheels, taking small steps until the casters have cleared the step or curb and, when clear, to gently lower the casters to the ground at the lower level.

8. Instruct your assistant to never attempt to completely lift the wheelchair with the push-handles

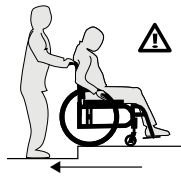

8.2.11 Stairs

Use an elevator wherever possible.

Ask for help from two people to move the wheelchair up or down stairs (the caregivers should read the "Caregiver" section of this manual).

Fasten your seat belt when being lifted in the wheelchair.

The assistants should always grab the frame of the wheelchair to lift you in the wheelchair. **NEVER** grab the push-handles, back-canes, wheels, footrest or any moving parts to lift the wheelchair

8.2.12 Climbing a flight of stairs



WARNING - DO NOT CLIMB a flight of stairs with the user in the wheelchair.

Motion Composites recognizes that wheelchair users may, on occasion, have no other choice and will need to be moved up or down a flight of stairs or will need to be lifted. **Only when there is no other alternative, care givers and wheelchair users should follow these steps to climb a flight of stairs.**

1. **NEVER** attempt to negotiate more than one step unless you have two (2) able adult assistants.

2. **ALWAYS** position the wheelchair and user facing away from the stairs, with one assistant at the rear (facing away from the stairs) and one at the front of the wheelchair (facing the user).

3. The assistant at the rear of the wheelchair is in control and know how to climb a flight of stairs. He or she must tilt the wheelchair back to find its balance point on the rear wheels.

4. **NEVER** attempt to lift a wheelchair by lifting on any removable (detachable) parts, including upholstery, removable push handles or push handle grips.

5. **ALWAYS** hold the wheelchair from a solid part of the frame.

6. The second assistant at the front must firmly grip the frame (NOT the footrest or footplate) with both hands and lift the wheelchair up and over one stair at a time.

7. Each assistant then carefully moves up to the next stair.

8. Repeat steps 1 through 6 for each stair, until you reach the top of the stairs.

9. When you reach the top of the stairs, the assistants should roll the wheelchair backward on the two rear wheels until the casters have cleared the last step, at which point the assistants can gently lower the casters on the floor.

10. The assistants should always grab the frame of the wheelchair to lift you in the wheelchair. **NEVER** grab the push-handles, back-canes, wheels, footrest or any moving parts to lift the wheelchair.

8.2.13 Descending a flight of stairs warning



DO NOT DESCEND a flight of stairs with the user in the wheelchair.

Motion Composites recognizes that wheelchair users may, on occasion, have no other choice and will need to be moved up or down a flight of stairs. **Only when there is no other alternative, care givers and wheelchair users should follow these steps to descend a flight of stairs.**

1. **NEVER** attempt to negotiate more than one step unless you have two (2) able adult assistants.

2. **ALWAYS** position the wheelchair and user facing down from the stairs, with one assistant at the rear (facing down from the stairs) and one at the front of the wheelchair (facing the user).

3. The assistant at the front of the wheelchair is in control and know how to descend a flight of stairs. The person at the rear must tilt the wheelchair back to find its balance point on the rear wheels.

4. **NEVER** attempt to lift a wheelchair by lifting on any removable (detachable) parts, including upholstery, removable push handles or push handle grips.

5. **ALWAYS** hold the wheelchair from a solid part of the frame.

6. The assistant at the front must firmly grip the frame (NOT the footrest or footplate) with both hands and lift the wheelchair over one stair at a time.

7. Each assistant then carefully moves down to the next stair.

8. Repeat steps 1 through 6 for each stair, until you reach the bottom of the stairs.

9. When you reach the bottom of the stairs, the assistants should move the wheelchair forward until the two rear wheels clears the last step, at which point the assistants can gently lower the casters and back wheels on the floor.

10. The assistants should always grab the frame of the wheelchair to lift you in the wheelchair. **NEVER** grab the push-handles, back-canes, wheels, footrest or any moving parts to lift the wheelchair.

If you ignore these warnings, you may fall, tip over or lose control of the wheelchair and seriously injure yourself or other people and or damage the wheelchair.

8.2.14 Escalators

Under no circumstances should this wheelchair be used on an escalator, not even with the help of an attendant. This could cause severe injuries.

9. How to use your Motion Composites wheelchair

9.1 Folding & Unfolding

9.1.1 Folding

- Rotate front riggings forward until they lock in position.
- Flip up the footplates.
- Remove the seat cushion.
- Lift the handle on the seat upholstery (Fig. 2).
- Pull the wheels towards each other.

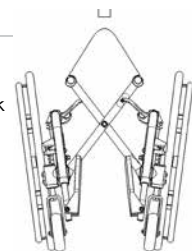

Fig. 2



9.1.2 Unfolding



When unfolding the wheelchair, be careful not to put your fingers between the pivot links, or under the seat rails. Always push or pull on the seat upholstery. Make sure the wheelchair is fully opened before transferring or sitting.

- Tilt the wheelchair towards you; make sure the opposite wheels are off the ground.
- Push the edge of the seat upholstery towards you until it closes properly.
- Press downwards on both seat rails in order to engage the lock mechanism of the wheelchair. It is necessary to push down on the middle of the seat rails to make sure that they are correctly positioned in the seat rail supports. You will feel a click between frame components.

9.2 Wheel Locks



Never use wheel locks to stop wheelchair movement. **WHEEL LOCKS ARE NOT BRAKES.** Make sure the surface is not slippery as the wheelchair could move even though the wheel locks are engaged.



Ensure that the stem locks imbed at least 1/8" (0.3 cm) into the tire rubber when chair is in locked position. Tire must be inflated properly.

Ensure the wheelchair is stable and locked with wheel locks.

- To engage the locks (Fig. 3), push wheel lock handle forward (for push-to-lock type) or pull wheel lock backward (for pull-to-lock type) until the lock is fully engaged.
- To release the locks, pull wheel lock handle backward (for push-to-lock type) or push wheel lock handle forward (for pull-to-lock type) until the lock is fully disengaged.

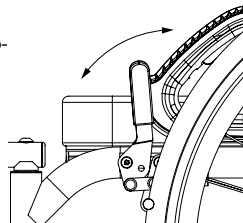

Fig. 3

9.3 Front Riggings

9.3.1 Installing and removing

Installing (except Veloce)

- Insert the front rigging pivot into the wheelchair's mounting tube (Fig. 4b)
- Rotate the assembly toward the front until the mechanism locks into place.
- Repeat the same steps for the other side.

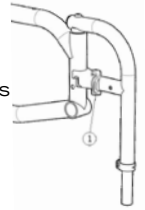

Fig. 4b

Removing (except Veloce)

- Push the release locking lever (1) (Fig. 4a) inward or outward and maintain that position so the front riggings can rotate freely.
- Rotate front riggings outwards or inwards to disengage the locking mechanism.
- Lift the assembly up (Fig. 4b) so as to disconnect it from the wheelchair's frame.
- Repeat this procedure for the other side.

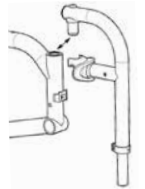

Fig. 4a

Opening and closing the Veloce footrest

- The Veloce is equipped with a flip-up or Auto-folding footplate (fig, 4d)
- The Auto-folding footplate opens and closes automatically when the wheelchair folds and unfolds.
- The single Flip-up model (fig, 4c) can be opened and closed the following way
- Rotate the ring (1) to unlock and open the locking mechanism
- Lift (2) the foot plate to open
- When closing make sure to secure the shaft head in the locking mechanism
- Make sure the footplate is secure once closed

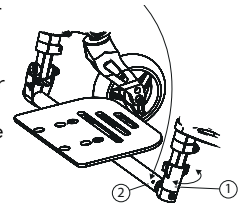

Fig. 4c

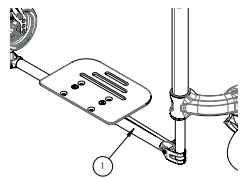

Fig. 4d

9.4 Footrest

- When transferring, avoid putting weight on the footrest and be careful not to stand behind the footrest.
- Never use footplates to lift the wheelchair.
- Only use non-detachable parts to lift the wheelchair.

9.4.1 Elevating legrest (not available on Veloce)

9.4.1.1 Installing the elevating legrest

- Remove the actual footrest, see section 9.3.2
- Install the elevating legrest (Fig. 4.1) the same way to install a regular front rigging, see section 9.3.1.

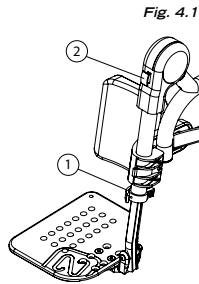

9.4.1.2 Adjusting the elevating legrest

- To change the legrest length, pull on the lever (1) to open the clamp
- Change the length and push on the lever (1) to close the clamp.
- To change the legrest angle, set the desired angle while pushing on the red button (2).

9.5 Armrests



Ensure that armrests are securely locked into arm sockets and armrest release buttons are locked into place prior to using the wheelchair.

- Never lift the wheelchair by holding the armrests.
- Use only non-detachable parts for lifting.

9.5.1 Flip-back armrests

To lift the armrests (Fig. 5):

- Pull lever (1) upwards to release the system.
- Rotate the armrest all the way up and down.

To reinstall the armrests in closed position:

- Rotate the armrests downward until the front slide plate enters in the armrest receiver and snaps into place.
- Make sure the locking lever is engaged to avoid any movement.

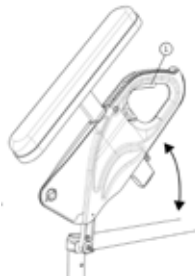

Fig. 5

9.5.2 Removable T armrests

To remove the armrests:

- Pull lever (1) (Fig. 6) upwards to release the system.
- Pull the armrest all the way up.

To reinstall the armrests:

- Bring the armrests downward until the slide (2) enters in the armrest receiver (3) and snaps into place.
- Make sure locking lever is engaged to avoid any movement.

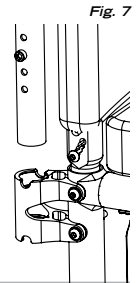

Fig. 6

9.5.3 Swing-Away Armrests

To remove the armrests from the wheelchair (Fig. 7):

- Lift them straight up to release the armrest.
- To reinstall the armrests, insert them back in the armrest receiver (1) until they set into place.



9.6 Seat belts



Use positioning belts **ONLY** to help support the rider's posture. Improper use of these belts may cause severe injuries to the rider.



Make sure the rider does not slide down in the wheelchair seat. If this occurs, the rider may suffer chest compression or suffocate due to pressure from the belts.



Never use belts as a motor vehicle restraint.

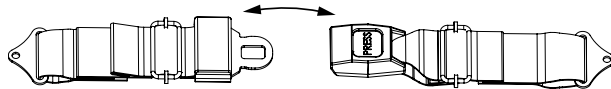

- The seatbelt should be used at all times in accordance with instructions.
- There should be approximately one hand width of space between the seat belt and thigh; do not exceed this amount of space.
- Ensure that the seat belt is properly fastened as to avoid serious injuries.
- In case of emergency, ensure that seat belt can be easily unfastened.

9.6.1 Auto buckle and aircraft buckle seatbelts

- To fasten your seatbelt, insert the clip into the buckle until it snaps.
- Make sure the belt is securely fastened.
- To unfasten your seat belt, lift the flap on the aircraft buckle seatbelt or push the button on the auto buckle seatbelt.
- To adjust your seat belt, pull each strap towards the opposite side until you get the desired tension and keep the buckle centered.

9.6.2 Velcro Belt

- To fasten your seatbelt, insert the long side of the seatbelt into the buckle on the other side.
- Apply pressure on the belt for a firm grip of the velcro.



9.7 Anti-Tippers



WARNING Motion Composites strongly recommends the use both anti-tippers

Anti-tippers (Fig. 8) were designed to prevent falls from the wheelchair.

- To remove or rotate the anti-tippers up, push the release button (1) and pull out or rotate the anti-tippers (2).
- To replace the anti-tippers, press the release button and insert them into the frame until they snap into position.
- Highest Curb Clearance: 1 1/2" to 2", depending on configuration



Fig. 8



Anti-tippers should not be used as a tipping-aid. Always install both anti-tippers

9.7.1 Tipping-aid Lever



Motion Composites Tipping-aid Lever should not be used with the anti-tippers.

To install or remove the tipping lever, push the release button (1) and push in or pull out the tipping lever (2). When inserting the tipping lever, the push button should snap in position into the frame

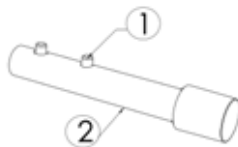

Fig. 8.1

The tipping lever should be removed when installing the anti-tippers

9.8 Rear Wheels Axles

9.8.1 Quick-release axles



WARNING Stainless quick-release axles are a standard wheelchair component. Other axle types are optional equipment. All quick-release axles are designed to make your rear wheels easy to remove quickly. However, if not used properly, they can be dangerous.

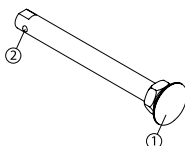

Fig. 9



NEVER use your chair **UNLESS** you are sure that both rear axles are locked into place in the axle receiver. If an axle is not fully locked into place, the rear wheel may come off during use of the chair and cause you to fall. You can notice when the axle is locked into place because the quick-release button in the center of the axle will pop out fully. It is also a good idea to pull on the wheel to double-check that the axle is securely locked as a final precaution.

- To remove the rear wheels, push the button in the center of the wheel's hub (Fig. 9) and pull the wheels off (1).
- To reinstall the rear wheels on the wheelchair, push the button of the quick-release axles, insert the axle into the wheelchair axle bushing and release the button
- Always make sure that the quick release detent balls (2) extend beyond the axle bushing for a secure lock.

9.8.2 Fixed axles

- To remove the rear wheels: unscrew the bolt (1) (Fig. 10) located inside the wheelchair axle bushing and pull out the wheel.
- To reinstall the rear wheels on the wheelchair: insert the threaded axles (2) in the axle bushing.
- Tighten the bolt (1) and make sure that the wheel is still turning without any restrictions.

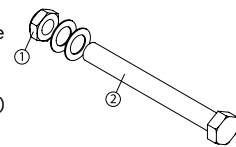

Fig. 10

9.8.3 One arm drive System

Utilization

To propel the wheelchair in a straight line, grasp the two handrims in one hand to push or pull in the desired direction. To slow down the wheelchair, simultaneously press on the two handrims with one hand to create friction.

To turn the wheelchair, exert pressure or create friction on one of the two driving handrims.

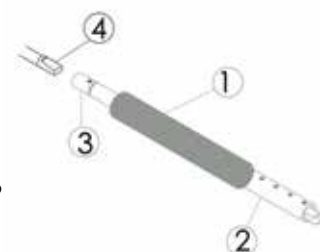

Fig. 10.1

To fold the wheelchair

Grip the handle (1) and compress the drive shaft (2) on the mounting plate to clear the opposite side of the shaft. Remove the drive shaft from the wheelchair and fold it as needed

To install the One arm drive system

Insert the end of the drive shaft (3) on the mounting plate axle (4).

Compress the drive shaft and insert the other side of the shaft onto the mounting plate axle on the opposite side.

Make sure the axle is secure before using the wheelchair.

Specifications

Weight limit 265 lbs / 120 kg

The rear wheels remain attached to the wheelchair.

9.9 Seat slings

- Seat slings are not intended to be used as a seating surface. Always use a cushion.
- Ensure that the sling is in good condition (e.g. no fraying, no wear and no tears).

9.10 Push Handles

Push handles are optional equipment on some Motion Composites wheelchairs. Push handles provide secure points for an attendant or assistant to hold the rear of the wheelchair to prevent a fall or tip-over. If you have an attendant or assistant, you should have push handles installed on your wheelchair by Motion Composites or a certified Motion Composites dealer.

Motion Composites offers push handles that are integrated to the back canes or bolt-on push handles. Motion Composites recommends that you do NOT use non-Motion Composites bolt-on push handles because they could damage the backrest or the back canes of the Motion Composites wheelchair.

Your attendant or assistant should regularly check the push handle grips to make sure they fit securely and will not rotate or slip off.

Push handles should **NEVER** be used to lift the wheelchair or pull the chair, especially when it is occupied, as they may detach.

ALWAYS lift or pull the wheelchair by grasping a non-detachable part of the frame (not the detachable handles, backrest, armrest or footrest).

If you fail to observe these warnings damage to the chair, a fall, tip-over or loss of control may occur and cause severe injury to the wheelchair user, the assistant or others people.

9.10.1 Fold-down push handles

Folding instructions:

- To fold or open push handle press on button (1) to engage the folding mechanism. (Fig 10.2).

Weight limit 265 lb / 120 kg.

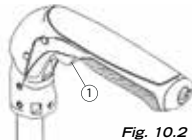

Fig. 10.2

NEVER use the fold-down push handles to lift the wheelchair or pull the chair, especially when it is occupied, as they may detach

9.10.2 Adjustable height push handles

Adjustment instructions:

- To adjust the height of the push handles pull on the lever (1) to open the clamp (Fig. 10.3).
- Set the height and push the lever (1) to close the clamp.

Weight limit 265 lb / 120 kg

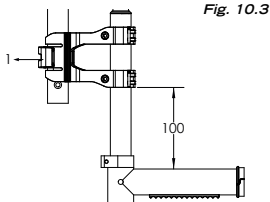

Fig. 10.3

NEVER use the adjustable height push handles to lift the wheelchair or pull the chair, especially when it is occupied, as they may detach

i The position of the clamp on the back canes should not be changed. The distance between the clamp of the adjustable push handle and the clamp of the back canes should not exceed 100mm.

10. Adjustments and maintenance of your Motion Composites wheelchair

10.1 Service

Refer to your dealer for service. A complete and updated list of service providers can be found on our website.

10.2 Replacement Parts

Ordering information:

Consult our website to download the parts manual and view ordering information.

Please contact us at:

Motion Composites Inc.
160, Armand-Majeau Sud
Saint-Roch-de-l'Achigan, Quebec
J0K 3H0 Canada
Phone: 1-866-650-6555
Fax: 1-888-966-6555
support@motioncomposites.com
www.motioncomposites.com

10.3 Tools needed



The Motion composites wheelchair was designed to be serviced with regular tools. All screws and bolts are standard and can be adjusted with a wrench, socket wrench, or Allen key. Do not use air or electric tool, tightening should be done manually.

The list of tools is at the end of this manual.

10.4 General maintenance

10.4.1 Tire pressure

- Check tire pressure with a tire gauge.
- Verify recommended tire pressure, which is indicated on the tire.
- Inflate if pressure is below recommended amount as labelled on the sidewall.
- Do not inflate tire over recommended pressure, as stated on the tire.
- Over inflation could result in tire failure and injury.
- Under inflation could result in a flat tire.

Max pressure

Pneumatic	1 3/8"	65 psi
Pneumatic High pressure	1 1/4 and 1 3/8"	110 psi
Pneumatic High pressure	1"	145 psi

10.4.1.1 Puncture

In the event of a puncture, consult an appropriate workshop (either a bike repair center or wheelchair repair center) to repair or replace the tube by a qualified person.

10.4.2 Cleaning your wheelchair

- Use a soft clean cloth with soap and water to clean your wheelchair.
- Rinse and dry the wheelchair adequately.
- **DO NOT** use solvent cleaners.
- **DO NOT** use abrasive cleaners.
- **DO NOT** use a pressure cleaner.

Paint Finish and frame

- Clean the painted surfaces with mild soap at least once a month.
- Protect the paint with a coat of non-abrasive auto wax every three months.

Axles and Moving Parts

- Clean around axles and moving parts WEEKLY with a slightly damp cloth.
- Wipe off dust or dirt on axles or moving parts.

Upholstery:

- Hand-wash only (machine washing may damage fabric).
- Hang to dry only. **DO NOT** machine dry as heat will damage fabric.

10.4.3 Storing and shipping your wheelchair

When not in use, keep your chair in a clean, dry area. Failure to do so may result in your chair rusting and/or corroding.

If your chair has been in storage for more than a few weeks you should make sure it is working properly. You should inspect and service, if necessary, all items in section 13 Safety Inspection Checklist.

If your chair has been in storage for more than two months, it



should be inspected by a qualified technician. When shipping your wheelchair use a strong cardboard box to protect the wheelchair from any impact. Inspect the wheelchair once it's received.

10.5 Backrest

10.5.1 Removing/Installing the Back Canes

- Loosen the top bolts (1) (Fig. 11) and (2), which are also used to support the armrest socket (Swing Away and Flip Back armrest).
- Slide the back post to remove it from the tube.
- Reinstall the back post in the reverse order and tighten screws snugly.
- Tighten bolts (1) and (2) firmly.
- Wheelchairs equipped with Flip Back armrests; tighten screw (1) while paying special attention to the force needed to flip back the armrest.

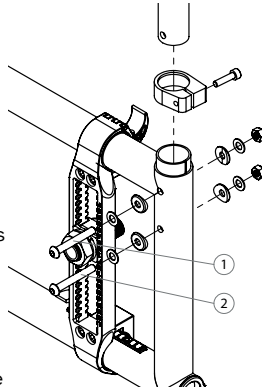

Fig. 11

10.5.1.1 Depth Adjustable option

- Loosen screw (1&2) (Fig. 11.1), which are also used to support the armrest socket (Flip Back armrest).
- Reinstall the back post in the reverse order and tighten screws snugly.
- Tighten bolts and firmly.



Warning - Weight Limit 175 lb (79 kg) and not WC-19 compatible

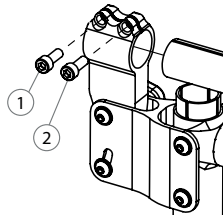

Fig. 11.1

10.5.2 Adjusting the Back Angle

- Loosen screw (1) (Fig. 12) and remove screw (2) from the levelling device.
- Adjust to desired angle by sliding the mechanism.
- Reinstall screw (2) and tighten both screws to fit snugly.
- Settings: 5° increments from 85 to 110° (Kids 90 to 105°)

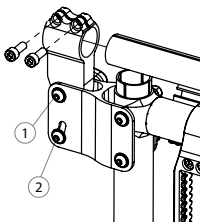

Fig. 12

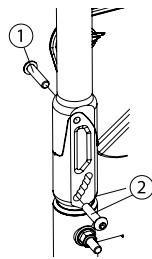

Fig. 12b

10.5.3 Removing/Installing the seat belt

- Remove Screw (1) in order to remove the seat belt clamp (2) that is attached to the belt. (Fig. 13)
- Reinstall screw (1) directly on the frame clamp (3) (Fig. 14)
- Tighten screw (1) until it is properly tightened.
- Repeat the same steps on the other side

Fig. 13

Fig. 14

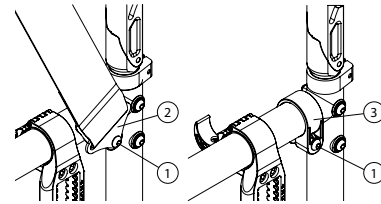

10.5.4 Adjusting the Backrest Height

- Loosen the screw (1) (Fig. 15) that holds the back upholstery.
- Pull backrest upholstery down several centimeters in order to access screw (2) that holds the push handle.
- Remove screw (2) and the backrest handle.
- To adjust the backrest height, with the help of a threaded rod ($\frac{1}{4}$ "-20), move the dowel nut (3), which is located inside the handle.
- Once this step is completed, use screw (2) to hold the dowel nut (3) while removing the threaded rod.
- Remove screw (2) and reinstall backrest handle.
- Align screw (2) with the mounting hole.
- Reinstall and tighten screw (2) and the washer.
- Repeat the same steps on the other side.
- Reinstall the backrest upholstery with screw (1) and tighten to fit snugly.

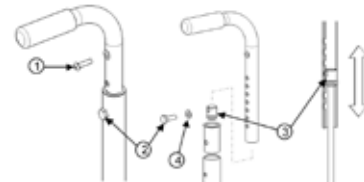

Fig. 15

10.5.4.1 Adjusting the Backrest Height (Integrated push handle)

- The backrest with integrated push handles can be adjusted by loosening bolt 1 and removing the bolt 2 on each side of the frame.
- Move the back canes up or down to the desired height.
- Handles and back upholstery will be adjusted accordingly.

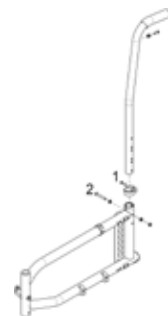

Fig. 15a

10.5.5 Installing/Removing Standard Back Upholstery

- Remove screw (1) (Fig. 16) that holds the back upholstery.
- Pull backrest upholstery down several centimeters to gain access to screw (2), which holds the push handle.
- Remove screw (2) and then remove the backrest handle.
- Remove or install back upholstery.
- Once, the new back upholstery is installed, reinstall the handles by aligning them with the mounting holes.
- Reinstall and tighten screw (2) firmly.
- Install back upholstery at and fix it firmly with screw (1) on each back cane.

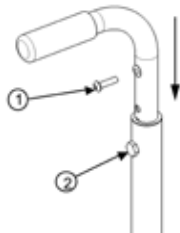

Fig. 16

10.5.5.1 Installing/Removing Back Upholstery (Integrated push handle back canes)

- Remove screw (1) (Fig. 16a) that holds the back upholstery.
- Remove the bolts (2) on each side of the frame and remove the back canes.
- Remove or install back upholstery.
- Reinstall and tighten screw (2) firmly.
- Install back upholstery at and fix it firmly with screw (1) on each back cane.

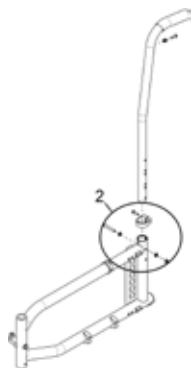
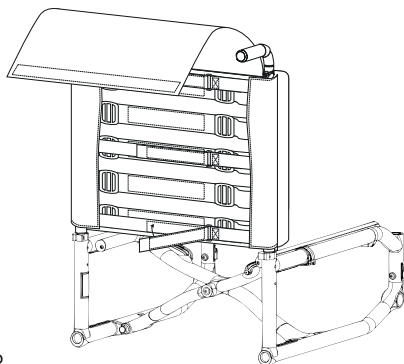

Fig. 16a

10.5.6 Installing/Removing Adjustable Tension Back Upholstery

- To remove the adjustable Tension Back Upholstery, use the same steps as the standard back upholstery. Lift the back cover to have access to the 2 bolts to remove the upholstery.
- To adjust the tension, first lift the back-cover flap to expose the horizontal straps (a). Release the Velcro straps, then adjust each strap individually using the Velcro or the buckle tension adjustment system to the desired tension.



ATTENTION - AVOID over-tightening of the strap assembly as this may cause damage to the integrity of the back canes. Lastly, fold down the back-cover flap over the horizontal adjustment straps to complete your adjustment.

10.6 Armrest

10.6.1 Installing Flip-back Armrests

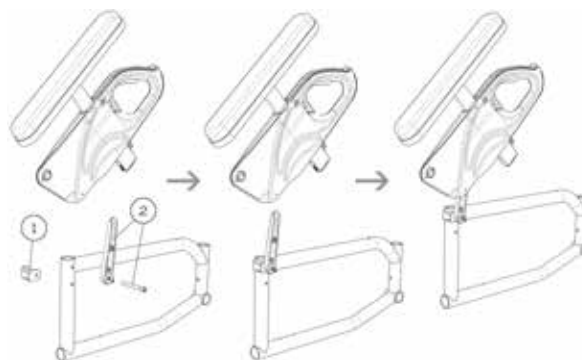

Fig. 17a

Fig. 17b

Fig. 17c

- Insert the flip-back pivot (1, 2) (Fig. 17a) and screw it in place, making sure it stays in place but can rotate easily.
- Insert the armrest (Fig. 17b) on the flipback pivot than rotate it until it clicks with the armrest receiver (Fig. 17c) (for clamp installation, see 10.6.3 installing removable T-armrests).

10.6.2 Adjusting the height of Flip-back and T armrests

- Flip lever (1) left or right to unlock the armrest (Fig. 18).
- To adjust height, slide the upper part of the armrest into the lower part.
- Adjust the structure (2) at the desired height.
- Flip the lever back to the closed position.
- Make sure the armrest clicks in place for complete securement.

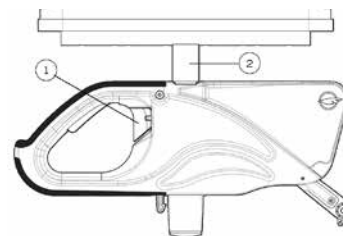

Fig. 18

10.6.3 Installing removable T-armrests and rigid sideguard

- Install armrest receiver (1) (Fig. 19) on the upper tube of the frame at a distance of 160mm (6 1/4") from the rear tube of the frame.
- Slightly tighten screws (2) to allow the clamp to rotate.
- Insert armrest or sideguard into receiver (1).
- Rotate receiver (1) until the sideguard is perpendicular to the seat.
- Tighten screws (2) firmly.

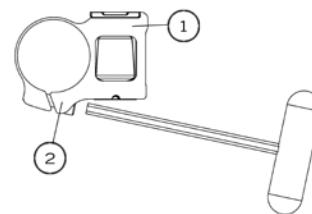
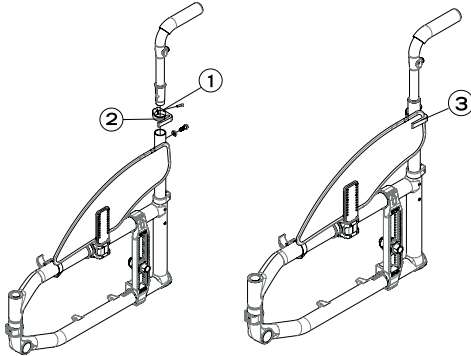

Fig. 19



10.6.3.1 Installing the sideguard clamps

- Open the clamp (1) to install it around the back cane so that the finger (2) is parallel to the rear wheels.
- Be sure to place the clamp as high as possible without exceeding the clothes guard (3), making sure that it is inserted as far into the finger as possible.
- Once in place, secure the clamp by firmly tightening the screw.



10.6.4 Replacing Armrest Pad

- Remove screws (1) (Fig. 20) located under pad (through the tube).
- Replace with new armrest pad.
- Reinstall screws (1) and tighten firmly.

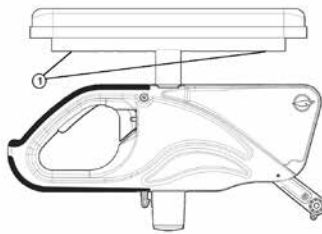

Fig. 20

10.6.5 Installing the Swing-away Armrest receiver

- Remove the two bolts (1) (Fig. 21).
- Align the armrest receiver with the mounting holes of the frame and of the transit securement anchor.
- Reinstall the bolts and tighten firmly.

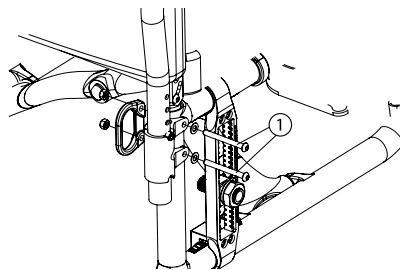

Fig. 21

10.6.6 Adjusting Swing-away Armrest height

- Pull the armrest out of the receiver (1) (Fig. 22).
- Remove screws (2) (Fig. 23).
- Inside the armrest tube, slide the dowel nut with a long flat screwdriver at the desired height (3)
- Reinstall screws (2).
- Reinsert armrest in receiver.

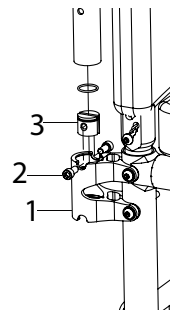

Fig. 22

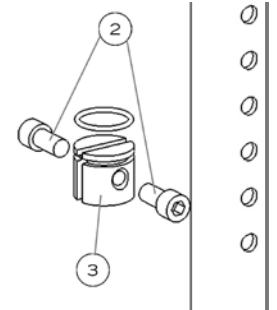

Fig. 23

10.7 Footrest length / Footplate angle

10.7.1 Adjusting Footrest length

- Loosen screw (1) (Fig. 24).
- Slide the extension tube inside the front rigging at the desired length within the limits.
- Tighten screw (1) firmly.

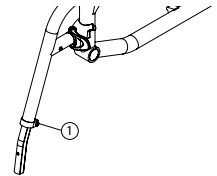

Fig. 24

10.7.1.1 Adjusting Footrest length (Swing away type)

- Remove screws on front riggings (1) (Fig. 24.1)
- Slide the extension tube inside the front rigging at the desired length.
- Reinstall screws (1) at desired length.
- Tighten screws firmly.

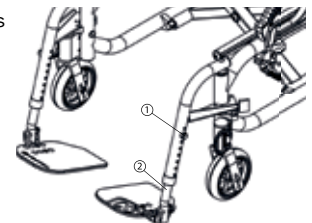

Fig. 24.1

10.7.1.2 Adjusting Footrest length (Single foot plate type)

- Loosen bottom 5mm Hex screws (1) on the right and left caster mount clamps (Fig 24.2)
- Slide the extension tube inside the front rigging at the desired length within the limits
- Tighten the screws (1) firmly.

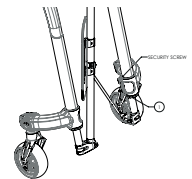

Fig. 24.2

i Do not remove or unscrew the security (PIN type) screws

10.7.2 Adjusting Footplate angle

- Loosen screws (1) (Fig. 24.3).
- Rotate the footplate at the desired angle.
- Tighten screws (1) firmly.

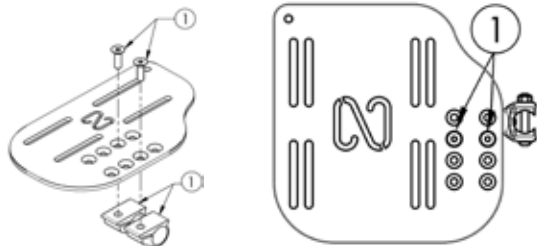

Fig. 24.3

10.7.3 Installing and adjusting the limb support



NEVER SIT ON AN LIMB SUPPORT



The limb support is not available on the VELOCE model

Installation: refer to the installation of the footrests in point 9.3.

- The limb support can be adjusted horizontally from left to right and up and down for height. It can also be placed closer to or further from the seat and the angle can be adjusted.
- To adjust the horizontal alignment from the left to right, slightly loosen the screws (1), slide the cushion horizontally to the desired position, then tighten the screws at a torque of 7 Nm.
- To adjust the limb support's angle, slightly loosen the screws (1), place the cushion at the desired angle and then tighten the screws at a torque of 7 Nm.
- To adjust the support in relation to the seat, slightly loosen the screws under the cushion (2), slide the support into the desired position and then firmly tighten the screws.
- To rotate the base horizontally, slightly loosen the screws (4) to be able to rotate the clamp on the main axle. Rotate the limb support to the right position and firmly tighten the screws in position at a torque of 7 Nm.
- To adjust for height, slightly loosen the screws (3) to allow the clamp to slide on the vertical axle. Slide the limb support into the desired position and then tighten the screws at a torque of 7 Nm.

NOTE: It's easier to adjust one axle at a time.

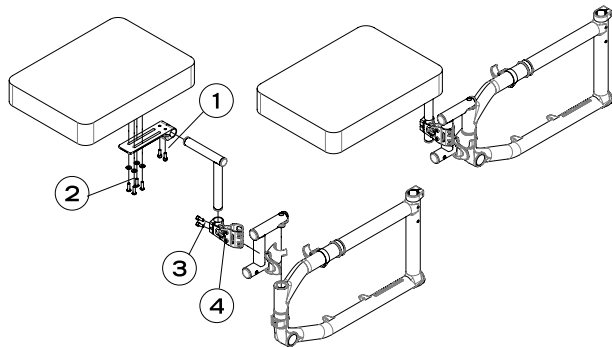

10.7..1 Cleaning the limb support

To clean the limb support, remove the cover and follow the same instructions as in point 10.4.2 for the seat cover and backrest.

10.8 Seat



It may be difficult to unfold the wheelchair if the seat upholstery has been installed too tight.

10.8.1 Replacing Seat Upholstery

SLIDE-ON SLING

- Partially close the wheelchair to remove tension in the seat upholstery
- Remove end cap (1) (Fig. 25).
- Slide in new seat upholstery.
- Reinstall end cap (1)
- Adjust tension with the velcro located under the seat upholstery.
- Fully open the wheelchair and make sure the upholstery is tight. The seat rails must be snapping easily in the seat rail supports.

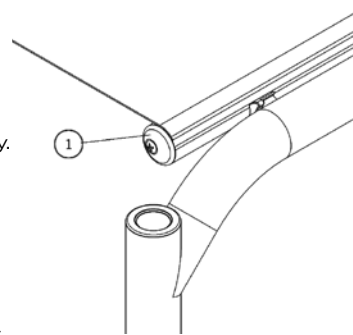

Fig. 25

10.9 Seat-to-floor height

Any modification to the seat-to-floor height involves adjustment of both anti-tippers, front caster angle, and rear wheel toe-in/ toe-out if equipped with 3° or 6° camber. It is important to do these adjustments before using the wheelchair as to reduce risk of injuries.

10.9.1 Changing the Front Seat-to-Floor Height

To change the front seat-to-floor height, you can do one of the following:

- Install the front caster in a different hole on the fork
- Install different caster size.
- Change the stem bold length (Standard, +1" (2.5 cm) and +2" (5.0 cm) available)

10.9.2 Changing Rear Seat-to-Floor Height

To change the rear seat-to-floor height, you do one of the following:

- Install the rear wheel axle bushing in a different position along the mounting plate.
- Install different sized rear wheels.

10.9.3 Changing Front & Rear Seat-to-Floor Height

To change the front and rear seat-to-floor height simultaneously, you can:

- Use another seat cushion with a different thickness.



10.10 Casters, forks and fork stem assemblies

10.10.1 Removing/Installing/Repositioning the caster

- Loosen nut (3) and remove bolt (1) (Fig. 26).
- Remove, install or reposition the front caster.
- Place spacers (2) between the caster and the fork.
- Tighten nut (3) firmly

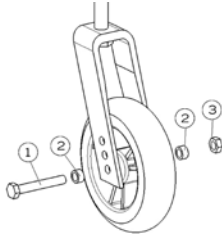

Fig. 26

10.10.1.1 Removing / Installing / Repositioning the caster (VELOCE)

Fig. 26.1

- Loosen and unscrew (1) (Fig.26.1).
- Slide out the fork wheel axle
- Remove, install or reposition the caster.
- Tighten screw (1) firmly.



10.10.2 Removing/Installing the caster housing

- Remove screw (1) (Fig. 27).
- Remove screw (2) (Fig. 28).
- Slide the caster housing out of the frame.

To reinstalled

- Slide the caster housing Plug in the frame (3).
- Reinstall caster housing (2).
- Reinstall screws (1).

*To change the stem bolt or to service the bearings, always remove the caster housing from the frame.

Fig. 27

Fig. 28

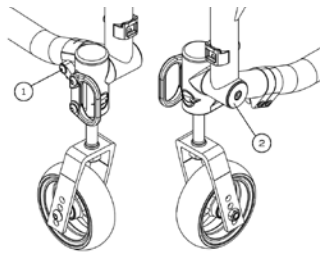

10.10.2.1 Veloce caster mount

- **DO NOT** remove security screws.
- The caster mount is only installed and adjusted at Motion Composites.



Fig. 28.1

10.10.3 Removing/Installing the stem bolt assembly (except Veloce)

Fig. 29

To remove the stem bolt:

- Remove screw (1) and washer (2) while holding the fork.
- Remove caster, fork and stem bolt assembly.
- Remove the dust protector (9).
- The caster wheel may need to be removed to take out stem bolt (7).
- Remove locknut (8) while holding the stem bolt (7) by the flat spot using a wrench.
- Remove the fork and perform maintenance if necessary.

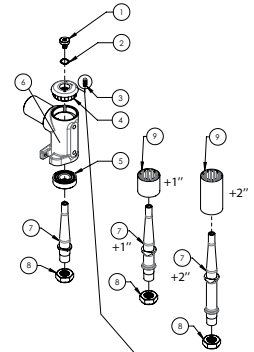

To install the stem bolt:

- Refer to the diagram to make sure all hardware is installed in the right order.
- Insert the stem bolt (7) into the fork (not showing) and tighten the locknut (8) while holding the stem bolt (7) by the flat spot using a wrench.
- Slide the dust protector (9) onto the stem bolt (7)
- Insert caster, fork and stem bolt assembly through the caster housing (6)
- Tighten the screw (1) and washer (2) while holding the fork (not showing) from the bottom to prevent the fork from turning.
- Adjust the friction of the stem bolt by turning the set screw (3).

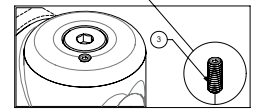

The set screw is used to add friction on the stem bolt to reduce caster flutter. Avoid overtighten the screw. Overtighten will cause damage to the anti-flutter system.

10.10.4 Adjusting the caster housing angle



Transit securement points are to remain in their original positions. Transit securement points are only designed to be used in their original position facing forward. Do not rotate transit securement points inward.

- All four wheels should be touching the floor.
- Use a set square and place it on the ground and along the caster housing.
- The housing should be parallel to the set square.
- If the housing is not parallel to the set square, remove the screws (4) (Fig. 30) and loosen the pivot bolt (3) (Fig. 30).
- Rotate the caster housing to adjust the angle while sliding clamp (5) on the frame.
- Tighten screw (3). This will hold the caster housing position.
- Check again that the caster housing is perpendicular to the ground using the set square. (Fig. 31)
- Reinstall the two screws (4) in the clamp (5).
- Tighten screws (4) to a snug fit.
- Final tightening should be done manually.

Fig. 30

Fig. 31

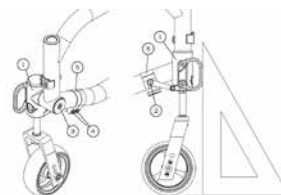

10.10.4.1 Move caster housing

- All four wheels should be touching the floor.
- Use a set square and place it on the ground and along the caster housing.
- The housing should be parallel to the set square.
- If the housing is not parallel to the set square, loose screws (2) (Fig. 31.1) sufficiently to remove the eccentric inserts (3) from the caster housing (1) (Fig. 31.2).
- Rotate the caster housing to adjust the angle.
- Replace the eccentric inserts (4) into the housing and tighten screws (2)
- Check again that the caster housing is perpendicular to the ground by using the set square.
- Final tightening should be done manually.

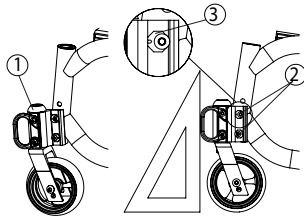

Fig. 31.1

Fig. 31.2

10.10.4.2 Veloce caster housing

Fig. 31.3

- All four wheels should be touching the floor.
- Use the integrated level on the fork housing.
- If the caster housing is not level, loosen the screws (1) (Fig 31.3)
- Rotate the caster housing to adjust the angle until the bubble is centered in the level.
- Tighten screws (1). This will hold the caster housing position.
- Check again the integrated level to make sure that the caster housing is perpendicular to the ground.



10.11 Rear wheels

10.11.1 Adjusting Quick-Release Axles

Fig. 32

- Remove the rear wheel from the wheelchair.
- Behind the quick release button, there is a nut that adjust the length of the axle.
- Hold the axle with a wrench at the other end (near the detent balls) (Fig. 32) and turn the nut behind the quick release button to change the length of the axle.
- Reinstall the quick release into the axle bushing on the wheelchair
- Quick release detent balls should extend beyond the axle bushing for a secure lock.

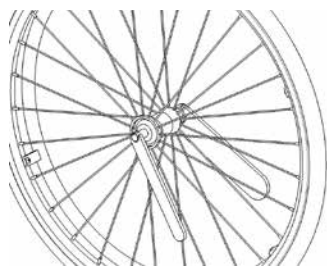

10.11.2 Replacing/Adjusting hand rims

- On the Newton one wheels the tire can stay in position.
- Use a plastic tire removal tool to take off the tire (1) (Fig. 33).
- Remove all nuts (2) inside the rim (3).
- Replace the handrim (4) with a new one and align the mounting holes (5).
- Reinstall and tighten the nuts firmly.
- Reinstall the tire on the rim.

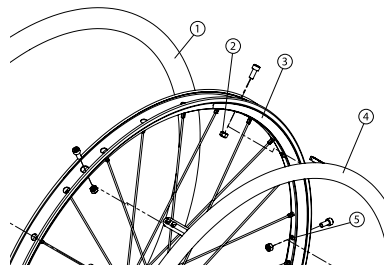

Fig. 33

10.11.3 Adjusting the rear axle height

- Loosen the nut holding the axle bushing. (3) (Fig. 34 - Fig. 35)
- Move axle bushing (1) along mounting plate (2).
- Reinstall the bushing in the desired mounting hole and tighten nut (3).

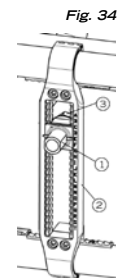

Fig. 34

10.11.3.1 Rear axle height (Move, Helio A6)

- Remove the nut (3) holding the axle bushing.
- Move axle bushing (1) (Fig. 34.1) along mounting plate (2).
- Reinstall the bushing in the desired mounting hole and tighten the nut (3).

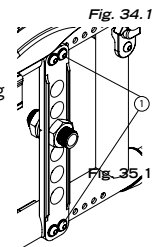

Fig. 34.1



The seat height, seat depth, back angle, seating system/upholstery, size/position of the rear wheels, size/position of the front casters, as well as the user condition directly relate to the stability of the wheelchair. Any change to one or any combination of the nine may cause the wheelchair to decrease in stability. These adjustments must be performed by a qualified technician. Seat-to-floor heights have specific positions depending on rear wheel size, rear wheel position, front caster size/position and seat-to-floor angle. These adjustments **MUST** be performed by a qualified technician

Fig. 35.2



10.11.4 Adjusting rear wheel spacing

The rear wheels can be adjusted laterally by repositioning axle bushing (1) (Fig. 35) on mounting plate (2).

- Loosen nuts (3) on the axle bushing (1).
- Turn the bushing (1) in the desired direction to adjust the spacing.
- Firmly tighten the nuts (3).
- Nuts can be switched from side to side for more adjustability.

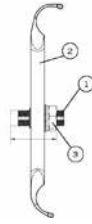

Fig. 35

10.11.4.1 Changing rear camber

Micro-adjustment V2 mounting plate

Note the position of the face plate (4) on mounting plate. Remove nut (1) and lock washer (2) holding the axle bushing (3).

Remove axle bushing (3) along face plate (4).

Change or replace the 3° axle bushing (3).

Change or replace the 0° or 3° mounting face plate (4) to reach a 3° or 6° angle.

Reinstall axle bushing, mounting face plate, lock washer and nut at the desired position on the V2 mounting plate.

Adjust the toe-in / toe-out of the rear wheels (see section 10.11.5).

Tighten the nut (1) of the mounting plate on the the right and left side of the wheelchair.

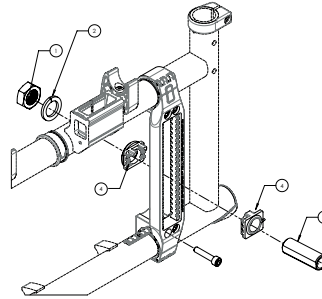

Standard T2 mounting plate

Note the position of the axle bushing (3) on the mounting plate.

Remove the 2 nuts (1) and lock washer holding the axle bushing (3).

Remove axle bushing (3).

Change or replace the 3° axle bushing (3).

Reinstall axle bushing, lock washer and nut at the desired position on the V2 mounting plate.

Adjust the toe-in toe-out of the rear wheels (see section 10.11.5).

Tighten the nut (1) of the mounting plate on the the right and left side of the wheelchair.

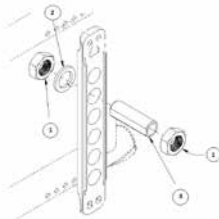

10.11.5 Adjusting the toe-in/toe-out with rear wheel camber.

Fig. 36

- Remove the rear wheel.
- Maintain the wheelchair on a horizontal plane with the support of the three other wheels.
- Loosen nuts (1) (Fig. 36) while keeping a bit of tension.
- Put the camber adjustment tool on the axle bushing.
- Use a set square and rotate the axle bushing so that the tool is parallel to the set square (and perpendicular to the ground).
- With one hand, hold the tool and the mounting plate together to keep the setting.
- With the other hand, use a ratchet to tighten firmly the nut (1) facing inside the wheelchair.

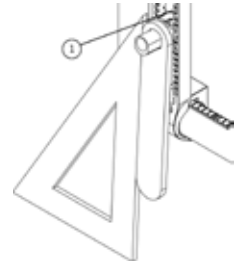

10.11.6 Adjusting the centre of Gravity

Remove the rear wheel.

Micro-adjustable Axle-Plate (A7, C2, XC2, Veloce)

Remove the 4 bolts (1) on the Axle-Plate. Move the axle plate to the desired position. Reinstall the 4 bolts (1) on the Axle-Plate and torque to 12 Nm.

Fig. 36.1

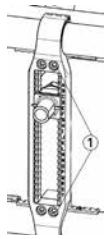
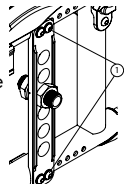

Fig. 36.2

Standard Axle-Plate (Move and A)

Remove the 4 bolts (1) on the Axle-Plate. Move the axle plate to the desired position. Reinstall the 4 bolts (1) on the Axle-Plate and torque to 7 Nm.



10.12 Wheel Locks

10.12.1 Replacing/Adjusting the wheel lock

- Loosen screws (1) (Fig. 37).
- Slide the wheel lock to the desired position.
- Tighten screws (1) to a snug fit. Final tightening should be done manually.
- Once engaged, the wheel lock should embed 3 mm into the tire.

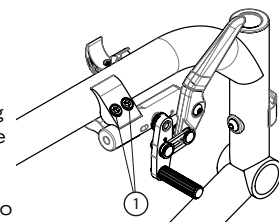

Fig. 37

10.13 Lock Extension

10.13.1 Replacing/Adjusting the wheel lock extensions

- Loosen screw (1) (Fig. 38).
- Align eyelet (2) with the mounting hole.
- Re-tighten screw (1) on the lock lever.

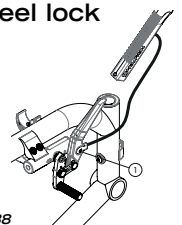

Fig. 38

10.14 Anti-tippers

10.14.1 Adjusting the Height of the Anti-tippers

Both anti-tippers **MUST** be used with your wheelchair at all times. Because anti-tippers are an option in some markets on this wheelchair, Motion Composites strongly recommends to order the anti-tippers as they are an important safeguard for the wheelchair user. Always use anti-tippers.

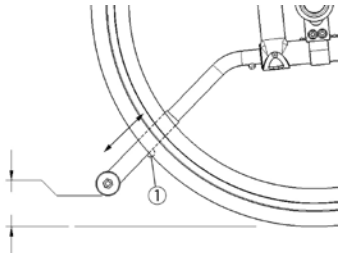

Fig. 39

The anti-tippers should be between 1½ and 2 inches (40 to 51 mm) off the ground. Improper spacing may result in wheelchair hang ups over obstacles or not preventing the wheelchair from tipping.

- Press the push-button (1) (Fig. 39) and slide anti-tippers extensions to desired length.
- Ensure the button snaps back into place.

i If you are unable to adjust the anti-tippers to the proper height, contact your Motion Composites dealer to replace your anti-tipper for another size.

10.14.2 Tipper-aids

Assistant can tip the wheelchair more easily to navigate over obstacles with a tipper-aid. Hold the wheelchair by the push handles.

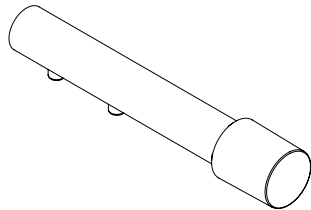

Press the tipper aid with your foot and hold the wheelchair in the tipped position until you have overcome the obstacle.

Installation:

Press the push-button on the anti-tippers to remove them. Insert the tipper-aid lever by pressing the push-button and sliding it in position.

! CAUTION! Risk of overturning!
Always reinstall anti-tippers when the tipper-aid are not in use.

Fig. 39.1

10.15. Headrest Kit and Headrest Support

10.15.1 Installing a headrest support

- Must be installed only on HD push-handle
- Cut the end of the push-handle with a knife in order to be able to see the inside of the push handle.
- Insert a 1/4"-20 grip nut (1) (Fig. 40) with the grip nut insertion tool (2) inside the handle (40 mm).
- Install fastening device of the headrest support by tightening it in the 1/4"-20 roll pin.

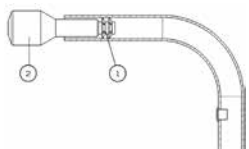

Fig. 40

10.15.2 Installing Headrest Kit

- Once the headrest support is installed, insert the adjustable headrest into the horizontal receiver.
- Install headrest on the ball pivot and tighten the three screws (1) (Fig. 41).
- Once the adjustment is completed, firmly tighten all parts.

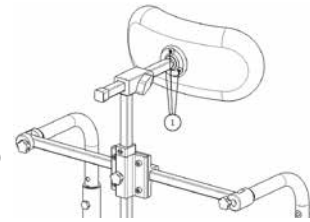

Fig. 41

10.16 Amputee Axle Plate

10.16.1 Installing an amputee axle plate

- Install mounting plate (1) (Fig. 42) by closing the clamps around the frame.
- Insert a second axle receiver (2) on the axle plate
- Install the back clamp (3) onto the rear of the frame.
- Insert two axle bushing (8) through axle plate (6) and in the two axle receiver (2) and secure with bolt and washer (4)(5).
- Insert two screws (7) into amputee axle plate through the mounting clamp and tighten.
- Insert axle bushing (8) through the amputee plate and tighten nuts (9).

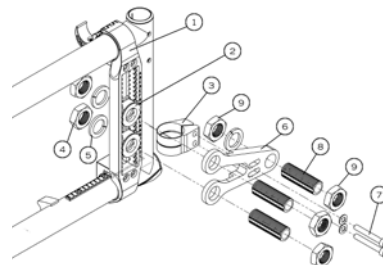

Fig. 42

10.16.1.1 Move/A6 amputee axle plate

- Install mounting plate (1) (Fig. 42.1) by bolting it to the frame.
- Install the back clamp (2) onto the rear of the frame.
- Insert 4 amputee plate adapters (3) on the mounting plate (1) at the desired position.
- Insert both bolts (4) and washers (5) into the back clamp (2) through amputee plate (6) and tighten.
- Insert axle bushing (7) through the amputee plate and insert nuts (8) and lock washer (9)
- Insert 2 bolts (10) through the mounting and amputee plate (1 and 6) and tighten with lock nuts (11).

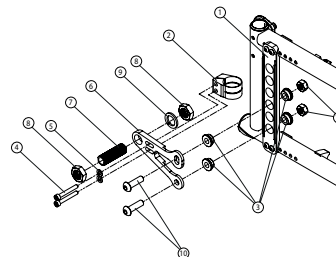

Fig. 42.1



10.17 Using a paratransit service



WARNING:

To reduce risk of injuries, Motion Composites recommend that wheelchair users should not be transported in any kind of vehicles while sitting in a wheelchair.

Motion Composites recognize that the safest transit option for a wheelchair user is to transfer into an appropriate seat in the vehicle and use the seat belts made available by the auto industry. Motion Composites cannot, and does not, recommend any wheelchair transporting systems.

The standard wheelchair seatbelt should never be used as a safety seat belt when sitting in a paratransit vehicle.

Transit regulation may vary in different legislation, states, provinces and countries. Only use a transit tie-down system that is approved in your legislation.

To avoid risk of injuries, remove all objects or accessories from the wheelchair and store them securely in the paratransit vehicle.



WARNING:

Identify whether your chair has been manufactured with the Transit Option installed.

If your chair is NOT equipped with the Transit Option:

1. **NEVER** let anyone sit in this chair while in a moving vehicle.
 - a. **ALWAYS** move the user to an approved vehicle seat.
 - b. **ALWAYS** secure the user with proper motor vehicle restraints.
2. In an accident or sudden stop the user may be thrown from the chair. Wheelchair seat belts will not prevent this, and further injury may result from the belts or straps.
3. **NEVER** transport this wheelchair in the front seat of a vehicle. It may shift and interfere with the driver.
4. **ALWAYS** secure this chair so that it cannot roll or shift.
5. Do not use any chair that has been involved in a motor vehicle accident.

If you fail to heed these warnings damage to your chair, a fall, tip-over or loss of control may occur and cause severe injury to the rider or others safety seat belt when sitting in a paratransit vehicle.



WARNING:

If the wheelchair is equipped with Motion Composites WC-19 Transit Tie-Downs, you must read the Transit Tie-Downs user guide at the end of this manual.

11. Motion Composites limited warranty

Refer to the Motion Composites warranty document.



IMPORTANT NOTICE REGARDING CONSUMERS RIGHTS

The benefits we give in this manufacturer's warranty are additional to, and do not detract from, any rights and remedies that you may have under local consumer protection laws.

This manufacturer's warranty is governed by the laws of the country, province, state or territory in which you purchased your Motion Composites product.

In many countries, consumers have statutory rights under local consumer laws. Those consumer rights may differ between countries, territories, states or provinces, and often cannot be excluded.

This Manufacturer's warranty is not intended to:

- change or exclude any statutory consumer rights that cannot be lawfully changed or excluded; or
- limit or exclude any right you have against the person who sold the Motion composites product to you if that person has breached their sales contract with you.

Our responsibility

Motion Composites' sole obligation and your exclusive remedy under this warranty shall be limited to such repair and/or replacement.

Warranty Service

If your wheelchair requires warranty service, please contact an authorized Motion Composites Dealer in Canada or an authorized international distributor. In the event of a defect in material or workmanship, the Dealer or Distributor must obtain a return authorization (RA) number from Motion Composites. Motion Composites issues RA numbers only to authorized Motion Composites Dealers and Distributors. In the event that you do not receive satisfactory warranty service, please write directly to **Motion Composites Customer Service** at:

160, Armand-Majeau Sud, Saint-Roch-de-l'Achigan, Qc, J0K 3H0

or send an email at: service@motioncomposites.com.

Do not return products to our factory without our prior consent.

CONSUMER NOTICE

- 1 The foregoing warranty is exclusive, and in lieu of all other express warranties, whether written or oral, express or implied. Motion Composites shall not be liable for any consequential or incidental damages whatsoever. By registering your Motion Composites wheelchair, you will be deemed to agree with all provisions of this warranty.
- 2 It is forbidden to alter or extend the foregoing express warranty or to waive any of the limitations or exclusions.

12. Particular damages

12.1 Damages requiring service by a qualified service agent

If any of the following conditions are observed, the wheelchair must be serviced by a qualified service agent:

- Any wheel adjustment;
- Any defective ball bearings of the forks;
- Any defective ball bearings of the front wheels;

12.2 Special damages that require the return of the wheelchair to the manufacturer

If any of the following conditions are observed, always contact your service agent prior to sending your wheelchair for repairs at Motion Composites.

- Part of the frame or cross brace is cracked;
- The thread of a rivet-nut is damaged;
- Part of the frame or the cross brace is broken;
- Cross brace becomes worn;
- Problems continue to be identified after several adjustments or repairs have been made by a qualified service agent.

12.3 Repair procedure

Parts that could be repaired by the owner:

Rear tire and inner tube.

- Parts serviced by the manufacturer or service center:
All parts of the wheelchair except for the tires and the inner-tubes
- Parts that can be removed and sent to the manufacturer/ distributor or other party for repair:
Wheels, arm rest, foot rest, upholstery, cushion
- Circumstances in which the wheelchair should be sent for service:
Broken bearings, loose spokes, wheel not aligned, loose bolt, abnormal vibrations, noise or any deviation in the frame, front stem is not perpendicular to floor, broken part like anti-tippers, back canes, rips or tear on the upholstery and for the yearly inspection
- Please contact our customer service agent for the complete list of distributors or service centers.
<http://www.motioncomposites.com/en/team/>
- Some dealers may offer replacement units during the service period. Please contact you service agent for full details. Motion Composites will hold replacement parts for a minimum of 10 years or propose a compatible spare option.
- If the wheelchair needs to be sent to a service center or to the manufacturer for service, it should be packed carefully in a cardboard box fitting the size of the wheelchair. The anti-tippers, the foot rest and cushion should be removed and packed in a small box inside the larger cardboard box containing the wheelchair. The wheelchair should be protected with a protective film to prevent from scratches or wear.

Tools

Allen key	Keys:
2 mm	10 mm
2.5 mm	11 mm
3 mm	1/2" (13 mm)
4 mm	
5 mm	

For Quick Release:	Other:
7/16" (11 mm)	Wrench
3/4" (19 mm)	Phillips screwdriver
26 mm	

13. Maintenance and Safety Inspection Checklist

At every use

Make sure wheelchair rolls easily and straight.

Check for vibrations, noise or any deviation from normal functioning.

Ensure wheel locks are working properly.

Ensure wheel quick release are engaged and locked properly.

Ensure that front stem is perpendicular to floor.

Visually inspect tires (front & rear) for debris, low pressure, flat spots or wear.

Make sure anti-tipper tubes are locked in place (if equipped).

Visually inspect fabric for protruding metal, rips or tears.

Ensure that hand grips are not loose (if equipped).

Check hand rims for rough edges and make sure they are free from grease or other contaminants.

Checks for component interference.

Check for irregular noise and rattles.

Weekly

Check tire pressure with a tire gauge

Check seat upholstery tension - It should be straight when the wheelchair is open and set in position.

Monthly

Check wheel alignment.

Check for free running of fork bearings.

Inspect bolts and screws and tighten if necessary

Yearly

Have a complete inspection performed by a qualified technician.



Tire pressure could be adjusted by the owner or an assistant with the proper tools. If any part appears not to work properly after inspection, the wheelchair should be immediately sent for repair to a qualified technician.



Disposal and Recycling the wheelchair
In the case of disposal, return the device to your dealer or rehabilitation center. All components of the product should be disposed and recycled in accordance with national environmental laws and standards.



WC-19 Transit Tie-Downs



WARNING

Read all these pages before using the Motion Composites wheelchair Transit Tie-Downs

- Use proper equipment/use only as instructed
- Use only Original Equipment Manufacturer (OEM) seating and restraint systems
- Use appropriate tie down systems and use them properly
- Avoid using improper equipment/secure other equipment

The following information relates to the Motion Composites wheelchairs equipped with a factory installed WC-19 transit tie downs. Read this information completely before use in a motor vehicle. If you have any questions about this information or about using your wheelchair as a seat in a motor vehicle, contact your authorized Motion Composites rehab specialist.

AVOID USING IMPROPER EQUIPMENT/SECURE OTHER EQUIPMENT IN A MOTOR VEHICLE.

1. INTRODUCTION

The Motion composites wheelchairs are available with a WC-19 Transit Tie-Down. This option is only offered as a factory-installed option.

The Transit Tie-Down option has been crash-tested in accordance and complies with RESNA WC-4:2012, Section 19 ("WC19") for frontal impact Test, with a 169.4-lb. (77 kg) surrogate occupant corresponding to a user weight range of 115-210 lb (52.16-95.25 kg). The Motion Composites Transit Tie-Down Package conforms to these standards for the purpose of enabling wheelchairs to be secured in certain types of motor vehicles. The WC-19 Transit Tie-Down option consists of four factory-installed Tie-Down Brackets, a factory-installed Pelvic Belt with 2 Mounting Brackets on a standard frame. It is approved for OCCUPIED transit use.

Therefore, there are several important considerations that users of Motion Composites Transit Option must keep in mind. First, only tests for wheelchair performance where the wheelchair, secured in the forward-facing position, is involved in a frontal impact collision at 30 mph (48 kph). It does not test for wheelchair performance in any other type of collision, including, without limitation, side impacts, rear impacts, rollovers or higher speed frontal impacts. Second, compliance with WC-19 does not guarantee that the occupant will not be injured, even in a frontal impact collision at 30 mph (48 kph) or less. In such an impact, the forces experienced are very severe and injuries can be sustained even if the wheelchair performs exactly as required by the standard.

Accordingly, ANSI/ RESNA WC/19 include numerous warnings to the effect that "wheelchair users should transfer to the vehicle seat and use the vehicle-installed restraint system whenever it is feasible."

A Motion Composites wheelchair transport option, for an UNOCCUPIED wheelchair, is also available as an aftermarket, field installation option for the Helio C2, HELIO A7, Helio XC2, Helio Kids, Helio A6, and Move. This Wheelchair UNOCCUPIED Transport Option has NOT been crash-tested in accordance with WC19.

The Wheelchair Transport Option only includes four Tie-Down Brackets. It is only approved for transportation of an UNOCCUPIED wheelchair.

To determine whether your Motion Composites wheelchair is equipped with the WC-19 Transit Tie-Down Option or the Wheelchair Transport Option, see Fig. 1 (page 7).

You should contact Motion Composites Customer Service, with any questions you may have about using this wheelchair for seating in a motor vehicle, at 1-866-650-6555.

DO NOT modify your wheelchair in any way by a non-authorized Motion Composites center.
DO NOT make alterations or substitutions to the wheelchair structural parts or frame components without consulting Motion Composites.

2. LABELING

Read label



READ

Read and follow the information in the owner's manual and all supplemental information provided with the wheelchair before initial operation.

WC-19 Label



WC-19

Indicates that tested and approved wheelchair, with similarly labeled tested and approved seating system, conforms to ANSI/RESNA WC/Vol. 4, Section 19 for transport of an occupied wheelchair in a motor vehicle.

Securement Label



SECUREMENT

Indicates wheelchair securement points which conform to ANSI/RESNA WC/Vol. 4, Section 19.

Warning Label



WARNING

Indicates a potentially hazardous condition/situation. Failure to follow designated procedures can cause either personal injury, component damage, or malfunction. On the product, this icon is represented as a black symbol on a yellow triangle with a black border.

Mandatory Label



MANDATORY

These actions should be performed as specified. Failure to perform mandatory actions can cause personal injury and/or equipment damage. On the product, this icon is represented as a white symbol on a blue dot with a white border.

Prohibited Label



PROHIBITED

These actions are prohibited. These actions should not be performed at any time or in any circumstances. Performing a prohibited action can cause personal injury and/or equipment damage. On the product, this icon is represented as a black symbol with a red circle and red slash.

Important Label



IMPORTANT

Indicates important information to remember when using this product.

3. DEFINITION

ANSI/RESNA: American National Standards Institute/ Rehabilitation Engineering and Assistive Technology Society of North America

ISO: International Standards Organization

Transit Tie-Downs Package: Equipment installed on the wheelchair which allows the wheelchair to be anchored in a motor vehicle. The Motion Composites transit tie-down equipment consists of tie-down anchor points and a pelvic belt.

Wheelchair Tie-down and Occupant Restraint System (WTORS): Equipment installed in a motor vehicle which allows a wheelchair and/or a wheelchair-seated occupant to be anchored in the motor vehicle for limiting occupant movement in a motor vehicle crash. The equipment consists of a system or device for securing the wheelchair and a belt-type restraint system.

Securement Points: Specific structural points on the wheelchair base or seat frame that are designed for attachment of a WTORS. These securement points are indicated by anchor symbols.

4. PROTOCOLS AND PROCEDURES

The wheelchair user should transfer into the vehicle seat and use the vehicle installed restraint system if and whenever feasible. The wheelchair should then be stored and secured in the vehicle.

If it is found necessary at the user's discretion to secure a wheelchair to a vehicle, the vehicle must be equipped with a Wheelchair Tie-down and Occupant Restraint System (WTORS) that has been installed in accordance with the tie-down manufacturer's instructions, and is compliant with ANSI/RESNA WC/Vol. 4, Section 19 standards, and the wheelchair must have a transit securement package conforming to the ANSI/RESNA WC/Vol. 4, Section 19 standards. It is essential to use a complete WTORS to secure the wheelchair to the vehicle and to provide the wheelchair occupant with a properly designed and tested safety restraint system.

A restraint system with both pelvic and upper torso belts must be used to protect the wheelchair occupant and minimize the likelihood of injury caused by contact with the vehicle during a crash or sudden braking.



5. USER SAFETY INFORMATION

This Chapter contains detailed information regarding the exact configuration of the Motion Composites wheelchairs that were subjected to the frontal impact and other tests required by WC-19. The results of that testing apply only to the configuration of the wheelchair as tested and described herein. Therefore, if you order your wheelchair differently, such as with a seating system manufactured by someone other than Motion Composites, you are hereby advised that the wheelchair was not tested in such different configuration and should not be considered “transit approved” by Motion Composites. Because Motion Composites has not tested the chair with such different configurations, Motion Composites has no knowledge of how the product would perform in such configuration. Therefore, Motion Composites makes no claims or warranties about the wheelchair’s performance in any configuration other than the configuration described herein. Motion Composites has not authorized any person to make any such claims or warranties on its behalf.

6. WARNINGS



WARNING

You should contact Motion Composites Customer Service, with any questions you may have about using this wheelchair for seating in a motor vehicle, at 1-866-650-6555 .



WARNING

This Chapter contains detailed information regarding the exact configuration of the wheelchair that was subjected to the frontal impact and other tests required by WC-19. See “Motion Composites Wheelchair Test Configuration” Section 11. The test results apply only to the configuration of the wheelchair as tested and described herein. Therefore, if you order your chair differently, such as with a seating system manufactured by someone other than Motion Composites, you are hereby advised that the wheelchair was not tested in such different configuration and should not be considered “transit approved” by Motion Composites. Because Motion Composites has not tested the chair with such different configurations, Motion Composites has no knowledge of how the product would perform in such configuration. Therefore, Motion Composites makes no claims or warranties about the wheelchair’s performance in any configuration other than the configuration described herein. Motion Composites has not authorized any person to make any such claims or warranties on Motion Composites’ behalf.



WARNING

The wheelchair equipped with Motion Composites Transit Tie Down Option has been dynamically tested in a forward-facing orientation for a 30 mph (48-km/h) frontal impact with varying weights, as set forth in the “Motion Composites Wheelchair Test Configuration” Section 11. The wheelchair equipped with Motion Composites Transit Tie Down Option has met the performance requirements for traveling forward-facing in frontal impact conditions, and it should be used ONLY for forward-facing seating in motor vehicles. Its use in other orientations (e.g., rearward-facing or sideways-facing) has not been tested, and it should NOT be used in such other orientations.



WARNING

Do not ride this wheelchair in a motor vehicle if your weight, together with the weight of all items attached to the wheelchair (such as backpacks, seat pouches, etc.) is more than 265 lb (120 kg).



WARNING

Alterations or substitutions should NOT be made to the wheelchair securement points or to structural or frame parts or components. The Motion Composites wheelchairs were tested in the configurations with the components specified in the “Motion Composites Wheelchair Test Configuration” Section 11. Any significant modification or substitution to the wheelchair’s components or seating could significantly alter the chair’s performance during an impact.



WARNING

Motion Composites expressly disclaims that use of its Transit Option on a Motion Composites wheelchair will prevent the wheelchair user from injury or death in the event of a motor vehicle accident.



WARNING

A sudden stop and/or collision may structurally damage your wheelchair. Such damage may not be visible. IMMEDIATELY STOP using any wheelchair that is or was involved in any such incident. Because the structural damage may not be visible, you MUST replace any wheelchair that is or was involved in any such incident.



WARNING

Whenever feasible, wheelchair users should transfer into the vehicle seat and use the Original Equipment Manufacturer (OEM) vehicle-installed restraint system and the unoccupied wheelchair should be stored in a cargo area or secured in the vehicle during travel.

USE APPROPRIATE TIE DOWN SYSTEMS AND USE THEM PROPERLY

**WARNING**

Our Motion Composites wheelchair **MUST** be used with Wheelchair Tie Down and Occupant Restraint Systems (WTORS) that meet the requirements of the SAE (Society of Automotive Engineers) J2249 Recommended Practice – Wheelchair Tie Down and Occupant Restraint Systems for Use in Motor Vehicles (SAE J2249). Do **NOT** use other WTORS that are designed to rely on the wheelchair structure to transfer occupant restraint loads to the vehicle.

**WARNING**

Do not use your Motion Composites wheelchair with a WTORS unless the WTORS has been installed fully in accordance with the instructions of the manufacturer of the WTORS and SAE J2249.

**WARNING**

Always attach the WTORS to your Motion Composites wheelchair at all four (4) of the Motion Composites Transit Option securement points in accordance with the instructions provided by the manufacturers of the WTORS and SAE J2249.

Note: See Figure 4 for the location of the four (4) Motion Composites installed WTORS securement points.

**WARNING**

ALWAYS attach vehicle-anchored occupant restraints (pelvic belts and upper torso belts) in accordance with the instructions of the manufacturer of such restraints and SAE J2249.

USE PROPER EQUIPMENT/USE ONLY AS INSTRUCTED**WARNING**

You **MUST** use your wheelchair in strict accordance with all warnings and instructions contained in this Owner's Manual.

**WARNING**

The wheelchair equipped with Motion Composites's Transit Option was dynamically tested in a forward-facing orientation with the specified anthropomorphic test dummy restrained by **BOTH** a vehicle-anchored pelvic belt and a vehicle-anchored upper torso belt. **BOTH** pelvic and upper torso (shoulder) belts should be used to reduce the possibility of head and chest impacts with components of the motor vehicle.

MOTION COMPOSITES REQUIRES THAT BOTH PELVIC AND UPPER TORSO BELTS BE USED FOR MAXIMUM PROTECTION IN A FRONTAL IMPACT COLLISION.**WARNING**

The backrest angle may be adjustable on your Motion Composites wheelchair. You must adjust the backrest angle so that it does not exceed the angle specified in appendix "Disclosure information" on page 24 of the Owners Manual, when the wheelchair is occupied during transit in a motor vehicle.

**WARNING**

Postural supports, such as pelvic positioning belts, anterior trunk supports and lateral trunk supports should **NOT** be relied on for occupant restraint in a moving vehicle unless they are labeled as being in accordance with WC-19.

**WARNING**

Posturing and positioning accessories, such as pelvic positioning belts, anterior trunk supports and lateral trunk supports, should **NEVER** be relied upon for occupant restraint in a moving vehicle unless they are labeled as being in accordance with the requirements specified in WC-19.

**WARNING**

Whenever possible, other auxiliary wheelchair equipment should be either effectively secured to the wheelchair or removed from the wheelchair and secured in the vehicle during travel so that such equipment does not break free and cause injury to the vehicle occupants in the event of a collision.

**WARNING**

On order to reduce the potential of injury to vehicle occupants, wheelchair-mounted trays and other accessories, such as IV poles, respiratory equipment, backpacks and other personal items, not specifically designed for crash safety should: (i) be removed and secured separately in the vehicle, or (ii) be secured to the wheelchair but positioned away from the occupant with energy absorbing padding placed between the tray or other accessory and the occupant.

**WARNING**

IF YOU FAIL TO OBSERVE THE WARNINGS IN THIS SUPPLEMENT, YOU MAY DAMAGE YOUR WHEELCHAIR, CAUSE SEVERE PHYSICAL INJURY TO OTHERS OR SUFFER SEVERE PHYSICAL INJURIES YOURSELF, UP TO AND INCLUDING DEATH.



7. SECURING THE WHEELCHAIR

NOTE: In addition to following the general guidelines below, be sure to follow all recommendations and instructions provided by the WTORS manufacturer.

Always secure the wheelchair and occupant in a forward-facing position in the vehicle.



WARNING
Attach the four tie-down straps only to designated, labeled transit securement points indicated by anchor symbols on the wheelchair.
See figure 1.

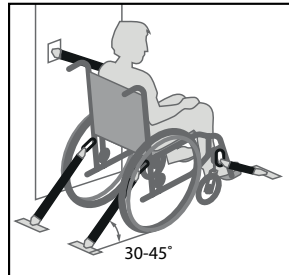

Figure 1. Securing the Wheelchair

Tighten the straps to sufficiently remove all slack. Never attach tie-downs to adjustable, moving, or removable parts of the wheelchair such as armrests, front riggings, and wheels.

Position the anchor points for the rear tie-down straps directly behind the rear securement points on the wheelchair. The front tie-down straps should anchor to floor points that are spaced wider than the wheelchair to provide increased lateral stability. See figure 2.

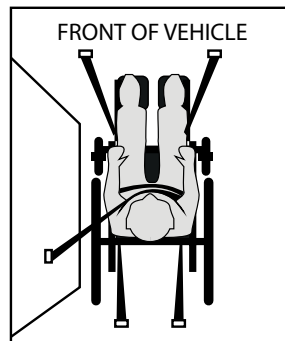

Figure 2. Securing the Wheelchair



WARNING
Always allow for proper clear zones when securing an occupied wheelchair in a motor vehicle. The frontal clear zone (FCZ) is measured from the forward most point on the occupant's head and should measure at least 26 in. (66 cm) if both a pelvic and upper-torso belt are used. See figure 3.

NOTE: The recommended frontal clear zone may not be achievable for wheelchair-seated vehicle operators.

The rear clear zone (RCZ) is measured from the rearmost point on the occupant's head and should measure at least 16 in. (40.64 cm). See figure 3.

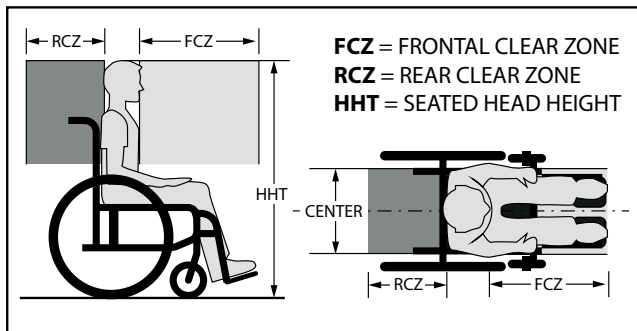

Figure 3. Recommended Pelvic Belt Placement Angles

The seated head height (HHT) ranges from about 47 in. (120 cm) for a small adult female to about 61 in. (155 cm) for a tall adult male. See figure 3.



WARNING
Allow as much clearance as possible around the wheelchair occupant to reduce the possibility of contact with vehicle components and other passengers in the event of a crash.



WARNING
Ensure all vehicle components that are in close proximity to the wheelchair occupant are removed or covered with dense padding.

Motion Composites Transit Tie-Down Package

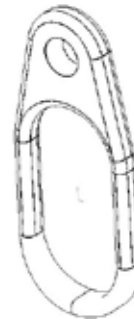

Rear Tie Down

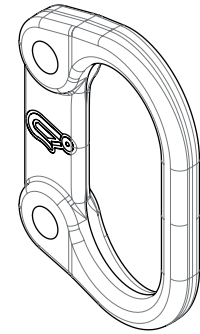

Front Tie Down

The Motion Composites Transit Tie-Down Package includes belt restraint anchor points in conformance with ANSI/RESNA WC/Vol. 4, Section 19.

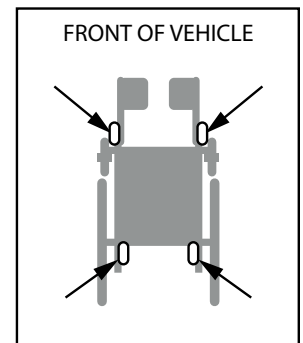

Figure 4. Tie Down Location

8. SECURING THE WHEELCHAIR OCCUPANT

Once the wheelchair has been properly secured, it is essential that the wheelchair occupant be protected for transport.



WARNING

The pelvic belt should be angled between 45 and 75 degrees to the horizontal when viewed from the side. However, if the user cannot achieve this standard, an optional zone of 30 to 45 degrees can be utilized safely. Some wheelchair components, like armrests and wheels, can interfere with proper belt fit. It may be necessary to insert the belt between the armrest and the seatback or through openings between the backrest and seat in order to avoid placing the pelvic belt over the armrest. See figure 5.

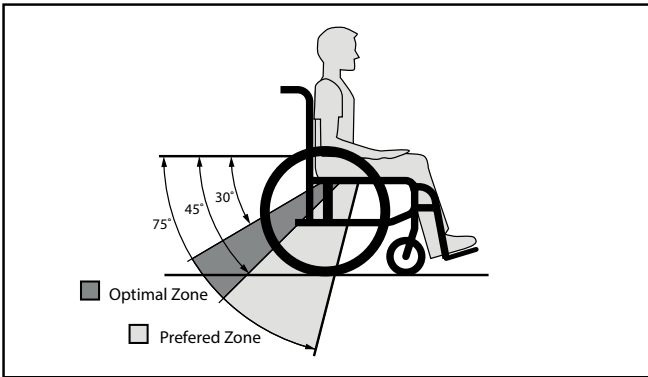

Figure 5. Recommended Pelvic Belt Placement Angles



WARNING

The wheelchair occupant must be secured with dynamically crash-tested and approved pelvic and upper-torso belts or with a five point child restraint harness as part of WTORS. Place the pelvic belt across the front of the pelvis near the upper thighs, not high over the abdomen. Place the upper-torso belt across the middle of the shoulder and the center of the chest, and connect to the pelvic belt near the hip of the wheelchair occupant. See figure 6.

See figure 6.

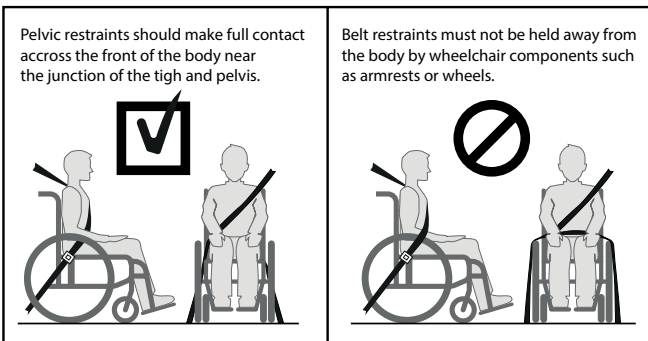

Figure 6. Proper Pelvic Belt Placement



WARNING

The upper torso belt webbing should not be worn twisted in a manner that reduces the area of contact of the belt with the occupant. The upper-torso belt anchor point should be anchored above and behind the top of the wheelchair occupant's shoulder to ensure that the occupant is properly restrained during transport. Both the pelvic and upper-torso belt restraints should be adjusted as snugly as possible consistent with user comfort. See figure 7.

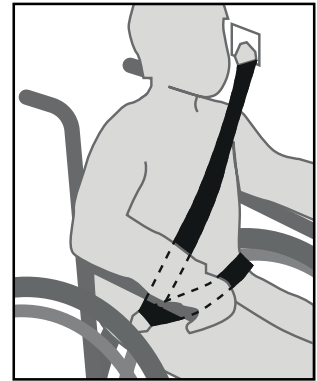

Figure 7. Upper-Torso Belt Placement



WARNING

The buckle of belt restraint systems should not be located near wheelchair components that may come in contact with the buckle release button in the event of a vehicle accident or collision.

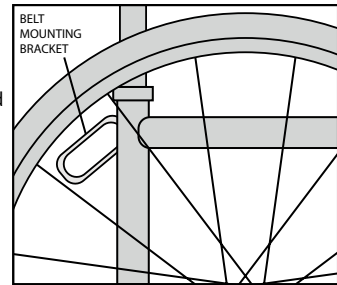

Figure 8. Wheelchair Belt Restraint Anchor

If your wheelchair is equipped with a crash-tested

pelvic belt that is anchored to the wheelchair frame, complete the restraint system by attaching the lower end of the WTORS upper-torso belt to the pelvic belt by referring to the WTORS manufacturer's instruction. Crash-tested wheelchair-anchored pelvic belts will be labeled to indicate compliance to the ANSI/RESNA WC/Vol 4, Section 19 standards. See figure 8, 9.

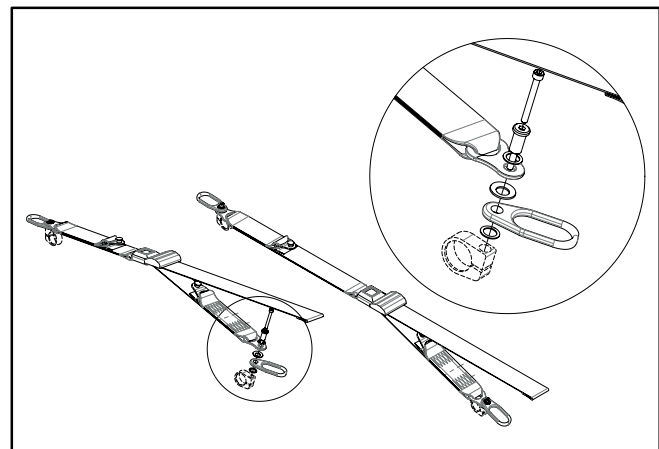

Figure 9. Wheelchair-anchored Belt Restraint



MANDATORY

A vehicle-anchored belt restraint system conforming to ANSI/RESNA WC/Vol 4, Section 19 must be used if the wheelchair occupant chooses not to utilize a manufacturer-installed wheelchair-anchored belt restraint system.



WARNING

Although postural supports and belts may be used in a moving vehicle in addition to the occupant belt restraint system, they should not be relied upon to replace occupant restraints that have been designed and tested for this purpose and should not interfere with proper belt restraint placement.

9. TRANSIT SECUREMENT PACKAGE

The following components of the transit securement package must be compliant to ANSI/RESNA WC/Vol. 1, Section 18 (formerly SAE J2249) and must be installed according to the manufacturer's instructions.

- Wheelchair Tie-down and Occupant Restraint System (WTORS)
- 3-point occupant restraint seatbelts
- Tie-down end fittings
- WTORS securement points
- Occupant restraint securement points

NOTE: To obtain a copy of ANSI/RESNA WC/Vol. 1, Sections 18 and/or 19 visit <http://www.ansi.org>.

10. IMPORTANT POINTS TO REMEMBER



MANDATORY

Read and follow all manufacturers' instructions, including the product owner's manual.



MANDATORY

Any WTORS or wheelchair involved in a vehicle crash should be replaced.



WARNING

The wheelchair seatback should be positioned at an angle of no more than 20 degrees to the vertical. If a greater recline angle is required, the upper-torso belt anchor point should be moved rearward along the vehicle's sidewall to ensure that the belt maintains contact with the wheelchair occupant's shoulder and chest.



WARNING

Visually inspect all WTORS equipment according to WTORS manufacturers' instructions on a regular basis, and have worn or broken components replaced immediately. Ensure anchorage track is free of dirt and debris.



WARNING

Remove hard trays and stow or secure them elsewhere in the vehicle to reduce the chance of wheelchair occupant injury from contact with the tray.



WARNING

Consider using foam trays in place of rigid trays during vehicle transport. If that is not possible, place dense foam padding between the wheelchair occupant and the tray, and make sure that the tray is securely attached to the wheelchair so that it will not break loose and cause injury to other occupants in a crash.



WARNING

Ensure the wheelchair occupant is properly positioned to protect the neck during rear impact.



WARNING

Secure all removable accessories including clothing guards, medical, and other equipment to the wheelchair or vehicle to prevent injury during a crash.



WARNING

If head and neck support is required during travel, use a soft, light neck collar as they are less likely to cause neck injury in a crash. Do not attach the soft collar to the wheelchair or seating system.

11. TEST CONFIGURATION

Seat Width	18 in.
Seat Depth	18 in.
Seat Back Height.	20 in.
Front Seat Height	18 in.
Rear Seat Height	15.75 in.
Seat Angle	7 degrees
Seat Back Angle	90 degrees with a 8 degree bend at 8 in.
Wheelchair Weight	37 lb.
Seat Sling Tension	Adjustable Slide-On
Back Upholstery	Slip-on
Backrest Type	Aluminum Adjustable Height 18-21 in.
Footrest Angle	70 degrees
Rear Wheels	24" spoke wheels with 0 degrees of camber
Rear Tire	Soft Urethane 1.25 in
Casters	6" Polyurethane tire on a 3-spoke composite wheel
Footrest	Aluminum adjustable angle
Other Options	None
Mass of ATD	172 lb.
Maximum User Weight.	265 lb

WHEELCHAIR TOTAL WIDTH

Wheelchair total width	CAMBER ANGLE								
	0°			3°			6°		
Handrim position	Ultra-Narrow	Narrow	Standard	Ultra-Narrow	Narrow	Standard	Ultra-Narrow	Narrow	Standard
To add to the width of the wheelchair (Inch) Wheels 20" to 26"	6 3/4	7 1/2	8 1/4	8 3/8 to 8 3/4	9 1/8 to 9 1/2	9 7/8 to 10 1/4	9 3/8 to 10	10 1/8 to 10 3/4	10 7/8 to 11 1/2
To add to the width of the wheelchair (cm) Wheels 20" to 26"	17.1	19.1	21.0	21.3 to 22.2	23.2 to 24.1	25.1 to 26.0	23.8 to 25.4	25.7 to 27.3	27.6 to 29.2

Example: an 18" wide wheelchair with a 0° camber and a standard handrim position will have a total width of 26-1/4"



DECLARATION OF CONFORMITY

Name and Address of Product Owner

Motion Composites
160, Armand-Majeau Sud, St-Roch-de-l'Achigan
Quebec, Canada, J0K 3H0
Phone: 1-866-650-6555
Fax: 1-888-966-6555
support@motioncomposites.com
www.motioncomposites.com

Authorized representative

Advena Ltd.
Tower Business Centre, 2nd Flr.
Tower Street, Swatar, BKR 4013, Malta

We hereby declare that the below mentioned devices have been classified according to the classification rules and conform to the Essential Principles of Safety and Performance as laid out in the Health Products (Medical Devices) Regulations 93/42/CEE.

Medical Device(s):

Motion Composites, Helio C2, A7, A6, XC2, Veloce, Move, Kids, manual wheelchair

Manufacturing site:

Motion Composites
160, Armand-Majeau Sud, St-Roch-de-l'Achigan
Quebec, Canada, J0K 3H0

Risk classification:

Class 1 Medical Device (per 93/42/CEE).

Standards applied:

- **NF EN ISO 7176-1:**
Wheelchairs, part 1: Determination of static ability.
 - **NF EN ISO 7176-5:**
Wheelchairs, part 5: Determination of dimensions, mass and maneuvering space.
 - **NF EN ISO 7176-8:**
Wheelchairs, part 8: Requirements and test methods for static, impact and fatigue strengths.
 - **NF EN ISO 7176-11:**
Wheelchairs, part 11: Test Dummies.
 - **NF EN ISO 7176-15:**
Wheelchairs, part 15: Requirements for information disclosure, documentation and labeling.
-

This declaration of conformity is valid from 2013/01/16.

Conversion chart

Inches	Metric	Inches	Metric	Inches	Metric	Inches	Metric
1/4"	0.6 cm	1"	2.5 cm	10"	25.4 cm	19"	48.3 cm
1/2"	1.3 cm	2"	5.1 cm	11"	27.9 cm	20"	50.8 cm
3/4"	2.0 cm	3"	7.6 cm	12"	30.5 cm	21"	53.3 cm
		4"	10.2 cm	13"	33.0 cm	22"	55.9 cm
		5"	12.7 cm	14"	35.6 cm	23"	58.4 cm
		6"	15.2 cm	15"	38.1 cm	24"	61.0 cm
		7"	17.8 cm	16"	40.6 cm	25"	63.5 cm
		8"	20.3 cm	17"	43.2 cm	26"	66.0 cm
		9"	22.9 cm	18"	45.7 cm		

Motion Composites

160, Armand-Majeau Sud
 Saint-Roch-de-l'Achigan, Quebec
 J0K 3H0 Canada
 Phone: 1-866-650-6555
 Fax : 1-888-966-6555
support@motioncomposites.com
www.motioncomposites.com