



panthera®

Operating instructions for wheelchair:
Micro 3

CE

Micro 3

CONTENTS	PAGE
Introduction/ Intended use	2
Design/Contact/Symbols	3
Description/Overview	4
Safety regulations	5 - 8
Transfer/Lifting	7
Settings	8 -15
Accessories	15
Maintenance/Service/Repair	16 - 18
Guarantee/Conformity	19
Technical facts	20-21



INTRODUCTION

Congratulations on choosing a wheelchair from Panthera AB. We hope you will be satisfied with your Panthera Micro 3 and wish you many happy years together. All of Panthera AB's products are designed and assembled in Spånga, outside Stockholm. Our models are constructed to be the very best on the market with regard to quality, manoeuvrability and low weight.

Please ensure you carefully read the instructions.

To view the images and text more clearly, you can also read the instructions digitally at

www.panthera.se

INTENDED USE

Panthera Micro 3 wheelchairs are built for children, between 1-5 years, who need a manual dynamic wheelchair for everyday use, indoor use and outdoor use on flat surfaces under adult supervision. These wheelchairs are made to be used by children with physical disabilities and are not limited to specific diagnosis. Each person's individual function capacity and limitations indicates whether a manual dynamic wheelchair is suitable as a mobility aid. Wheelchair model recommendations should be given by trained healthcare professionals, and the appropriate product should then be tested and adjusted by an expert for the optimal sitting and driving characteristics. The wheelchair's design and settings are tested for each individual.

Intended use is together with a seat cushion to distribute pressure evenly over the seat. Changing the cushion can change the user's stability. If the height of the cushion changes, the settings of the wheelchair need to be reviewed by qualified personnel to ensure that the settings are correct.

Seat cushions with CE-marking are approved for use in the product.

DESIGN

Panthera's Micro 3 wheelchairs are designed with a focus on good ergonomics when sitting or driving. The wheelchair is designed to have as low a weight as possible. The wheelchair's exterior is small and it is very light. It is available in two versions, Micro 3 and Micro 3 Long. If required, the wheelchair can also be equipped with a range of accessories, such as push handle, side guards or roll stop.

(To see available accessories for this wheelchair, visit www.panthera.se)

For maximum weight of user, see Technical facts

INDICATIONS FOR USE

Panthera mechanical wheelchairs are manually operated multifunctional wheelchairs designed for indoor / outdoor use and intended to provide mobility to persons that have the capability of operating a mechanical wheelchair.

CONTACT















If you have any questions or need help with the product, contact your local supplier (Assistance centre) first. To get in touch with the manufacturer, see the details below:

Panthera AB +46 (0)8-761 50 40
Gunnabogatan 26 www.panthera.se
SE-163 53 Spånga panthera@panthera.se

SYMBOLS

The symbols used in the instructions and on the wheelchair and what they mean are listed below.

Caution: Federal law (USA) restricts this device to sale by or on the order of a physician.

	Caution		Width of Wheelchair Seat
	Consult Instructions for Use		Article Number on the Chassis
	Manufacturer		Article Number on the Label and Revision
	Date of manufacture		Prescription use (USA)
	Serial Number		Medical device
	Catalog Number		CE marking
	Max. wheelchair user weight		Only for indoor use

DESCRIPTION (Fig. 1, 2)

The Panthera Micro 3 models are dynamic wheelchairs designed to let you live life as actively as possible. Meticulous attention has been paid to their every detail. The low weight, combined with the stable, fixed frame and a single caster make the wheelchair extremely easy to manoeuvre.

OVERVIEW (Fig. 1 and 2)



Fig. 1

1. Footrest
2. Chassis
3. Seat cushion
4. Sideguards
5. Backrest/Backrest upholstery
6. Rear wheels
7. Push handle
8. Anti-tip device
9. Quick release
10. Air valve
11. Rear axle
12. Caster
13. Fork
14. Anti-roll device
15. Torso strap



Fig. 2

SAFETY REGULATIONS

Current information

Up-to-date information on safety and product updates can be found at Panthera's website: www.panthera.se

Contraindications

The Micro 3 is always equipped with anti-tip devices for safety.

The Micro 3 is a product specifically for very small

children and their early mobility, and thus per se always (initially) are inexperienced users.

Verify that your wheelchair corresponds with your order:

- Measure the seat width.
- Measure the seat depth.
- Ensure you have received the accessories you ordered.

Conduct a technical inspection of your wheelchair, ensuring that:

- the rear wheel's quick release can easily be shifted in and out of its casings.
- the rear wheel is firmly attached following installation.
- the quick release button springs out fully while in locked position.
- the caster fork can be rotated with ease.



Balance and tipping capacity

What affects the balance and tipping capacity most is the position of the rear wheels and the backrest upholstery adjustment. After adapting your chair, check that you **feel confident about the balance of the chair**.

The tipping capacity of the chair may also be affected if a bag is hung on the backrest, if you lean or stretch backwards, if the tyres have insufficient air pressure or if there is an unexpected change to the surface you are driving on.



Anti-tip device

Panthera wheelchairs are designed to be as manoeuvrable as possible, which means the chair responds quickly and seamlessly to the actions you perform. If you perform the wrong actions you could **tip over in the chair**. If you operate the wheelchair incorrectly and do not have an anti-tip device, there is a risk you may tip backwards.

The anti-tip device is a safety feature that is intended to prevent falling backwards in the wheelchair.

The anti-tip device must always be used on wheelchair model Micro 3 and must be checked daily.

SAFETY REGULATIONS

Wheelchair technique

It is important to test your wheelchair skills and take the time required to hone your wheelchair technique. If you have any questions on wheelchair technique, contact the person who prescribed the chair or your therapist. You are also welcome to get in touch with the team at Panthera AB.

Anti-roll device

Note that the anti-roll device is not designed to be used as a brake. It's designed to keep the wheelchair still while the user makes transfer in or out of the wheelchair or while doing some activity. It also prevents the wheelchair from moving when it's unattended.

Note that it is possible to force the wheels and chair forward even when the anti-roll device is activated.

PLEASE NOTE! In order for the anti-roll devices to function correctly, the tyres must contain the correct air pressure. See technical facts.

The anti-roll devices will operate less effectively if the tyres are worn or contain insufficient air pressure. If changing to a different type of tyre, always check the anti-roll devices as dimensions may vary.



Driving

The reason why the wheelchair is for indoor use and **outdoor use on flat surfaces under adult supervision** only is that it has only one castor (for the wheelchair to turn more easily). This makes the risk higher for the wheelchair to tip over forward when you in high speed run into an obstacle or down in a pit. This could also happen indoor but it is much less common.

Most small children need a torso strap to prevent them to lose their balance and fall out of the wheelchair. A basic strap is included when buying the wheelchair. If this torso strap is not enough, the child should not use the wheelchair until the prescriber has provided one that gives full protection.

Be aware of obstacles like thresholds, where the castor can get stuck and cause a fall forward.

The wheelchair can also be equipped with a push handle to enable the child to be pushed in the wheelchair by an assistant.

Driving on an uneven or inclined surface increases the risk of falling both forward and backwards.

SAFETY REGULATIONS



Lifting while the user is in the wheelchair (Fig. 3)

If the wheelchair is to be lifted while the user remains seated, always grip the chair's chassis. See arrows in Fig. 3.

Do not lift using the push handles, wheels or other movable sections.



Wheelchair technique – Ramps and sloping surfaces

Driving up ramps and sloping surfaces (Fig. 4)

When you are going to drive up a ramp, you need to take a bit of a run-up, keep a steady speed and at the same time control your direction. Lean your upper body forwards and move both rear wheels with fast, powerful pushes.

Driving down sloping surfaces (Fig. 5)

When driving down sloping surfaces and slopes, it is important that you have control over your direction and speed. Lean back and allow the rear wheels to move slowly through your hands. You should be able to stop the wheelchair at any time by grasping the rear wheels.



Warm or cold surfaces

If the wheelchair is exposed to sunshine for long periods, its surfaces may become extremely warm. The wheelchair's surfaces can also become very cold if is stored or used in cold conditions.



Fig. 3



Fig. 4



Fig. 5

SAFETY REGULATIONS



Risk of jamming

While driving the chair, be aware of the risk of your fingers becoming jammed **between the rear wheel and the chassis**, and **between the rear wheel and side guard**.

Ensure your fingers or loose items do not become **trapped in the rear wheel's spokes** while driving. Moreover, take special care to ensure children do not place their hands inside the spokes.

In the attachments between the footplate and the chassis there are openings where there is a risk of entrapment.



Friction burns

There is a risk of burns to the hands and fingers if you brake the wheelchair at a high speed with your hands on the rear wheels, as the friction between the hands and rear wheels generates high heat.

SETTINGS

When adjusting the chair to suit your sitting posture and provide the mobility you require, it is important that you make the adjustments in the correct order.

Firstly, adjust the chair to enable the correct sitting posture. Only then can you adjust the balance of the wheelchair to provide the mobility you require. This must be done in the correct sequence, as adjustments to the sitting posture affect the balance of the wheelchair.

Bear in mind that a little effort adjusting the chair to your requirements initially will be of considerable benefit for a long time to come.

Set aside a day to experiment with alternative settings and see how they feel, to ensure the sitting posture and balance of the wheelchair are just right for you.

Adjustments to the wheelchair's settings must take place in the following order

1. **Seat upholstery**
2. **Foot plate setting**
3. **Backrest and backrest upholstery**
4. **The balance of the wheelchair**
5. **Hip belt**
6. **Push handle**

SETTINGS

1a. The depth of the seat upholstery (Fig. 6)

By moving the seat extender forward or backwards you can adjust the seat depth. Loosen the front part of the seat by pulling it backwards (the seat is attached with velcro). Adjust the seat depth and attach it to the velcro.

1b. The tension of the seat upholstery (Fig. 7)

The rear section of the seat upholstery can be tightened or loosened by adjusting the Velcro strap underneath.

This allows you to vary your seat height by around 2 cm upwards or downwards..

2. The footplate settings (Fig. 8, 9, 10, 11, 12)

The footplate is delivered mounted in "High position, lower" Fig. 8 (the attachment turned upwards Fig. 9 and the footplate mounted in the upper hole Fig. 10)



Fig. 6



Fig. 7



Fig. 8



Fig. 9



Fig. 10

SETTINGS

Raise the footplate

1. Loosen the screws slightly (1) Fig. 11, on both sides, with allen key 4 mm.
2. Adjust the height by sliding the screw in the slot at the footplates attachment (3) Fig. 12 Make sure it is the same height on both sides. To help for this there are markings (4) in the footplates attachments.
3. Tighten the screws (1) Fig 11.

Footplate mounted extra high ("High position upper") Fig. 13

1. Loosen the screws (1) Fig. 11, completely from the nut (2), on both sides, with allen key 4 mm
2. Move the nut (2) Fig. 11 to the lower hole of the footplate Fig. 14 and mount the footplate on the attachment with the screw (1) slightly tighten (1)
3. Adjust the height by sliding the screw in the slot (3) Fig 12 in the footplate. Check that is the same height on both sides. There are marks on the (4) attachment of the footplate for help with this.
4. Tighten the screws (1) Fig. 11.



Fig. 11

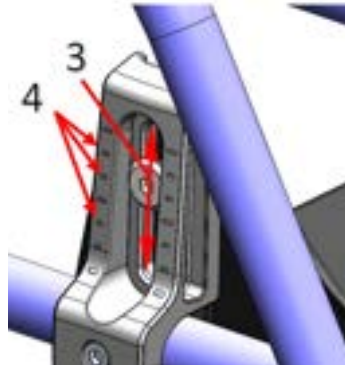

Fig. 12



Fig. 13



Fig. 14

SETTINGS

The footplate mounted low ("Low position, upper") Fig. 15

1. Loosen the screw (1) and nut (2), remove the footplate. Fig. 11
2. Loosen the screw (5) Fig. 16, on both sides, with allen key 4 mm and remove the attachment from the chassis.
3. Rotate the attachment 180° Fig. 17 and mount it on the chassis with the screw (5).
4. With the nut (2) Fig. 11, in the lower hole of the footplate, Fig. 14 mount the footplate to the attachment with the screw (1) Fig. 11 loosely tightened .
5. Adjust the height by sliding the screw in the slot (3) Fig. 12 in the attachment of the footplate. Make sure it has the same height on both sides. There are marks on the (4) attachment of the footplate for help with this.
6. Tighten the screws (1) Fig. 11.



Fig. 15

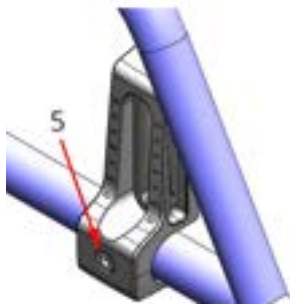

Fig. 16

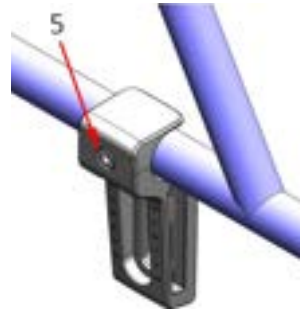

Fig. 17

SETTINGS

Footplate mounted extra low ("Low position lower") Fig. 18

This stage presumes that the attachment is already mounted in "low position", ie the attachment is pointing downwards Fig. 19

1. Loosen the screw (1) Fig. 11 completely from the nut (2), on both sides, with allen key 4 mm.
2. Move the nut (2) Fig. 11 to the upper hole of the footplate Fig. 20 and mount the footplate to the attachment with the screw (1) loosely tightened.
3. Adjust the height by sliding the screw in the slot (3) Fig. 12 in attachment of the footplate. Make sure it is the same on both sides. To help with this, there are markings (4) in the attachments of the footplate
4. Tighten the screws (1) Fig. 11.



Fig. 18



Fig.19



Fig. 20

SETTINGS

3. Backrest and backrest upholstery

Height of backrest (Fig. 21)

First loosen the velcro ribbon to get to the bolts on both sides, see Fig. 21. Then loosen the bolts on both sides. Now you can adjust the backrest to suitable height by sliding the backrest rods up or down. When you have found the desired height, tighten the bolts again. The loose ribbon can be removed if the backrest height is low adjusted.

Tension of the backrest upholstery (Fig. 22)

It is possible to tighten or slack the backrest upholstery by tightening or releasing the Velcro straps on the back of the backrest , see Fig. 22.

The backrest upholstery also has a lower flap fastened with Velcro above the seat upholstery, under the seat cushion. This flap can be moved backwards or forwards to obtain the required tension in the lower section of the back upholstery (known as the seat pocket)

By doing these adjustments you can shape the backrest upholstery after the shape of your back so that you get suitable support for the lumbar region.

Start with slacking the velcro straps and put yourself as far back as possible in the wheelchair.

Then tighten the velcro straps until you get a good support. If you feel that you don't sit as far back as you would like in the wheelchair, it can be that the lower flap of the backrest upholstery is attached to far ahead under the seat upholstery. Then loose this and move it backwards.



Fig. 21



Fig. 22

SETTINGS

4. Balance of the wheelchair Fig. 23

You change the wheelchair balancing by moving the drive wheels (rear axle) forward or backwards, see Fig. 23.

The further forward you place the drive wheels, the more backward balanced the chair becomes. This makes the seat easier to move forward and gives you more weight over the drive wheels. The chair will be easier to maneuver and will also be easier to lift up on the rear wheels than you have to drive over a threshold. However, the chair must not be too back-balanced as it can feel uncomfortable. It is therefore important that you take the time to try out a balance that suits you body and driving technique, so that you really get the seat as easy to drive as possible.

You change the balance like this::

1. Remove the rear wheels.
 2. Loosen the bolts (1) located on the underside of the rear axle attachments, on both sides, see Fig. 23.
 3. Now you can slide the wheel attachments forward or backwards, along the chassis tube. It's important that both wheel attachments has the same position on both sides. Check this by measure the distance **A**, between front of the vertical chassis tube and the rear of the wheel attachments with ruler or similar and check that the distance is the same on both sides, see Fig. 23.
 4. Then tighten the bolts (1) till the rear axle sits firmly.
- The little work you have with adjusting the wheelchair, you get back for a long time ahead. Try different settings during a day to notice if you get the right seating positions and the right balance. After approx. a month make a new check to see that everything is ok.

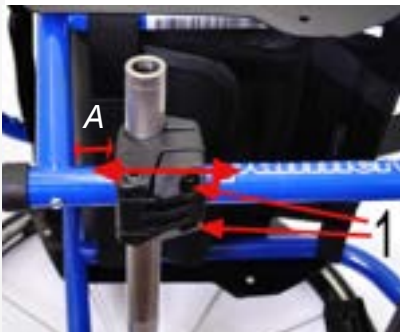

Fig. 23

ACCESSORIES / SETTINGS

5. Torso-strap

Hip belt from third parties that meet requirements according to MDR EU 2017/745 can be used with maintained CE marking. Mounting is done by attaching the straps around the chassis. Allowed areas for attachments, [Fig. 24](#)

6. Push handle [Fig. 25](#)

The push handle is use by the assistant to push the user in the wheelchair. The push handle can be adjusted in height and be folded.

Height adjusting the push handle:

1. Pull out the lever (1) [Fig. 25](#).
2. Now the push handle can be raised or lowered.
3. Fold the lever at the desired height.

Folding the push handle:

1. Push and hold the button on top of the push handle (2) [Fig. 25](#).
4. While pressing the button you can now swing away the push handle.
5. Release the button.

Side guards [Fig. 26](#)

The side guard is mounted into the frame with two screws, allen key 3 mm.



Fig. 24



Fig. 25



Fig. 26

MAINTENANCE

Your Panthera is build to be nearly maintenance free. But a few parts you need to regularly check.

Storage

When storing your wheelchair for 4 months or more you should place it in a dry, warm place. After storage, check the tyre pressure and the condition of the upholstery.

Ongoing maintenance

For the ongoing maintenance you need:

- car schampo or similar.
- degreaser (to remove fat and grease and dirt).
- universal oil, like, CRC 5-56.

Once a month you should:

- Wipe the chassis with car schampo or wash up liquid with a wet cloth. If the wheelchair is heavy soiled degreaser can be used . Grease all moving parts with 5-56, universal oil, after washing.
- Clean the front wheels attachment in the fork (between fork and wheel) Hair and dust often accumulate here which could damage the bearings. Loosen the wheel bolt with allen key 4 mm and remove the wheel. Then clean the distances located between the wheel and fork and wipe the wheel bearings with a cloth. Drip some oil in each bearing. Mount all the details.
- Lubricate the quick release axle for the rear wheel. Remove the rear wheel and put a few drops of oil on the axle.
- Fill the tyres with air. Remove the cap from the valve and open the locking valve and then fill with air with suitable adapter, for correct air pressure, see Technical Facts.
- Check all screws and nuts and tighten them if needed.
- Check the wheelchair for damages. If a damage has occurred please contact us at Panthera AB immediately.

Prevent spread of infection

The whole wheelchair should be whiped of with a cloth soaked with alcohol based antiseptic agent with tenside.

Wash the back rest and seat according to the instructions.

MAINTENANCE

Twice a year you should:

- Lubricate all moving parts with a few drops of oil.
- Wash the seat and backrest upholstery and the cushion cover in 60 °C machine wash if needed.

Attach the velcro together, loop and hock toward each other to avoid tearing the upholstery by the velcro during laundry.

Help with service and repair

For help with service or repair, please contact your local distributor first. You can also contact Panthera for help and answers to questions.

Instructions for reconditioning can be downloaded from www.panthera.se

Replacement of wear parts (Fig. 27 och 28)

Wear parts as tyre and castor can be obtained from your local distributor or be ordered from Panthera AB for payment and the work can be done at home for those who have the opportunity. www.panthera.se

To replace these yourself, do as follows:

To change tyre: (Fig. 27)

- 1) Order parts in the right dimensions.
- 2) Disassemble the rear wheel by pushing the button for the quick release and pull the wheel straight out.
- 3) Disassemble the tyre with suitable tools.
- 4) Mount the tyre carefully to avoid damage. Fill the tyre with air.
- 5) Mount the rear wheel on the wheelchair and be careful to see that the quick release button pops out to lock the wheel in the hub. Grab the spokes and pull the wheel out a few times to check that it is locked. Spinn the wheel and see to that the tyre is mounted correct and that it is completely round.

MAINTENANCE

To change castor

- 1) Order parts in the right dimensions.
- 2) Disassemble the castor with allen key 4 mm.
- 3) When mounting the new castor you hold both bushings with your thumb and index finger and slide the castor into the slots on the fork.

- When reassembling castors after cleaning or servicing, always check that the bolt still has thread lock (blue, red or green) on the thread, which indicates sufficient thread lock. If thread locking is missing, a new bolt must be ordered or light thread lock must be applied

- 4) Tighten with allen key 4 mm. Check that wheel rotates easily.



Fig. 27



Fig. 28

GUARANTEE AND LIFESPAN

Lifespan:

The lifespan of a Panthera product depends on how much wear and tear it is exposed to and how thorough you are with maintenance.

When reaching the end of its lifespan, the wheelchair must be handed in to the local distributor or Panthera AB to be recycled.

Guarantee

Panthera AB offers a five-year factory guarantee on the wheelchair chassis. For other parts there is a guarantee of 12 months (with the exception of wear parts).

- The guarantee covers product faults attributable to defects relating to design, material or manufacturing.
- The guarantee does NOT cover faults attributable to normal wear and tear, negligent maintenance, handling errors, incorrect storage, incorrect assembly on the part of the purchaser, adjustments and use of products from other supplies without obtaining Panthera AB's written consent or deterioration attributable to repairs carried out on the purchaser's own initiative.

Reuse

The Panthera Micro 3 is suitable for reuse. Prior to being reused, the wheelchair must be cleaned, disinfected and dispatched to an authorised reseller for inspection

Marking (Fig. 29 och 30)

The marking of the wheelchair is located at the front of the chassis. See side 3 for explanations of symbols.



Fig. 29



Fig. 30

TECHNICAL FACTS

MICRO 3				
Model code	G515	G515		
Seat width (cm)	24	27		
Total width	46	49		
Total length	63	63		
Total height, 20" rearwheels	55	55		
Seat				
Seat angle	0°	0°		
Seat height rear, 18" rearwheels	30,5	30,5		
Seat height front, 20" rearwheels	33	33		
Seat depth	15-20	15-20		
Back rest				
Backrest height	22-28	22-28		
Backrest angle backward-forward	0°	0°		
Rearwheel diameter	18, 20"	18,20"		
Rearwheel camber angle	10°	10°		
Castor diameter (mm)	90	90		
Measure; Seat to footplate(mm)	95-245	95-245		
Transport measure				
Width	31	34		
Length	63	63		
Height	53	53		
Weights				
Total (g) *	3426	3544		
Transport	2246	2364		
User weight (kg)	30	30		
Airpressure tyre (bar / kPa)	7 / 700	7 / 700		
Material: chassis / backrest	Chrome molybdenium tubing			
Material: upholstery	Polyurethane coated polyester			
Upholstery, cushion:	Fire tested accor. to: ISO 7176-16			
Wheelchair class	B; indoor			
* Weights are measured with anti-tip device and footplate mounted.				

TECHNICAL FACTS

MICRO 3 LONG

Model code	G515	G515		
Seat width (cm)	24	27		
Total width	46	49		
Total length	71	71		
Total height, 20" rearwheels	55	55		
Seat				
Seat angle	0°	0°		
Seat height rear, 18" rearwheels	30,5	30,5		
Seat height front, 20" rearwheels	33	33		
Seat depth	20-25	20-25		
Back rest				
Backrest height	22-28	22-28		
Backrest angle backward-forward	0°	0°		
Rearwheel diameter	18, 20"	18,20"		
Rearwheel camber angle	10°	10°		
Castor diameter (mm)	90	90		
Measure; Seat to footplate(mm)	95-245	95-245		
Transport measure				
Width	31	34		
Length	71	71		
Height	53	53		
Weights				
Total (g) *	3496	3606		
Transport	2316	2426		
User weight (kg)	30	30		
Airpressure tyre (bar / kPa)	7 / 700	7 / 700		
Material: chassis / backrest	Chrome molybdenium tubing			
Material: upholstery	Polyurethane coated polyester			
Upholstery, cushion:	Fire tested accor. to: ISO 7176-16			
Wheelchair class	B; indoor			

* Weights are measured with anti-tip device and footplate mounted.

panthera®



CE

Panthera AB, Gunnebogatan 26, 163 53 Spånga
08-761 50 40, www.panthera.se, panthera@panthera.se