



Salsa R² & Salsa M²

Instructions for Use



000690705

User Information

Intended use power wheel chairs:

Power wheelchairs are exclusively for a user who is unable to walk or has limited mobility, for their own personal use in- and outdoor.

When an Attendant Control Module is fitted, the Power Wheelchair may be operated by an assistant on behalf of the user.

When a Dual Control Module is fitted the Power Wheelchair may be operated by the user, or control may be switched to an assistant to operate on behalf of the user.

The maximum weight limit (includes both the user and any weight of accessories fitted to the wheelchair) is marked on the serial number label, which is affixed to the chassis of the chair.

The chair serial number is affixed also to the front page of the owners manual supplied with the wheelchair.

Warranty can only be taken on if the product is used under the specified conditions and for the intended purposes.

The intended lifetime of the wheelchair is 5 years. Please DO NOT use or fit any 3rd party components to the wheelchair unless they are officially approved by Sunrise Medical.

Area of application

The variety of fitting variants as well as the modular design mean that it can be used by those who cannot walk or have limited mobility e.g. because of:

- Paralysis
- Loss of extremity (leg amputation)
- Extremity defect deformity
- Joint contractures/joint injuries
- Strokes and brain injuries
- Neurological disabilities (e.g. MS, Parkinson...)
- Illnesses such as heart and circulation deficiencies, disturbance of equilibrium or cachexia as well as for elderly people who still have the strength in the upper body.
- Persons who are mentally and physically able to control an input device to operate the chair and its functions in a safe way.

When considering provision, please also note the body size, weight including the distribution of body weight, the user's physical and psychological constitution, the age of the user, their living conditions and their environment. If in doubt a health care professional should be involved to ensure the user is not exposed to unacceptable risks.

Sunrise Medical is ISO 9001 2008 certified, which ensures quality at all stages of the development and production of this wheelchair.



IMPORTANT:

DO NOT USE YOUR WHEELCHAIR UNTIL THIS MANUAL HAS BEEN READ AND UNDERSTOOD.

Sunrise Medical declares under its sole responsibility that this product is in conformity with the requirements of the directive 93/42/EEC amended by 2007/47/EEC."

Sunrise Medical declares that this product fulfils the performance requirements for a "Crash Test" to ISO 7176-19.

1.0 Your Wheelchair	7	7.0 Control System	43
2.0 How to use this manual	7	7.0 R-net control system information	43
2.1 Introduction	7	7.1 VR2 control system information	43
2.2 Guarantee	7	7.2 VR2-L	46
2.3 Warranty conditions	7	7.3 VR2 Dual control unit	47
3.0 Label Explantation / Word definitions	8	8.0 Troubleshooting the VR2 Hand Control	49
3.1 Definitions of words used in this manual	8	9.0 Controller Mounts	51
3.2 Label explanations	9	9.1 General warnings:	51
4.0 General safety warning and user tips	11	9.2 Attendant control:	51
4.1 General warnings	11	9.3 Parallel swing-away control:	51
4.2 Features and options	11	9.4 Centre bar mount control (R-net)	52
4.3 Kerbs	11	9.5 Tray mount control (R-net)	52
4.4 Routine service	11	9.6 Swing-away tray mounted centre control (R-net)	52
4.5 Brake release	11	9.7 Forus control (R-net)	52
4.6 EMC - Radio transmitting devices.	12	9.8 Emergency stop button	53
4.7 Emergency braking	12	9.9 Powered swing away arm (R-net)	53
4.8 Sharp turns	12	10.0 Speciality Controls	54
4.9 Batteries	12	10.1 Proximity head array	54
4.10 Tyres	12	10.2 Driving with the head array (Fig 10.1)	54
4.11 Weight limit	13	10.3 Proportional head control	54
4.12 Wheelchair motors	13	10.4 Sip and puff control and buddy buttons	55
4.13 Hot surfaces	13	10.5 Switch-It mini joystick as a chin control or hand control	55
4.14 Wheelchair range	13	10.6 Proportional chin control (Fig.10.7)	55
4.15 Road use	13	10.7 Micro pilot Joystick	55
4.16 Adverse conditions	14	11.0 Batteries and charging	56
4.17 Ramps	14	11.2 Batteries Salsa M2 (Fig. 11.6 - 11.12)	57
4.18 Transfer to and from the chair	14	11.3 Safety cut-outs	58
4.19 Lift and tilt modules	14	11.4 General battery information	58
4.20 Anti-tips	15	11.5 Maintenance free batteries	58
4.21 Use on a slope	15	11.6 Battery care	58
4.22 Using a vehicle mounted passenger lift	15	11.7 Maintenance free battery care plan	58
4.23 Creep mode	16	11.8 General charger information	59
4.24 Stability of your wheelchair	16	11.9 Charger safety features	59
4.25 Wheels	16	11.10 Connecting the charger and charging	59
4.26 Rear view mirror	17	11.11 Charger safety and caution notes	59
4.27 Crutch holder	17	11.12 The range of your vehicle	60
4.28 Lights and indicators	17	11.13 Common battery statements	60
4.29 Swing away tray	17	11.14 Battery warranty	61
4.30 Using a kerb climber	17	12.0 Transportation	62
4.31 Lap belt (Standard Seat)	19	12.1 Transportation warnings:	62
4.32 Lap strap Rehab Seat	20	12.2 Occupant restraint instructions	63
4.32 VR2 Controller (Fig. 4.21)	21	12.3 Special shipping requirements:	63
5.0 Preparing your wheelchair for use	21	12.4 Crash testing on the SALSA, all models.	64
5.1 Handling the wheelchair	21	12.5 The tie down label and placement	64
5.2 Preparation for transportation or storage	21	12.6 Securing the wheelchair into the vehicle	65
5.3 Re-Assembling	22	13.0 Maintenance and Cleaning	66
5.4 Brake release	22	13.1 Tyre maintenance and pressures	66
5.5 Drive wheel suspension Salsa	24	13.2 Tyre wear	66
5.6 Control joystick unit position	24	13.3 Drive wheel tyre repair	66
5.7 Getting ready to drive	24	13.4 Removing the castor wheel	68
5.8 Standard Armrests	25	13.5 Cleaning your wheelchair	69
5.9 Leg Rests	30	13.6 Inspection of the upholstery/seating	69
6.0 Seating	34	13.7 Cleaning seating	69
6.1 Firm seat board	34	13.8 Cleaning controls	70
6.2 Seat cushions	34	13.9 Lighting maintenance	70
6.3 Removable seat covers	34	13.10 Electrical connections	70
6.4 Backrest upholstery	34	13.11 How to connect the cables to the batteries	70
6.5 JAY backrests	34	13.12 Controller access	73
6.6 Manual angle adjustment of the Rehab fixed back	34	13.13 Storage	73
6.7 Standard Seat width adjustment	34	13.14 Authorised Sunrise Medical service agents	73
6.8 Rehab seat depth	35	13.15 Recommended maintenance routines	74
6.9 Standard Seat height adjustment	35	13.16 Performance checks	75
6.10 Standard Seat Depth Adjustment	36	14.0 Specification sheets	76
6.11 Backrest Angle Adjustment	36	15.0 Service History	80
6.12 Back Height Adjustment	37	16.0 Disposal	80
6.13 Manual adjustable backrest (Standard seat)	39	17.0 SALSA - Salsa M2 Battery Wiring Diagram	82
6.14 Manual setting of the seat angle on the SALSA	39		
6.15 Manual adjustable backrest (manual recline Rehab Seat)	40		
6.16 JAY backrests	40		
6.17 Headrest	40		
6.18 Powered Seating	41		

SALSA R²



Salsa M²



Salsa M² COMFORT SEAT



Dealer signature and stamp

1.0 Your Wheelchair

We at Sunrise Medical want you to get the best out of your SALSA wheelchair. This Owner's Manual will familiarise you with the chair and its features. It contains hints on everyday usage and general care in addition to information on the high quality standards which we adhere to and details about the guarantee.

Your wheelchair should be delivered fully configured for your use; there are a wide range of components and adjustments available on the SALSA. For further information about these you should contact your Sunrise Medical authorised dealer.

Your wheelchair will reach you in excellent condition having been personally inspected before leaving our factory. Following the guidelines for maintenance and cleaning your wheelchair will maintain its first class condition and give you complete satisfaction. The SALSA has been designed for use by an individual on a daily basis. It is suitable for both indoor and outdoor use (Class B). It is only intended for use as a pavement vehicle, but may also be used when crossing between pavements.

This vehicle has been designed for a single occupant of limited mobility up to the weight of 140Kg (dependant on options chosen for your chair).

NOTE: up to 160kg user weight with Salsa R2 and Rehab seat.

The end user must have the cognitive, physical and visual ability to control the vehicle safely on a maximum slope of 14% (8°). If you are in any doubt as to the suitability of the power chair, contact your local Sunrise Medical approved supplier for clarification, prior to commencing use.

It is very important to read the relevant section of the owner's manual when making any minor adjustments. Consult the Technical Manual or your local Sunrise Medical authorised dealer for more complex adjustments.

If you have any queries about the use, maintenance or safety of your wheelchair, please contact your local approved Sunrise Medical service agent. If you do not know of an approved dealer in your area or have any other questions please write or telephone:

Sunrise Medical
Thorns Road
Brierley Hill
West Midlands
DY5 2LD
Phone: 0845 605 66 88
Fax: 0845 605 66 89
www.SunriseMedical.co.uk

2.0 How to use this manual

2.1 Introduction

Please keep a note of your local service agent's address and telephone number in the space below.

In the event of a breakdown, contact them and try to give all relevant details so they can help you quickly.

The wheelchairs shown and described in this manual may not be exactly the same in every detail as your own model. However, all instructions are still entirely relevant, irrespective of detail differences.

NOTE: The manufacturer reserves the right to alter without notice any weights, measurements or other technical data shown in this manual. All figures, measurements and capacities shown in this manual are approximate and do not constitute specifications.

2.2 Guarantee

The guarantee form is included in the Sunrise Pack. Please fill in the relevant details and return to us to register your entitlement.

THIS IN NO WAY AFFECTS YOUR STATUTORY RIGHTS.

2.3 Warranty conditions

- 1) The repair or replacement will be carried out by an authorised Sunrise Medical dealer/service agent.
- 2) To apply the warranty conditions, should your wheelchair require attention under these arrangements, notify the designated Sunrise Medical service agent immediately giving full information about the nature of the difficulty. Should you be operating the wheelchair away from the locality of the designated Sunrise Medical service agent, work under the "Warranty Conditions" will be carried out by any other service agent designated by the manufacturer.
- 3) Should any part of the wheelchair require repair or replacement, as a result of a specific manufacturing or material defect, within **twenty four months** from the date on which the possession of the wheelchair was transferred to the original purchaser, and subject to it remaining within that ownership, the part or parts will be repaired or replaced completely free of charge if returned to the authorised service agent.

4) Any repaired or replaced part will benefit from these arrangements for the balance of the warranty period applicable to the wheelchair.

5) Parts replaced after the original warranty has expired are covered for a further twelve months.

6) Items of a consumable nature will not generally be covered during the normal warranty period, unless such items have clearly suffered undue wear as a direct result of an original manufacturing defect. These items include amongst others upholstery, tyres, inner tubes and similar parts. On powered products this will also include batteries, motor brushes etc

7) The above warranty conditions apply to all wheelchair parts for models purchased at full retail price.

8) Under normal circumstances, no responsibility will be accepted where the wheelchair has required repair or replacement as a direct result of:





a) The wheelchair or part not having been maintained or serviced in accordance with the manufacturer's recommendations, as stated in the Owner's Manual and/or Service Manual. Or failing to use only the specified original equipment parts.

b) The wheelchair or part having been damaged by neglect, accident or improper use.









c) The wheelchair or part having been altered from the manufacturer's specifications, or repairs having been attempted prior to the service agent being notified.







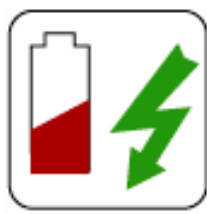



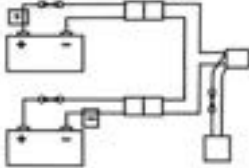

3.0 Label Explantation / Word definitions

3.1 Definitions of words used in this manual

Word	Definition
 DANGER!	Advice to the user of Potential Risk of serious injury or death if the advice is not followed
 WARNING!	Advice to the user of a potential risk of injury if the advice is not followed
 CAUTION!	Advice to user that potential damage to equipment may occur if the advice is not followed
NOTE:	General advice or best practice
RWD	Rear Wheel Drive
MWD	Mid Wheel Drive
	Reference To Additional Documentation

3.2 Label explanations

	
<p>Lever position for the LEFT-HAND freewheel mechanism Salsa M² (& SALSA from August 2010). Tick = IN DRIVE, Cross = IN FREEWHEEL</p>	<p>Lever position for the RIGHT-HAND freewheel mechanism Salsa M² (& SALSA from August 2010). Tick = IN DRIVE, Cross = IN FREEWHEEL</p>
	
<p>WARNING – Do Not Touch - HOT</p>	<p>Attached to Joystick WARNING – Do not drive your wheelchair on a slope with the backrest reclined and/or the seat lifted</p>
	
<p>WARNING – Danger of finger entrapment</p>	<p>WARNING – Maximum user weight for the chair is 140Kg or *160kg for Salsa R² with Rehab Seat</p>
	
<p>The serial number and information label is located on the front right hand side of the main frame.</p>	<p>Indicates battery charge point</p>
	
<p>Crash Tested / Tie down points</p>	<p>WARNING – Do Not Touch - Static may damage equipment</p>

Labels and their descriptions	
 	
Battery Label – Warning Instructions and Circuit Diagram	
	
Back Rest Recline	Seat Lift
	 
Seat Tilt in Space	The power Tilt and power Lift/Tilt modules are factory fitted for optimum stability and for conformance to strict standard requirements. Changing the fitted position of the module can reduce the stability of the product, therefore do not change this setting
 Left Leg Rest  Right Leg Rest  Both Leg Rests	  
	
Do not engage Brake release whilst on a slope	Ensure drive is engaged before starting off.

4.0 General safety warning and user tips

4.1 General warnings

WARNING!

- Always ensure that your wheelchair is switched off before attempting to transfer in or out.
- Always ensure that you are able to operate all controls from a comfortable position. Paying attention to your posture is essential to ensure your continued comfort and well being.
- Always make sure that you can be seen clearly, especially if you intend using your wheelchair in poor light.
- This wheelchair has been built to match the needs of a particular user. If used by another user then it may need to be adjusted and reprogrammed.
- Do not let children or others use your wheelchair.
- Be aware that the wheelchair may come to a sudden stop during operation. Sunrise Medical recommend that a lap strap be worn at all times.
- Do not operate the wheelchair if it is behaving abnormally or erratically.

4.2 Features and options

NOTE: Some of the options shown in this manual may not be available in your country and may also restrict the overall physical limits of the standard product (e.g. max. speed, user weight limit, etc.). Those limitations are marked on the order form, in the technical manual and in this owner's manual. For further information please consult your Sunrise Medical authorised dealer.

4.3 Kerbs

DANGER!

- Never descend a kerb Forwards with a RWD chair or Backwards with a MWD chair. Please read carefully the section 4.30 on kerb climbing in this manual before attempting to mount and dismount any kerbs in your wheelchair.
- Do not attempt to climb or descend a series of steps. It is unsafe to do so and could cause personal injury or damage the chair. The SALSA R² & Salsa M² has only been designed to climb a single step or kerb.
- We recommend that users with upper trunk instability wear further customised restraint systems to keep the upright body position during descending or ascending ramps, curbs or obstacles.

4.4 Routine service

The recommended service interval is one year. (See service history table, section 14, Fig.14.1).

4.5 Brake release

DANGER!

- The Brake release, (freewheel), is only to be used in an emergency power breakdown situation e.g. Where a large distance has to be covered to get the user home or into a safe environment.
- Brake release can also be used if a complete and catastrophic loss of power such as control system failure or battery failure has occurred.
- Brake release should not be habitually used as a means of transporting the user as if in a manual chair.
- When the power chair is functioning normally, the brake release should only be used to park or store the unoccupied wheelchair.

Please remember that you have no braking facility when the Brake release, (freewheel), levers are moved from the normal drive position to the freewheel position, Fig. 4.1, Fig 4.2, (Salsa M²); Fig 4.3 and Fig 4.4 SALSA R²).

DANGER!

- Always ensure an attendant is with you when bringing the chair into the freewheel mode.
- The wheelchair must never be left with one or both levers in the freewheel position.

For an enhanced description of this facility and its limitations to use, please see later section at 5.4.



4.6 EMC - Radio transmitting devices.



WARNING!

When operating two-way radio, walkie-talkies, C.B., amateur radio, public mobile radio and other powerful transmitting devices the wheelchair should be brought to a halt and turned off.

The operation of cordless, mobile telephones and cell phones including hands-free devices is permitted but if abnormal operation of the wheelchair is encountered then the chair must be brought immediately to a halt and turned off.

NOTE: the electrical systems of the wheelchair may disturb the performance of alarm systems in retail shops.

4.7 Emergency braking

There are three ways to stop your wheelchair:

1. Simplest and safest way to stop the wheelchair is to release the joystick (see Hand Control section 7). This will bring the chair to a halt in a controlled manner.
2. Pulling back the joystick will brake the chair abruptly with a fast stop
3. Switching the control system off whilst the chair is in motion will also bring the chair to a halt.



WARNING!

- Switching the control system off is only to be used in an emergency situation as the stopping action is very abrupt.
- Sunrise Medical recommend the use of a lap strap at all times.

4.8 Sharp turns



DANGER!

Full speed turns should not be attempted. If you need to turn sharply you must reduce your speed with the joystick or speed setting. This is particularly important when travelling across or down a slope. Disregarding this advice could lead to your wheelchair tipping over.

4.9 Batteries

Your wheelchair is supplied as standard from Sunrise Medical with maintenance-free batteries. These only require regular charging. Before charging, please read [section 11](#) in this manual.



WARNING!

Do not, under any circumstances, tamper with the batteries. If in any doubt contact your local Sunrise Medical authorised dealer.



CAUTION!

Before using your vehicle for the very first time, please charge your batteries for a period of 24 hours.



WARNING!

Avoid contact with acid on damaged sealed type batteries or wet batteries. Battery acid can cause burns to the skin as well as damage to floors, furniture and your wheelchair. If it comes into contact with the skin or clothing, wash immediately with soap and water. If it comes into contact with the eye, immediately flood the eye with running cold water for at least 10 minutes and seek medical attention immediately. Acid can be neutralised with baking soda and water. Take care to keep batteries upright at all times, especially when transporting your wheelchair.

Battery and charger connector type Salsa R2:
24V (2x12V) / 60 Ah/20h. Maintenance free
Dimensions: 197 x 165 x 197 mm.

Connector: 3 pins "Neutrik" type

4.10 Tyres

Your wheelchair tyres can wear depending on use. Check them regularly in accordance with the service instructions in this manual, especially the pressure of the tyres.



DANGER!

Never inflate the tyres using a garage forecourt airline, always use the pump provided.

4.11 Weight limit



- The user plus items carried should never exceed a total weight of 140Kg, (160Kg Salsa R² Rehab Seat).
- Never use this chair for weight training if the total weight (user plus additional weights) exceed a total weight of 140Kg.
- Exceeding the weight limit is likely to damage the seat, frame or fasteners and may cause severe injury to you or others from chair failure
- Exceeding the weight limit will void the warranty.

4.12 Wheelchair motors

After prolonged use, the motors will produce heat, which is radiated through the motors' outer casing.



Do not touch the motors' outer casing for at least 30 minutes after using the wheelchair, to allow it to cool. Fig. 4.6.



4.13 Hot surfaces

Not only the motors can get hot during the operation of the chair, but also the upholstery material and armrests when standing in the sun.

4.14 Wheelchair range

The range of your wheelchair can be affected by many factors such as user weight, terrain, ambient temperature, use of powered options and battery condition.

NOTE: The stated range in the sales literature should be seen as the theoretical maximum (ISO 7176; Part 4) and may not be attained by every user (also see section 10.11 and section 13, in this manual).

We recommend that every user initially limit their journey to half the stated range, until they have confidence in the actual range their wheelchair can attain.



If your battery indicator is showing a low charge then do not attempt a long journey unless you are confident in reaching your destination and also returning to your home without the risk of being left stranded.

4.15 Road use

Please show the utmost consideration for the other traffic on the road.



Remember that the last thing a car or lorry driver expects to see is a wheelchair backing off the kerb into the road. If in any doubt, do not risk crossing the road until you are certain that it is safe. Always cross the road as quickly as possible; there may be other traffic.

4.16 Adverse conditions

Please be aware that when driving your wheelchair in adverse conditions, e.g. on wet grass, mud, ice, snow or other slippery surfaces, you may experience a reduction in the grip and traction of your wheelchair.

WARNING!

We recommend you take extra precautions in these conditions, particularly on hills and slopes; your wheelchair could become unstable or skid causing possible injury.

NOTE: Extreme variances in temperature may trigger the self protect mechanism in the control system. If this occurs the control system will temporarily shut down to prevent damage to the electronics or the chair.

DANGER!

When you are using a Powered Scooter or Wheelchair, take extra care with loose or long items of clothing. Moving parts, such as wheels, can be potentially dangerous or even fatal if clothing becomes entangled.

4.17 Ramps

WARNING!

When using a ramp, please ensure that it is capable of taking the combined weight of the power chair and yourself. If a ramp is being used to load a chair into a vehicle, please ensure the ramp is properly secured to the vehicle.

Always approach the ramp head-on and exercise caution.

CAUTION!

Please ensure your ramp is suitable for the product you are transporting.

4.18 Transfer to and from the chair

WARNING!

- Sunrise Medical recommend that you consult your health care professional for assistance in developing your personal front or side transfer technique to best suit your needs and avoid any personal injury.
- Ensure controller is switched off during transfers to avoid unintentional movement.
- If a reclining arm rest is fitted, please ensure that the reclining support bar is secured into the recline receiver that is attached to the seat frame.

4.19 Lift and tilt modules

WARNING!

Please be aware that the lift and tilt modules present a trap hazard. Make sure that when operating the tilt and lift it is free from all clothing, hands, feet and other extremities to prevent injury.

WARNING!

- Do not drive on ramps or slopes with the seat tilted, reclined or raised. Before attempting to climb or decline a slope, return to an upright position
- The power Tilt and power Lift/Tilt modules are factory fitted for optimum stability and for conformance to strict standard requirements. Changing the fitted position of the module can reduce the stability of the product, therefore do not change this setting.

WARNING!

Risk of trapping fingers:

The optional protection guard if fitted, secures the moving parts within the lift / tilt mechanism. Although better protected, always be careful not to get your fingers trapped in the mechanism. It is recommended to re-install the protection guard as described in the Salsa technical manual after any service or repairs to the lift / tilt module. Please consult your approved Sunrise Medical Dealer.

4.20 Anti-tips

WARNING!

- Make sure that anti-tips are not damaged or worn before using your chair.
- Attendants must be aware of the location of the anti-tips to prevent feet being trapped underneath causing injury.
- Attendants - Do not stand on the anti-tips, this could cause the wheelchair to become unstable.

4.21 Use on a slope

Your wheelchair has been designed and tested to allow its use on slopes or gradients of up to 8° (14%). However, you have the option of adjusting your seating position with either a lift, tilt or recline or a combination of these options.

WARNING!

In certain circumstances your wheelchair could become unstable. Before attempting to climb or descend a slope or a kerb, caution should be taken when using weight shift options (e.g. powered tilt or recline) of the seat and/or your body for a counter balance weight. To improve stability lean forward when driving uphill, with the seat and back in an upright position. Alternatively sit in an upright position when travelling in a forward, downhill direction or tilt and/or recline the seat backwards.

WARNING!

We strongly recommend that you return the seat and back to an upright lowered position before attempting to climb or descend a slope. Failure to do this may cause the wheelchair to become unstable.

WARNING!

If you are in any doubt about the capabilities of your wheelchair on a slope then do not attempt to drive up or down the slope/kerb; try to find an alternative route.

4.21.1 Gradients: ascents

WARNING!

When going uphill, keep the chair moving. Steer by moving the joystick from side to side. If you have stopped on a hill, you should start slowly. If necessary lean forward to prevent the tendency for the front wheels to lift.

4.21.2 Gradients: descents

WARNING!

On descents, it is important not to let the wheelchair accelerate beyond its normal level of ground speed. In fact, it is safer to proceed slowly down steep descents (below the speed of 5kph) and stop, if any anxiety arises regarding directional control. If the chair picks up speed, centre the control to slow it or to stop all forward movement, then restart slowly and do not allow the speed to increase.

NOTE: The solid state controller has the benefit of a logic system that will help compensate when driving along a camber or up a hill. This is an added safety feature on your wheelchair. In addition of course, you may control the wheelchair speed by using the speed control.

4.22 Using a vehicle mounted passenger lift

Wheelchair lifts are used in vans, buses and buildings to help you move from one level to another.

DANGER!

- Ensure that the user and all carers fully understand the lift manufacturer's instructions for using the passenger lift.
- Never exceed the lift manufacturer's recommended safe working load and load distribution guidance.
- Always turn off all power when you are on the lift. If you fail to do so, you may touch the joystick by accident and cause your chair to drive off the platform. Be aware that a rollstop at the end of the platform may not prevent this.
- Always position the user securely in the chair to help avoid falls while on the lift.
- Always ensure the chair is in drive mode when using passenger lift (wheels locked not in freewheel mode).

4.23 Creep mode



Please ensure your backrest recline angle relative to floor level, which is a combination of the back recline itself and the tilt angle, does not exceed 12° to drive the chair safely.

NOTE: If the tilt angle exceeds 9° the chair will the chair will automatically convert into “creep mode” which will allow you a maximum of 10% of the speed programmed in the profile.



If you have a manual recline backrest on your wheelchair, please be aware that there will be no feedback system to the controller that tells it that the seat is in a reclined position. If you recline your backrest and attempt to drive, it will not go into ‘creep mode’, it will instead drive at normal speed. This is especially dangerous when attempting to drive up a slope.



On any Reclining Backrest, the Lower fixing positions of either the Powered Actuator or Manual Gas Strut, MUST correspond to the Seat Depth being used. After adjusting the Seat Depth, you MUST ensure the lower Actuator or Gas Strut fixing position matches the Seat Depth chosen, (use the 17”, 430mm, hole position in the lower bracket for a seat depth of 17”, 430mm). Please see section 5.2.1 for details.

4.24 Stability of your wheelchair

Please follow the user instructions in this manual regarding the use of seat lift and tilt modules and the use of your chair on a slope.



Other variables can affect your chair stability, including:

- Movement of the user
- Effects of the addition of accessories or other equipment
- Inappropriate adjustments or modifications to the wheelchair

In some cases these issues are further compounded by the effects of the local environment such as:

- Hills, Slopes, Ramps, Sloping pavements, Dropped kerbs.

Furthermore different body proportions of a wheelchair user affect stability for example:

- Lower limb wasting or amputation, Obesity
- Increased upper torso mass, Upper torso height



The power Tilt and power Lift/Tilt modules are factory fitted for optimum stability and for conformance to strict standard requirements. Changing the fitted position of the module can reduce the stability of the product, therefore do not change this setting.

4.25 Wheels



- Always use the pump that is supplied with the chair.
- Never use a forecourt pump.
- Inspect all tyres regularly for signs of wear.
- Do not drive over anything that could cause punctures in the tyres.
- Ensure that there are no objects in your path that could possibly become lodged in your chair mechanism or in the spokes of the rear wheels. This could cause the chair to come to a sudden stop.
- Riding over drains or grids could cause the wheelchair castors or wheels to become lodged, causing the chair to come to a sudden stop.
- Always maintain the correct pressure for the tyre. These are listed in section 12 of this manual.



Pneumatic Tyres with OKO fluid.

The OKO fluid is only meant as a temporary repair to the tyre. It must be replaced or repaired as soon as possible.

First Aid measures for OKO fluid

Skin - Wash skin with plenty of water

Eyes - Immediately flood the eye with plenty of water for at least 5 minutes holding the eye open.

Ingestion - Drink lots of water - Seek medical attention immediately.

The OKO fluid is classified as non hazardous but may cause irritation to the skin with prolonged contact.

4.26 Rear view mirror

WARNING!

To avoid injury to people around you please be aware that the mirror protrudes outside the space envelope of the chair and could cause injury to someone when driving past.

The mirror must be used on the 10KPH model on UK roads.

Always make sure that when using the mirror that it is clean and unbroken so that it does not impair your visibility.

4.27 Crutch holder

WARNING!

- Make sure that the crutch is securely fastened to the crutch holder.
- Make sure that the crutch is not interfering with the mechanisms of the chair.
- Make sure that the crutch does not protrude from the chair.
- Do not attempt to remove the crutch whilst the chair is in motion.
- Always come to a complete stop and turn off the power to the controls before attempting to remove the crutch. This will avoid accidentally operating the chair.

4.28 Lights and indicators

WARNING!

Ensure that the lights and indicators are functioning correctly and lenses are clean before going outdoors at night. Light assemblies can become very hot - Care must be taken if removing them for repair.

4.29 Swing away tray

WARNING!

- The maximum weight allowed for the tray is 2.5kg.
- Do not overload the tray, this could cause the tray to break or could cause the chair to become unstable.
- Do not leave lit cigarettes or other heat sources on the tray as this could cause the tray to deform and mark.
- Ensure that all extremities and clothing are free when positioning the tray for use.

4.29.1 Seat stay

A seat stay is provided on your powerchair to provide access for service and maintenance. (see section 10 for additional information)

WARNING!

Do not move the wheelchair with the seat stay in place and make sure you are on flat stable ground.

4.30 Using a kerb climber

WARNING!

Ensure there are no people or other obstacles in your path when mounting a kerb or step.

4.30.1 Mounting a kerb or step

WARNING!

Always approach a kerb at 90°

Approach the kerb (step) head on driving forwards slowly and steadily and always at a 90° angle, (Fig.4.7).

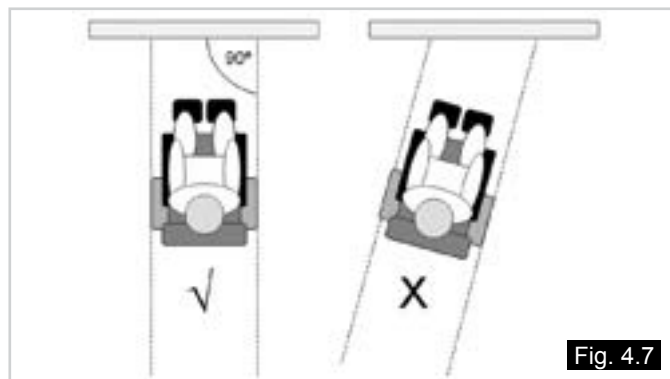

Salsa R2 (RWD)

As the kerb climber or castor makes contact with the kerb (step), the wheelchair should be moving slowly. Small kerbs can be climbed from a standstill, (Fig.4.8 - 4.9).

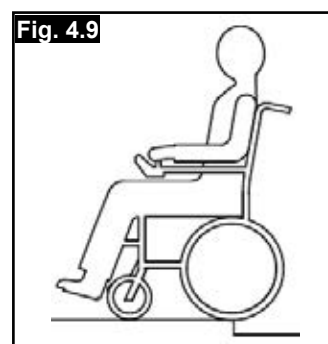

Salsa M2 (MWD)

Approach the kerb in a 90° angle and stop the chair as soon as the castor wheels touch the kerb.

Apply sufficient power to the motors to lift the front of the chair up onto the kerb (step) and then apply slightly more power and speed so that the drive wheels climb the kerb (step) smoothly and without hesitation and the rear castor wheels come up as well. As far as possible, keep the joystick in the straight forward position, (Fig.4.10 - 4.11).



Note: In accordance to the ground clearance, the maximum obstacle height possible to climb is 5 cm (10 cm with kerb climber) for Salsa R2 and 7.5 cm for Salsa M2.

WARNING!

The approach speed and process can vary depending on your wheelchair performance and castor wheel choice.

4.30.3 Kerb climber fitting and removal procedure (RWD base only)

- Locate the kerb climber bar into the left hand location bracket and push it into the right hand receiver bracket, (Fig.4.12 & Fig.4.13).
- Hold the kerb climber with your left hand in the receiver bracket.
- Align the holes of the receiver bracket and the kerb climber tube and plug in the locking pin from the top.
- Reverse the procedure to remove the kerb climber.



WARNINGS!

1. Please show the utmost consideration for the other traffic on the road. Remember that the last thing a car or lorry driver expects to see is a wheelchair backing off the kerb into the road. If in any doubt, do not risk crossing the road until you are certain that it is safe.
2. Always cross the road as quickly as possible; there may be other traffic.
3. Do not attempt to go up or down more than a 10 cm (4") high kerb (Salsa R2 only with kerb climber fitted).
4. Do not attempt to use the kerb climber on a series of steps.
5. Do not attempt kerbs if on steep slopes or cambers.
6. Do not attempt any kerbs in the vicinity of drain covers, uneven or gritty road surfaces.
7. Do not mount or dismount kerbs at an angle other than straight on (90 degrees) to the edge of the kerb.
8. Prior to climbing ensure your legrests will clear the kerb.
9. Take care of the anti-tips which might interfere with the kerb or the ground when mounting or dismounting a kerb.

WARNING!

This wheelchair is designed to be repaired and assembled by a Sunrise Medical authorised dealer and not the end user. The end user has to disassemble and assemble the chair only for transportation (see section 5.2).

4.31 Lap belt (Standard Seat)

The lap belt kit. (Fig. 4.14).

Fastening the lap strap:

Insert the 3 prong male buckle into the female buckle until a click is heard (Fig. 4.15)

To fit the lap strap.

- Place the strap loosely across the seat with the buckle closed.. (Fig. 4.16)
- Pass the other ends of the strap through the gap between the backrest posts and the backrest upholstery as shown. (Fig. 4.17)
- Ensure that the adjusters & buckles can be accessed & the strap is not twisted. Fit the eyelet over the rearmost bolt. Fit the plain washer, sprung washer & nut. Tighten with a 13.0mm spanner. Repeat for the other side. (Fig. 4.18)
- Ensure that the lap strap is tight enough to provide comfortable support. A simple measure is to keep a hands thickness between the body and lap strap. For safety, check the tension on the lap strap at least once day. (Fig. 4.19)
- Generally, the lap belt should be fixed so that the straps sit at an angle of approximately 45° (Fig. 4.20), and when correctly adjusted should not allow the user to slip down in the seat.

WARNING!

- Ensure that the lap belt is secured and correctly adjusted before use.
- An incorrectly fitted/adjusted lap belt could allow the user to slip down, potentially causing serious injury.
- Inspect the lap belt at regular intervals for any signs of fray or damage and replace as necessary.
- When servicing, check for correct operation of the release buckle and for any signs of wear on the material or plastic brackets.

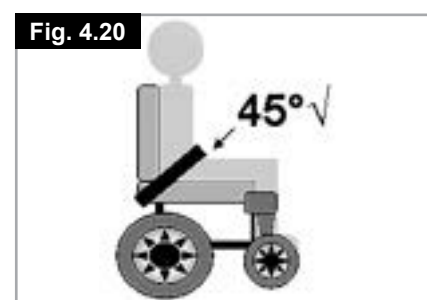

4.31.1 Lap strap Rehab Seat

The 5 cm (2") Aircraft Buckle lap strap. (Fig. 4.6).



The 5 cm (2") Aircraft Padded Lap strap. (Fig. 4.7)



The lap strap fitted for a right-handed user. (Fig. 4.8)



The lap strap fitted for a left-handed user. (Fig. 4.9)



Place the strap loosely across the seat with the opening end of the buckle facing to the right for a left-handed person and to the left for a right-handed person. (Fig. 4.10)



Pass the other ends of the strap through the gap between the backrest posts and the backrest upholstery as shown above. (Fig. 4.11)



Feed the bracket ends of the straps under the backrest brace bar as shown, using the lower fixing hole. Ensure that the adjuster buckles can be accessed and the strap is not twisted, (Fig. 4.12).



Put a washer on the bolt. Pass the bolt through the lap strap fixing bracket. Put the next washer on to the bolt, (Fig. 4.13).

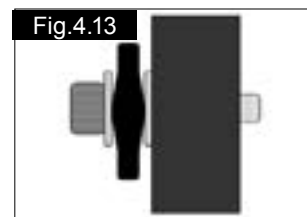

Screw the bolt into the lowest pre-drilled hole in the frame. (Fig.4.14)



Tighten using a 5.0mm hex wrench to a torque value of 10Nm, (Fig.4.15).



Adjust the lap strap to suit, leaving no more than a hand's width gap for comfort and safety.

The hand clearance should be with the lap strap under normal tension and not allow large gaps or loops, (Fig. 4.16).



Generally, the lap strap should be fixed so that the straps sit at an angle of approximately 45° (Fig. 4.17), and when correctly adjusted should not allow user to slip down in the seat.

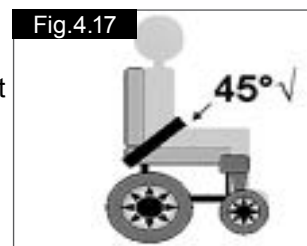

DANGER!

- Always make sure that the lap strap is correctly secured and adjusted prior to use.
- Too loose a strap could cause the user to slip down and cause serious injury.
- Check lap strap and securing components at regular intervals for any signs of fray or damage. Replace if necessary
- When servicing, check for correct operation of the release buckle and for any signs of wear on the material or plastic brackets.
- Lap straps are not suitable for transit purposes, approved occupant restraint systems must be used.

NOTES:

1. Standard Sling - Lap strap movement is restricted by upholstery
2. Contoured back - Use universal bottom bracket as per recline back method

4.32 VR2 Controller (Fig. 4.21)

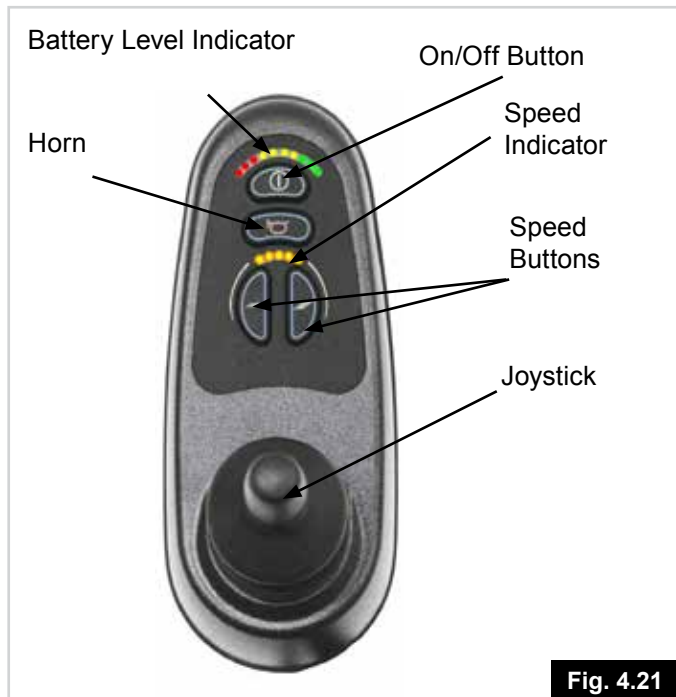

Fig. 4.21

WARNING!

- Avoid knocking your control system and especially the joystick.
- Be careful not to strike obstacles with the control system or joystick when you drive.
- Never drop the control system.
- When transporting your wheelchair, make sure that the control system is well protected.
- Avoid damage to cables.
- To improve the reliability of the control system keep exposure to extreme conditions to a minimum.
- Do not expose your control system or its components to damp for prolonged periods.
- If your control system becomes contaminated with food or drink clean it off as soon as possible.

DANGER!

- In the event of the wheelchair moving in an unexpected way **RELEASE THE JOYSTICK**. This action will stop the wheelchair under any circumstances
- Do not operate the control system if the wheelchair behaves erratically or shows abnormal signs of heating, sparks or smoke. Turn the control system off at once and consult your Sunrise approved dealer.



R-net Control

Please refer to your R-net Owner's Manual for details.

5.0 Preparing your wheelchair for use

5.1 Handling the wheelchair

NOTE: To dismantle the chair for transport or storage no tools are required.

List of components when dismantled (components below are related to the maximum detachable parts and dependent on the type of seating system chosen):

- 1 pair of armrests
- 1 pair of legrests, (Standard Seat), or single centre mount leg rest with flip-up footplate, (Rehab Seat).
- 1 backrest, (Standard, Jay/ Jay Comfort)
- 1 drive unit with seat frame

5.2 Preparation for transportation or storage

Standard Seat.

First remove the swing-away legrests. Leave the armrests in the fold down position. (Fig.5.1). Disconnect the Hand Control, (Fig.5.2), if necessary. To remove the control pod you have to access the motor controller through the plastic cover between the castor wheels and remove the square remote control connector.

Place the control pod & arm in a safe place until required. To reconnect the hand control just use the process in reverse. Release and lift off the backrest at the frame, (Fig.5.3). Now you can store the chassis part.

Rehab Seat

First remove the leg rests if swing away leg rests are attached. In the case of a centre mount leg rest, just flip up the footboard. Lift off the armrests (Fig. 5.5), disconnect the hand control if necessary, (Fig.5.7-5.8). Release the retainer pin and fold down the backrest at the frame (Fig. 5.6R). Now you can store the chassis part. By releasing the freewheel mechanism (Fig. 5.5 RWD-FWD and Fig. 5.6 MWD) on the left and right side of the chassis you can move the drive unit as close as possible to the place you want to store it.

You can also drive the base with the joystick up or down a ramp into and out of a car for transportation.

By releasing the freewheel mechanism on the left and right side of the chassis you can move the drive unit as close as possible to the place you want to store it. You can also drive the base with the joystick up or down a ramp into and out of a car for transportation.

NOTE: See overleaf for figures

⚠️ WARNINGS!

- Make sure, when the chair is stored or left in the car or anywhere else, the controller is switched off and the freewheel mechanisms are engaged.
- If there is a need to lift the drive unit the big side frame tubes should be used.
- On the MWD use the rear castor arm and the drive wheel. Caution should be taken if the chair is in freewheel.

To remove the control pod:

VR2: Loosen the adjustment screw on the control arm and slide the arm out of the bracket, (Fig 5.7). Place the controller and arm in a safe place until required.

R-net: Locate the in-line bus connector. Gently pull the plugs apart to separate the loom, (Fig. 5.8). To reconnect the hand control just repeat the process in reverse.

5.3 Re-Assembling

Flip up, (Rehab), or replace, (Standard), the backrest into the receivers and tighten the lever screws carefully. If required reconnect the remote controller. Attach the hangers. Make sure your freewheel mechanisms are engaged. Now you are ready to drive the chair.

⚠️ WARNING!

- Never lift the wheelchair by the armrests or the leg rests, since they are detachable and harm could be done to the user or to the wheelchair.
- The wheelchair is not designed for use with a hoist, (Fig.5.4)

5.4 Brake release

⚠️ DANGER!

- The Brake release is only to be used in an emergency power breakdown situation e.g. Where a large distance has to be covered to get the user home or into a safe environment.
- Brake release can also be used if a complete and catastrophic loss of power such as control system failure or battery failure has occurred.
- Brake release should not be habitually used as a means of transporting the user as if in a manual chair.
- When the power chair is functioning normally, the brake release should only be used to park or store the unoccupied wheelchair.
- Never push the occupied power chair up or down a slope with the Brake release in operation.

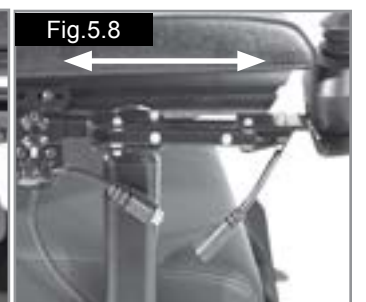

SALSA R² & M² Below-from August 2010 (Fig.5.9 - 5.11)
By rotating the red lever outwards on both sides of the motor the brakes are released from the motors.

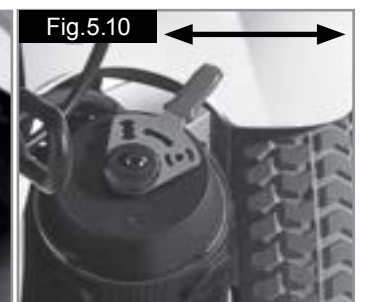
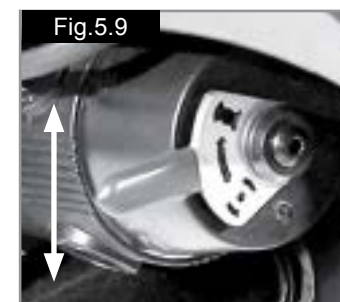

Please ensure the controller is switched off before you engage the release levers – Failure to do so will increase the force needed to push the chair.

DANGER!

- This may only be used in an emergency, or if you need to manually push your wheelchair. It is not intended for permanent use or to push the wheelchair up/down a slope with the user sitting in it.
- The chair's automatic braking system will not work unless the brake release levers are in the "drive" or down position.
- Motor surfaces can be hot after use. Be careful not to touch the motor casing when disengaging the freewheel.
- Never attempt to disengage the brake release mechanism whilst sitting in the wheelchair, especially on a slope.
- Always ensure the Brake release levers are returned to the down / drive position.

5.4.1 Folding The Gas/Powered Reclining Backrest (Standard Seat).

WARNING!

The Lower position of both the Powered Actuator and Manual Gas Strut **MUST** correspond to the Seat depth being used.

Following Seat depth Adjustment you **MUST** ensure the Lower actuator/Gas strut position matches the seat depth set, i.e. use the 17", (430mm) Hole in the lower bracket for a seat depth of 17", (430mm).

After folding the backrest you **MUST** ensure that the lower Actuator/gas strut securing Pin is fitted in the correct location to match the seat depth being used, i.e. use the 17", (430mm) Hole in the lower bracket for a seat depth of 17", (430mm).

Failure to do this will result in potentially unsafe recline angles and the Actuator breaking during operation, the backrest will fall backwards and result in a potential risk for the user to lose postural stability.

1. Pull the retaining pin out, (Fig.5.12).
2. Pull the pivot pin out, (Fig.5.13).
3. Undo the backrest lever bolts, (Fig.5.14).
4. Lay the backrest on the seat, (Fig.5.15)
5. When refitting, please use the correct lower bracket hole, (Fig.5.16). See warning above.

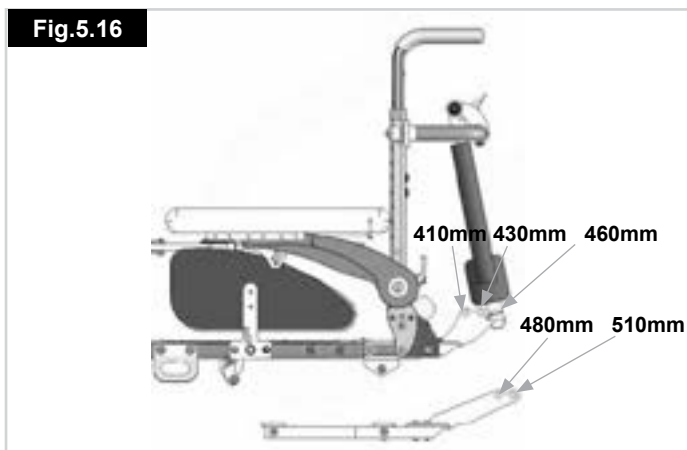
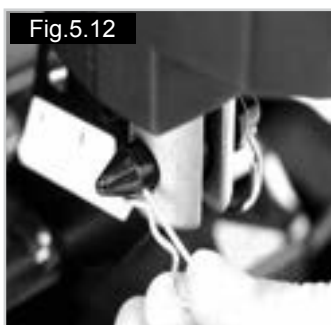

5.5 Drive wheel suspension Salsa

The Salsa R2 has an effective and adjustable drive wheel suspension system as a standard feature. To match your requirements on drive comfort, the tension of the springs at the damper can be adjusted.

Turning the aluminium ring away from the spring will soften your ride, adjusting the aluminium ring in a position towards the spring will harden it. This option is to be used to match the different user weights to the suspension system, (Fig. 5.17). We recommend the suspension adjustments are done equally on the left and right side of the chair.

CAUTION!

The Salsa M2 uses the same suspension units as the Salsa R2, but these must not be adjusted. The Salsa M2 suspension works in a different way and is balanced for optimum performance at the factory, (Fig.5.17.1).

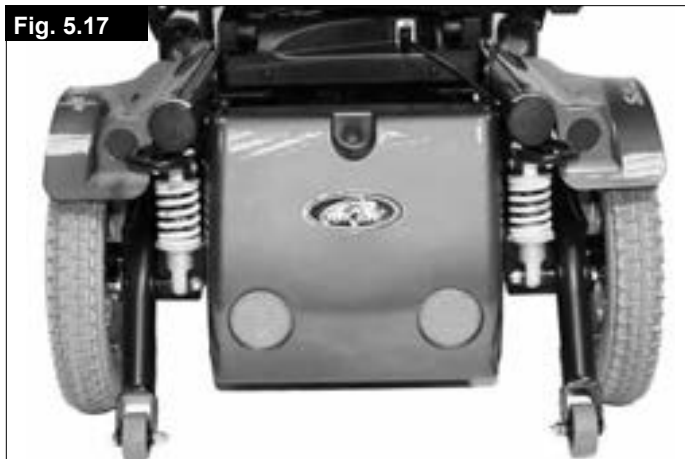

5.6 Control joystick unit position

WARNING!

- Make sure that the control system is mounted securely and that the joystick position is correct.
- The hand or limb you use to operate the joystick should be supported, for example by the arm pad.
- Do not use the joystick as the sole support for your hand or limb - wheelchair movements and bumps could upset your control.

Depending on your chosen control system, there are two principles of control systems: Quickie VR2 and Quickie R-net controls (for details please see the controls section 7 or 8). The remote is mounted on a sliding mechanism which enables the control to be moved forwards and backwards.

- Undo the locking screw, (Fig.5.7).
- Slide the control arm either out or to its new position, (Fig.5.8). See page 22.

When the most comfortable position has been selected, secure the slider by tightening the locking screw. Ensure the locking screw is fully tightened prior to use and especially when transporting your wheelchair.

WARNING!

Ensure the locking screw is fully tightened prior to use, especially when transporting your wheelchair.

5.7 Getting ready to drive

- Operate the on/off switch. The battery gauge will blink then remain on after a second
- Check that the maximum speed is set to a level which suits you.
- Push the joystick to control the speed and direction of the wheelchair

5.8 Standard Armrests

5.8.1 Armrests-removing and replacing (Standard Seat).

The armrests on both sides of the wheelchair can be flipped up to allow side transfer, (Fig. 5.18).

For side transfer flip the armrest all the way up until it goes into its mechanical stop. This frees your space for side transfer.

To bring the armrests back into their position flip it all the way down until it sits on its mechanical stop. Guide it in its downward movement and do not let it fall on its own.

Reclining arm rest:

- Undo the lever at the bottom pivot of the arm rest.
- Lift the arm rest up out the receiver. You can now flip it backwards, (Fig. 5.18.1).

5.8.2 Standard Seat Armrest Height Adjustment

The following section outlines armrest height adjustment. In the case of either fine or gross adjustment, it is a two-part process:

PART 1: Adjust the armrest height through rotation

PART 2: Adjust arm pad angle.

1. Basic fine adjustment.

PART 1 (fig. 5.19 & 5.20)

Up to 25 mm of armrest height adjustment can be achieved using the 5mm fine height adjustment screw to fine tune the armrest's height.

1. Loosen the 6mm rotation bolts on both armrests (B).
2. Turn the adjustment screws (C) counter-clockwise to raise the armrest or clockwise to lower.
3. Retighten both rotation bolts (B).

Use 20 N/m or 177 in/lb of torque.

PART 2 (fig. 5.21 & 5.22)

1. Loosen the 4mm armpad angle pivot bolts (A) on both armrests. Tilt both armpads down (or up in the case of a lowered armrest) until the armpads are in the preferred angle. Check to see if the height is correct.
2. Retighten both armpad angle pivot bolts (A).

Use 10 N/m or 88.5 in/lb of torque for both sets of bolts

WARNING!

Both sets of bolts should be checked periodically for tightness. If loose the armpad could slip down when pressed.

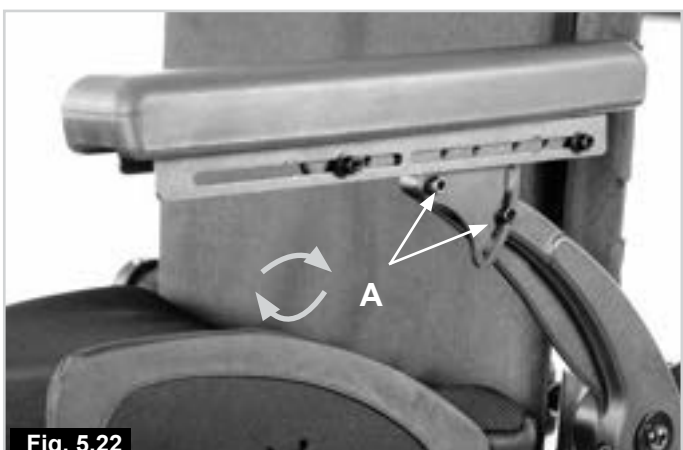
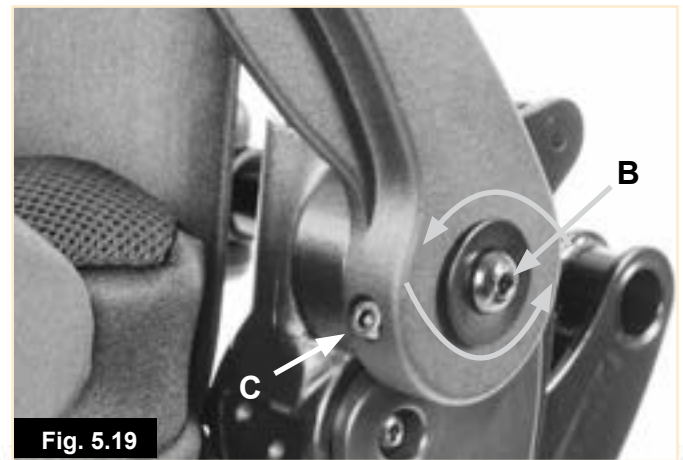
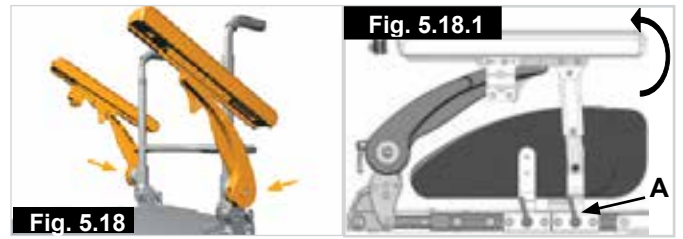

2. Basic coarse adjustment.

PART 1

1. To achieve more than one inch of adjustment, remove the 6mm armrest rotation bolts on both sides of the seat, (Fig.5.23).
2. Remove both armrest assemblies. (Fig.5.24)
3. Remove both sets of 4mm armrest adjustment ring bolts.(Fig.5.25)
4. Rotate the armrest height adjustment rings, (Fig.5.26) to match the desired height designated in the Configuration Chart, (Fig.5.35), on page 25.
5. Replace both sets of armrest adjustment ring bolts according to the configuration chart. (Fig.5.27)
6. Use 10 N/m or 88.5in/lb of torque.
7. Replace both armrest assemblies. (Fig.5.28)
8. Replace the armrest pivot bolts on both sides of the seat, but do not tighten completely. (Fig.5.29)

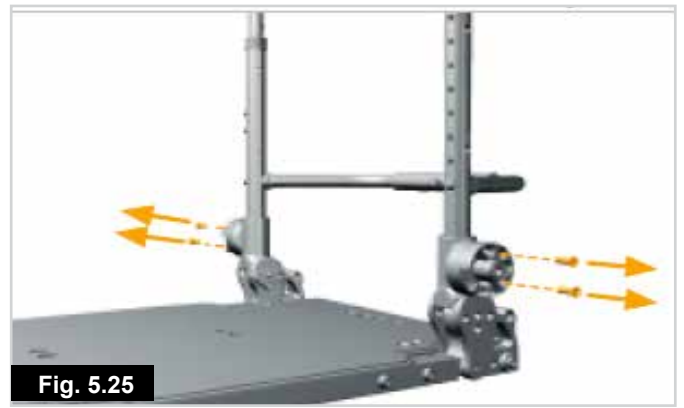

PART 2

1. Loosen the 4mm arm pad angle pivot bolts (A) on both armrests. (Fig.5.30).
2. Loosen the 6mm rotation bolts on both armrests (B). Use the 5mm fine height adjustment screw (C) to finish fine tuning the height. Turn counter-clockwise to increase height or clockwise to lower, (Fig.5.31).
3. Tilt both arm pads down, (or up in the case of a lowered armrest), until the arm pads are in the preferred angle. Check to see if the height is correct, Retighten both armrest pivot bolts, (A). (Fig.5.32).
4. Refer to 2. for fine adjustment.
5. Retighten the 6mm rotation bolts on both armrests, (B). (Fig.5.33).
6. Use 20 N/m or 177 in/lb of torque.
7. Retighten both arm pad angle pivot bolts "A". Use 10 N/m or 88.5 in/lb of torque for both sets of bolts, (Fig.5.34).

WARNING!

Both sets of bolts should be checked periodically for tightness. If loose the armpad could slip down when pressed.

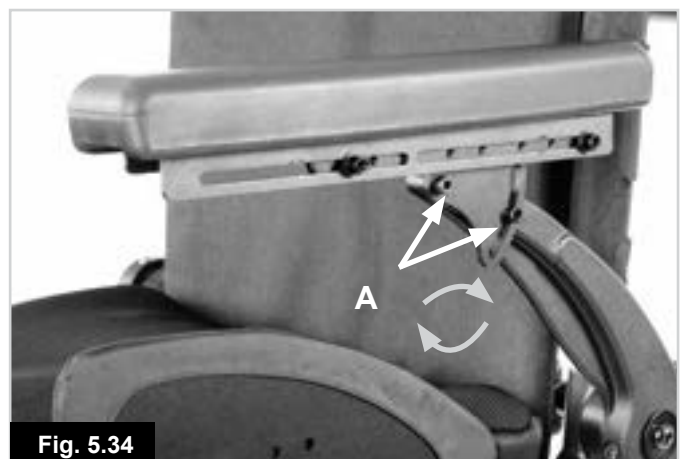
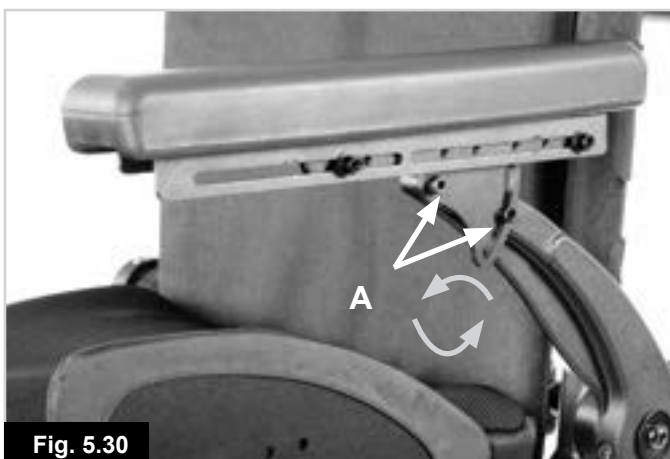
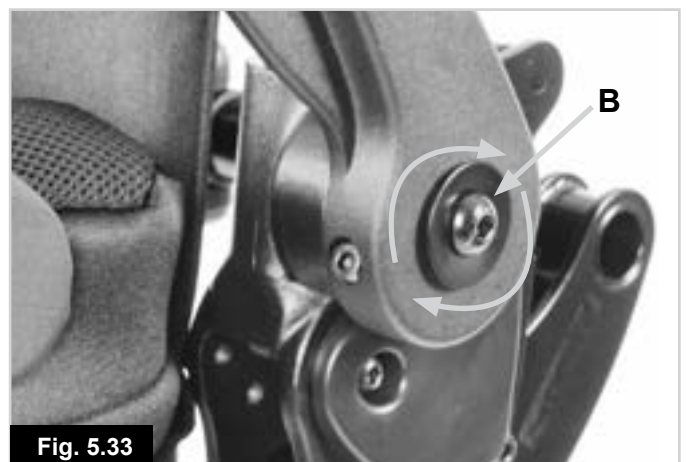
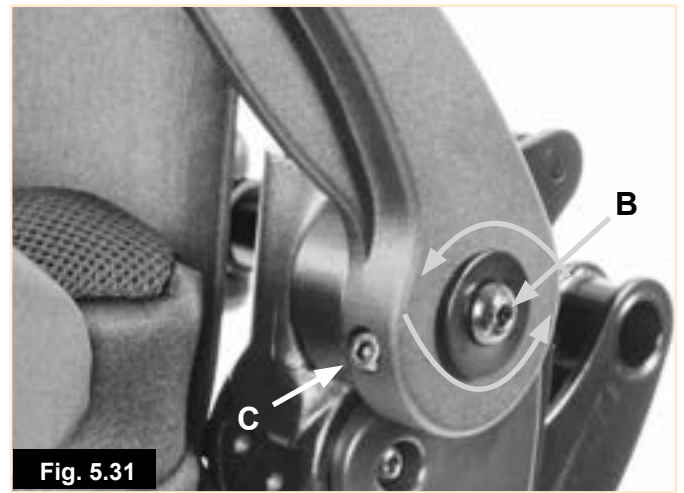

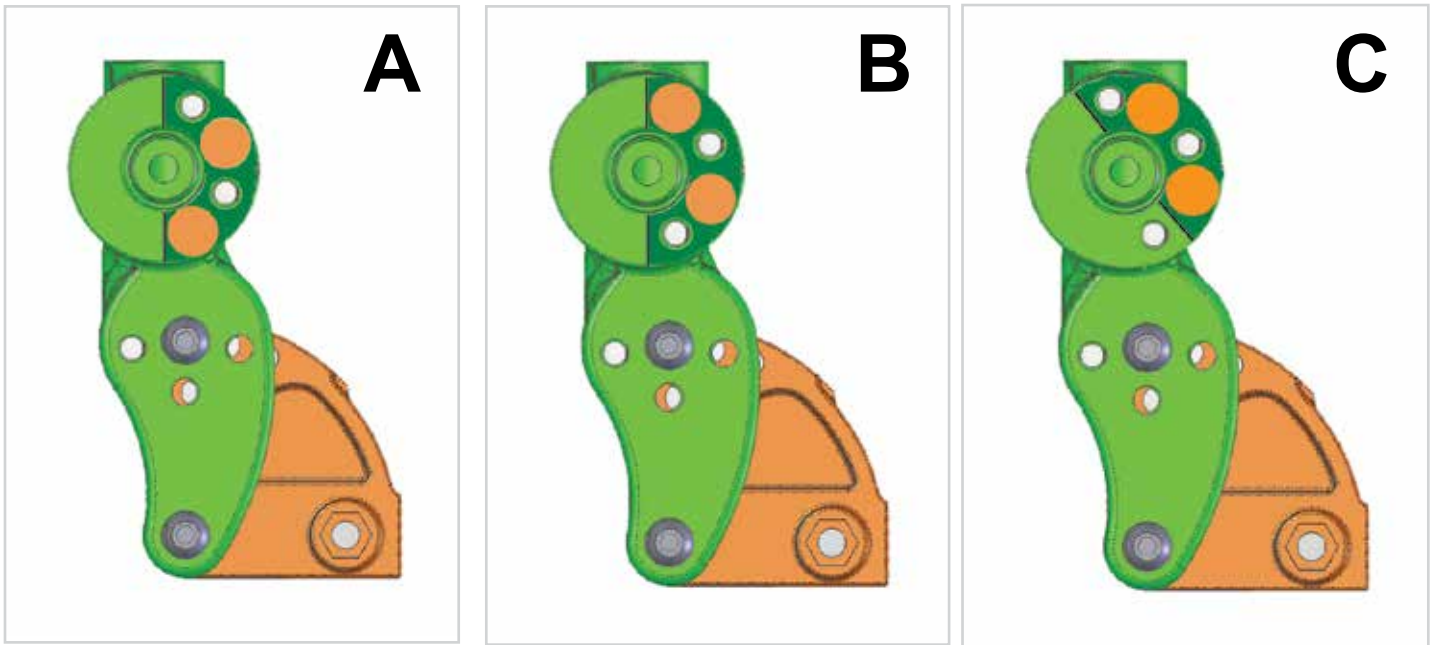

STANDARD CONFIGURATION CHART		
BACKREST ANGLE (Degrees)	ARMREST HEIGHT (mm)	SETTING RING POSITION
-4	305 - 254	A
-4	252 - 229	B
0	305 - 254	A
0	252 - 229	B
4	305 - 267	A
4	279 - 229	B
8	305 - 229	B
12	305 - 229	B
12	248 - 229	C
16	305 - 254	B
16	260 - 229	C

Fig. 5.35

5.8.3 Standard Arm pad Position Adjustment (Fig.5.36-5.39)

1. Fine arm pad position adjustments are possible by loosening the 4mm arm pad adjustment bolts (D). (Fig.5.36)
2. If a Controller mount is fitted loosen the fixing bolts that attaches the control mount to the armrest (E), (Fig.5.37).
3. With the bolts loosened slide the armpad into the desired position. A total of 10cm of adjustment is available via sliding the armpad forward and backwards, (Fig.5.38).
4. Retighten the adjustment bolts, (D). (Fig.5.39).
5. Use 10 N/m or 88.5 in/lb of torque.

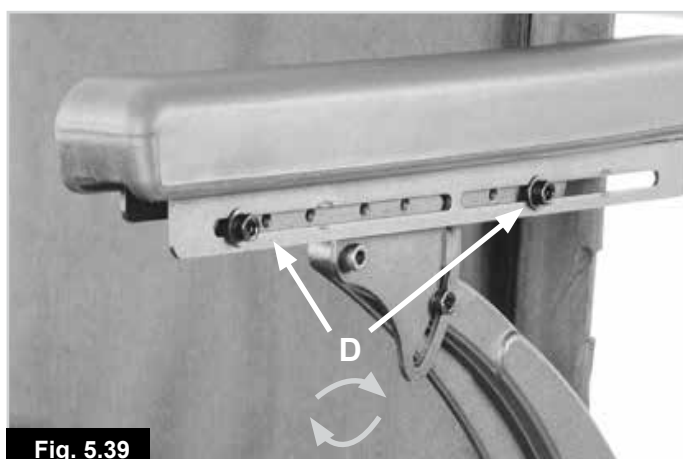
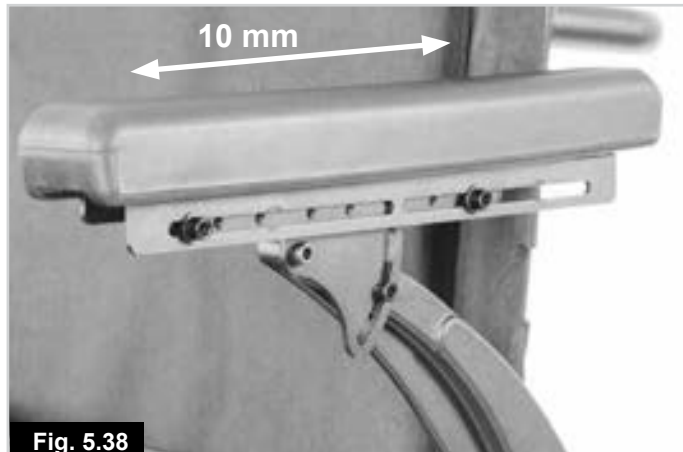
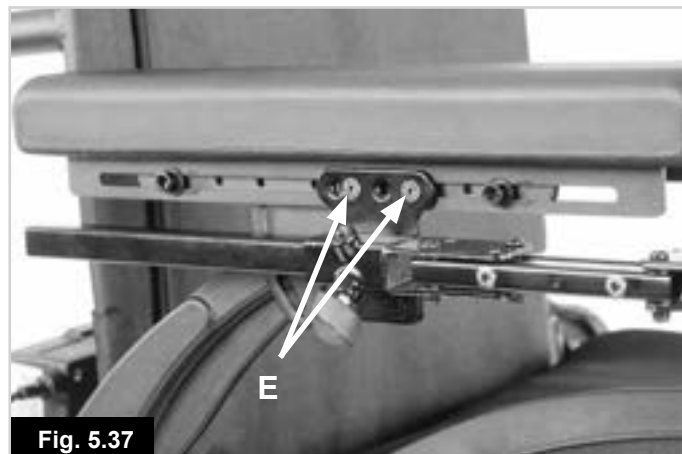
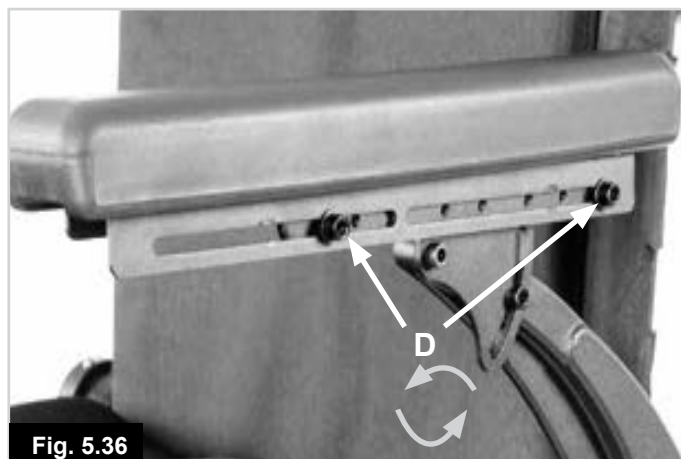

5.8.4 Arm Rests-removing (Rehab Seat)

The arm rests on both sides of the wheelchair can be removed to allow side transfer.

Please refer to your appropriate arm rest type.

For single post arm rests:

- Undo the finger wheel at the bottom of the post,
- Lift the arm rest out of the receiver, (Fig.5.40).

Reclining arm rest:

- Undo the star wheel at the bottom pivot of the arm rest.
- Lift the arm rest up out the receiver. You can now flip it backwards, (Fig. 5.41).

5.8.5 Arm Rests-replacment

Please refer to your appropriate armrest type.

Single Post Armrest Adjustment:

The Single Post armrest can be height adjusted to suit individual user requirements.

1. Remove the fixing bolt located to the outside of the Armrest (A)
2. Lift The Upper Armrest to the desired height and re-fix the fixing bolt, (A). (Fig. 5.40).

Reclining armrest:

Move the arm rest from the flip back position and place the post into the receiver.

Tighten the star wheel on the receiver to lock the post into position, (Fig. 5.41).

5.8.6 Adjusting the armrest width (Jay and Jay Comfort Seat only)

To adjust the width:

- Loosen the four screws (13mm spanner) as shown in (Fig. 5.42).
- Move the armrest receiver brackets to the desired position, (Fig. 5.43).
- Tighten the screws firmly prior to use.

NOTE: Please check that the new arm rest position does not interfere with any seat positioning modules, Lift-Tilt etc.

5.8.7 Adjusting armrest height

Please refer to your appropriate armrest type.

Single Post Arm Rest (Comfort, Rehab and Recaro Seat):

The height adjustment of the armrests is made via the threaded screws at the forward edge of the stanchion tube. To adjust the height, (Fig. 5.40) loosen the adjusting screws (3.0 mm Allen Key), move the armrest to the desired position and tighten the screw.

Reclining arm rest, (Fig.5.41):

- Loosen the screw at the rear armrest receiver.
- Slide the armrest extrusion up or down inside the slot in the backrest frame.
- Tighten the screw at the appropriate height.
- Loosen the set screw on the front post.
- Adjust the front height.
- Tighten all screws.
- Repeat for the other side.

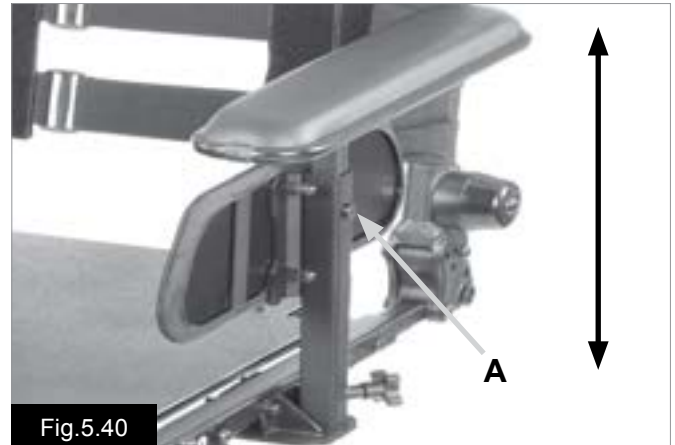

Fig.5.40



Fig.5.41



Fig.5.42



Fig.5.43

5.9 Leg Rests



WARNING!

- Be aware of your environment to make sure you do not injure your legs when Leg Rests are extended.
- Always ensure that the Leg Rests or foot plates do not come into contact with the castors before driving the wheelchair.
- Leg Rests are not to be used for lifting or carrying the wheelchair under any circumstances.
- As with all moving parts be careful not to trap your fingers.

5.9.1 Leg rest removal

To swing away the leg rest:

- Depress the retaining catch and swing the leg rest out, (Fig.5.44).
- Lift the leg rest up and off if removal is required, (Fig.5.45).

To refit:

- Line up the holes and studs, (Fig.5.46).
- Drop the leg rest into the receiver.
- Push the leg rest inwards until it clicks shut, (Fig.5.47).

To adjust the angle: (Fig 5.48-5.49).

- Use a 5.0mm Allen key and 13.0mm spanner to loosen stud A,
- Remove stud B.
- Tilt the receiver until the required hole lines up with the top hole.
- Refit the stud.

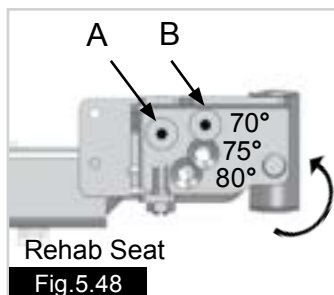

5.9.2 Standard Seat Hanger depth adjustment

- Remove both sets of 5mm hanger depth adjustment bolts, (Fig.5.50).
- Slide both hanger receivers to the desired location, (Fig.5.51, inset B).
- Replace both sets of depth adjustment bolts, (Fig.5.52).
- Use 20 N/m or 177 in/lb of torque.

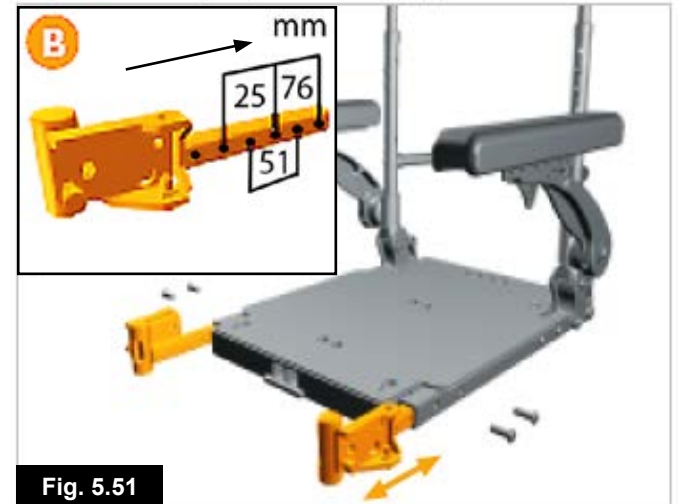

5.9.3 Foot plates

The foot plates may be flipped up to aid entry and exit from the chair.

WARNING!

Do not use the foot plates to stand on as the full weight of your body may cause the chair to tip forwards. This could result in injury and could damage the foot rests.

5.9.4 Adjusting the foot rest length

To adjust the foot rest length remove the bolts/screws on the foot rest stem as shown in (Fig. 5.53, 70° and 5.54), Centre Mount), adjust the length to suit. Ensure the bolts/screws are firmly located and tightened prior to use.

NOTE: The internal foot rest stem may require cutting down in length to allow the foot plate position to be raised.

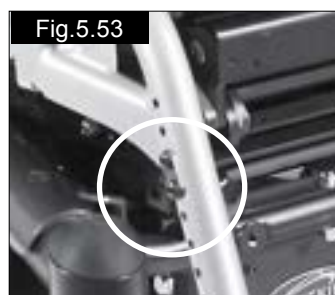

5.9.5 Manual Articulating / Elevating Leg rest

To elevate:

Pull the leg rest upwards and stop at the desired height. The leg rest will automatically lock in the chosen position.

To lower:

Push the release lever slowly forward. The leg rest will lower the angle. As soon as you release the lever, the leg rest will be locked in the current position, (Fig.5.55).



WARNING!

Keep hands clear of the adjustment mechanism between the frame and the movable parts of the leg rest while elevating or lowering the leg rest.

NOTE: Please refer to Section 7 for details of your controls

5.9.6 Powered elevating leg rest, (ELR, Fig.5.56) or articulating leg rest, (ALR, Fig.5.57).

NOTE: Both left and right leg rests can also be operated simultaneously.

To operate a powered ELR, or ALR leg rest:

VR2 Control:

The actuator buttons can operate any factory approved actuator. Operation is dependent on what options are fitted to your wheelchair, (Fig.5.58).

To operate the leg rests, seat tilt, seat lift or backrest recline:

- Push one of the actuator buttons that has the seat icon on it to select actuator mode.
- Operate the joystick left or right to select the actuator required (actuator 1 or actuator 2). Selection is indicated via the lighting of the red LED adjacent to the desired actuator button.
- Operate the joystick in the forward or rearward direction to move the leg rest/seat lift/tilt or recline up or down.
- Release the joystick when the desired angle is reached.
- To return to drive mode press the actuator button again.



CAUTION!

Once the leg rest is fully lifted or in its lowest position do not hold the joystick in its operating position as this could damage the actuator.



R-net Control

Please refer to your R-net Owner's Manual for details.



5.9.7 Powered centre mount leg rest, (PCML).

WARNING!

There is an option on the programme of the leg rest that allows you to send the footrest to the floor to allow for easier mounting and dismounting for the user. Be aware that when powered the area around and underneath the footplate needs to be clear of all personal items and bodily extremities to prevent injury or damage to property.

CAUTION!

Once the leg rest is fully lifted or in its lowest position do not hold the joystick in its operating position as this could damage the actuator.

To Adjust the PCML leg rest Length, (Fig.5.59).

- Use a 5.0mm Allen Key to loosen the 2 studs (A).
- Slide the leg rest to the desired length, (B).
- Tighten the 2 studs, (A).

NOTE : For better access either raise or tilt the seat using the actuator options, or tilt the seat back as per the battery access instructions in Section 10 of this manual.

Quickie Direct Actuator Control Box:

The direct actuator switches can operate any factory approved actuator. Operation is dependent on what options are fitted to your wheelchair. To operate the legrest, seat tilt, seat lift or backrest recline;

- Push the toggle switch for the relevant actuator forward until you reach the required angle/height.
- Release the toggle switch and the actuator will stop.

When the actuator reaches its maximum/minimum position do not hold the toggle switch in its operating position as this could damage the actuator. (Fig. 5.60)



R-net Control

Please refer to your R-net Owner's Manual for details.

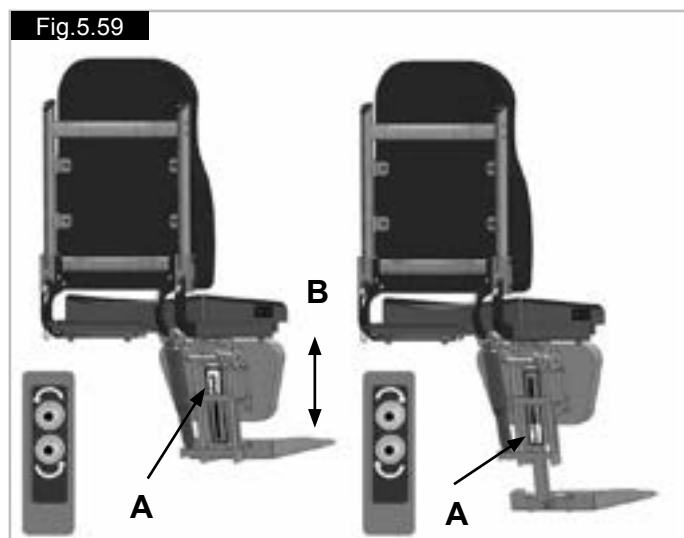

6.0 Seating

6.1 Firm seat board

The firm seat board is designed to allow pressure relief cushions such as Jay to be used, (Fig.6.1).

6.2 Seat cushions

Seat cushions supplied by Sunrise Medical will have Velcro® strips that correspond to patches on the seat, (Fig.6.2).

WARNING!

You must ensure these are aligned prior to using the wheelchair. Other cushions used should also have Velcro® strips in a similar position to ensure the cushion does not slip off the seat.

NOTE: The seat cushions, supplied by Sunrise Medical all have removable covers.

6.3 Removable seat covers

The seat covers are all fully removable using zips or Velcro®. Once brackets are removed seat covers can be removed. The zip for the backrest is located on the underside of the cushion.

6.4 Backrest upholstery

Salsa is supplied with optima backrest upholstery, which can be adjusted in tension to the individual's requirements.

Tension adjustable back:

To change the shape and/or tension of the 'Optima' backrest, remove the padded cover from the rear of the backrest and expose the tension straps. Loosen or tighten the straps to suit. (The most comfortable and supportive position is achieved with the wheelchair user seated in the chair). Ensure the straps are securely fastened and replace the padded cover prior to use, (Fig.6.3).

6.5 JAY backrests

The rehab backrest assembly will allow the fitting of a JAY backrest, which is available as an optional extra.

6.6 Manual angle adjustment of the Rehab fixed back

To adjust the back angle:

- Use a 13.0mm spanner.
- Remove the two screws on the mechanical fixed recline adjusters, (Fig.6.4).
- After removing the screws you can set the back angle between -3°(degrees) and 12°.
- Refit and tighten all screws to the correct torque.

WARNING!

You must ensure all 4 screws are securely tightened and the backrest is correctly and firmly in position prior to using your chair.

6.7 Standard Seat width adjustment

1. Remove the 5mm width adjustment bolts (A) and the 4mm towel bar adjustment bolt (B), (Fig.6.5) .
2. Move the left side seat rail, armrest and backrest assembly to the desired position. See seat width position settings (C), (Fig.6.6). Refit bolts and tighten to 10Nm, (A-B)

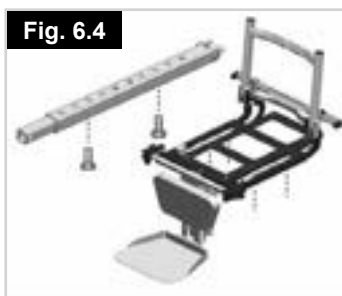

6.8 Rehab seat depth

- Loosen or remove the arm rest width adjustment screws, using a 13.0 mm spanner, (1 and 2, Fig 6.7).
- Loosen the Mechanical Fixed Recline/ Gas Strut / electric Actuator fixing screws, using a 13.0 mm spanner, (3, Fig 6.8).
- Repeat for the other side.
- Slide the inner seat frame to the desired position.
- Refit/tighten all screws and brackets.

NOTE: The Banana brackets that determine the fixed seat tilt angle may also have to be moved, (Section 6.14).

WARNING!

- Sunrise Medical strongly recommend that you contact your approved Sunrise medical servicing agent to carry out this task.

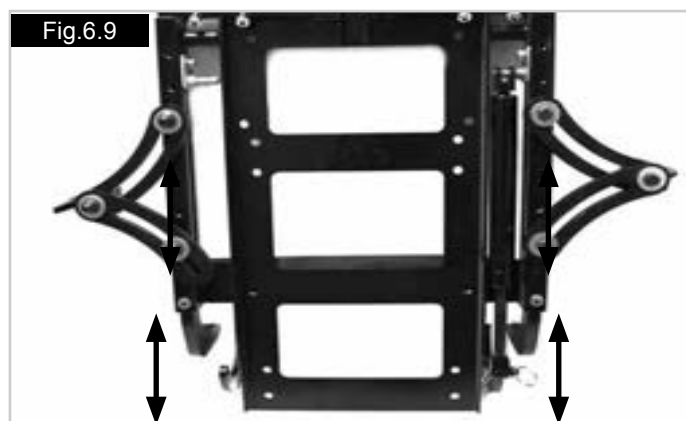
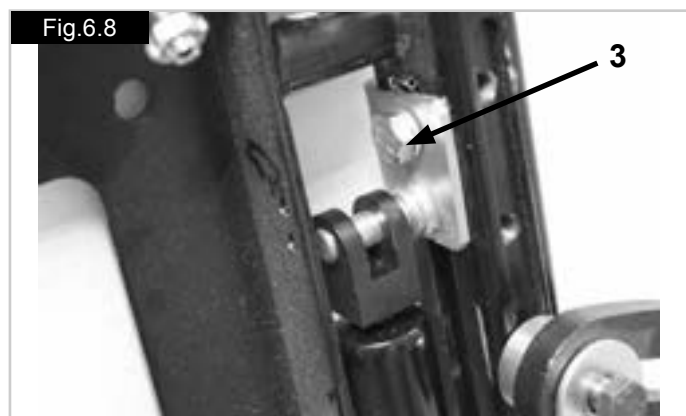
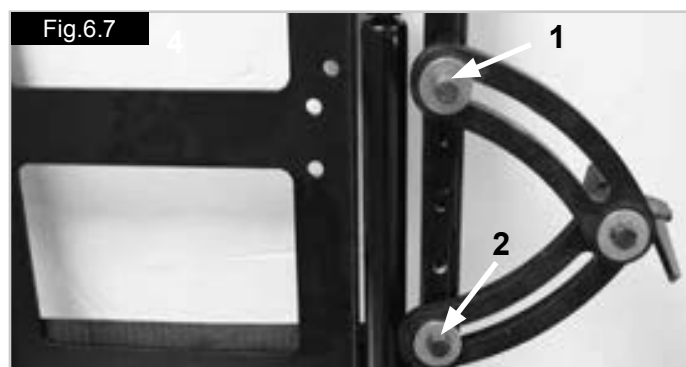

6.9 Standard Seat height adjustment

WARNING!

Make sure the top frame does not trap your fingers. Get someone to hold the seat steady during adjustment.

To change the seat height:

Salsa R2 Rear Wheel Drive with Module Interface only:

- Remove the two bolts from the front seat interface fixation, using a 5mm allen key.
- Remove the bolts from the rear of the seat interface.
- Fit the seat height extension kit to the rear of the interface and connect it to the frame.
- Connect the front part of the connector kit to the lower holes.
- Ensure all fixings are tightened to the correct torque.

Salsa M2 Mid-Wheel Drive only:

- Release the two handle screws under the front of the seat frame that connect the seat frame with the seat module interface.
- Flip the seat frame backwards and secure it with the safety bar, (like the bonnet of a car).

CAUTION!

- Depending on options, the seat may be heavy to lift. It is recommended that two people carry out this action.
- Avoid pivoting the seat more than 60° rearwards.
- Remove the 2 socket studs from the back seat posts.
- Lift/lower the seat to the required position.
- Align the holes then refit & tighten the socket studs.
- Remove the 2 socket studs from the front seat posts.
- Lift/lower the posts to match the required position.
- Align the holes then refit & tighten the socket studs.
- Close the seat, refit & tighten the hand wheels (fig.6.10).

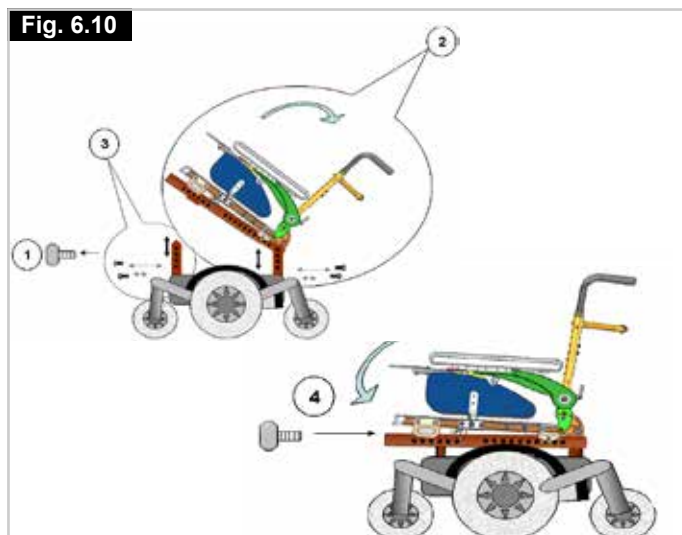

6.10 Standard Seat Depth Adjustment

1. Remove the 5mm depth adjustment bolts from both sides of the seat, (Fig.6.11).



2. Slide the rear backrest and armrests into the desired seat depth position. Reference seat depth position patterns (A), (Fig.6.12).

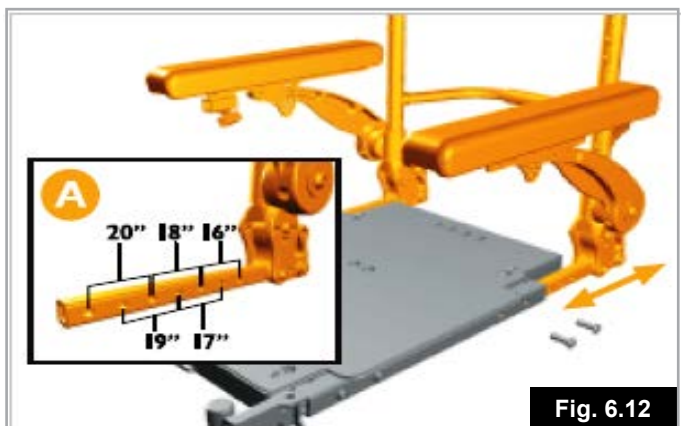

3. Replace both sets of depth adjustment bolts. Use 20 N/m or 177 in/lb of torque, (Fig.6.13).



6.11 Backrest Angle Adjustment

1. Remove the 5mm backrest bracket index bolts (A) on both sides of the backrest. Loosen the 5mm backrest bracket pivot bolts (B) on both sides of the backrest.

NOTE: The index bolt (A) may be in a different starting position than shown below in Fig.6.14.

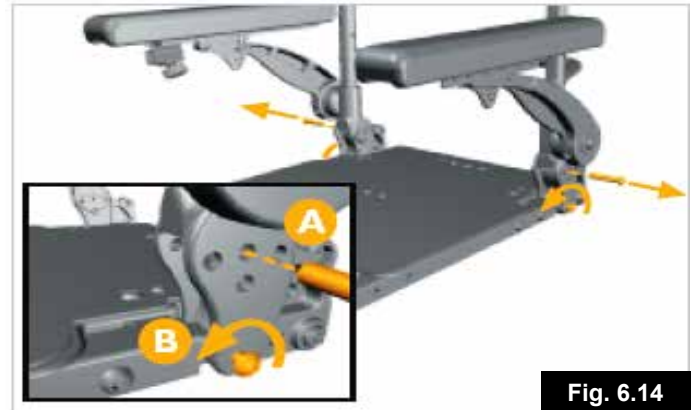

2. Tilt the backrest assembly forward or backward to the desired angle. See angle configurations below, (Fig.6.15 next page).

Fig. 6.15



3. Reinsert and tighten both backrest bracket index bolts and bracket bolts (A & B). Use 20 N/m or 177 in/lb of torque, (Fig.6.16).

NOTE: The figures below represent the 8°angle.

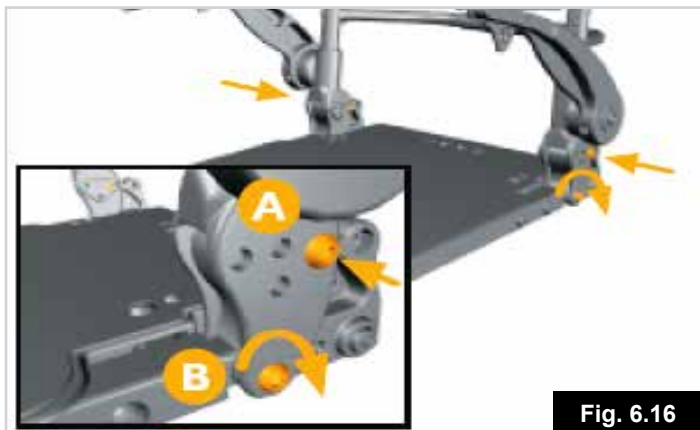

6.12 Back Height Adjustment

1. Begin by removing the upholstery cover, (Fig.6.17).

Fig. 6.17



2. Loosen the upholstery straps. It is not necessary to remove the upholstery, (Fig.6.18).

Fig. 6.18



3. Remove the top upholstery screws. The upholstery can now be moved and vertically compressed to provide access to the hidden Phillips-head bolts, (Fig.6.19).

Fig. 6.19



4. Remove the 4mm towel bar bolts and the towel bar, (Fig.6.20).

NOTE: This step is not necessary in every case. If the push handles are high enough, the towel bar bolts might not thread into the push handle tubes. To test, skip this step and move to Numbers 5 and 6. If the towel bar does not impede movement of the push handles, the towel bar may be left intact.



5. Remove the 4mm back post adjustment bolts, (Fig.6.21).



6. Move both back posts to the desired height, (Fig.6.22).



7. Replace the backpost adjustment screws. Use 10 N/m or 88.5 in/lb of torque, (Fig.6.23).



8. If removed in Number 4, replace the towel bar and the towel bar bolts. Use 10 N/m or 88.5 in/lb of torque, (Fig.6.24).

NOTE: The towel bar may be repositioned at this point as well.



9. Replace both top upholstery bolts. Ensure the bolts thread through the top upholstery eyelets (A), (Fig.6.25).



10. Retighten the upholstery straps, (Fig.6.26).



11. Reattach the upholstery cover, (Fig.6.27).



6.13 Manual adjustable backrest (Standard seat)

For depth adjustment see section 6.8.

To recline the backrest angle:

- Pull the lever at the top of the backrest which operates the gas strut.
- Hold the lever and adjust the back angle required.
- If you release the lever, the angle will stay in the adjusted position.
- If you want to adjust the backrest into the upright position, you might need to support the upward motion (Fig.6.28).



6.14 Manual setting of the seat angle on the SALSA

To set the seat angle, release the bolt fixing the “Banana” bracket between the seat interface module and the seat packer module. Set the seat angle at 0°, 3° or 6° and 9°, then replace and retighten the bolt between the seat interface module and the seat packer module. (Fig.6.29).

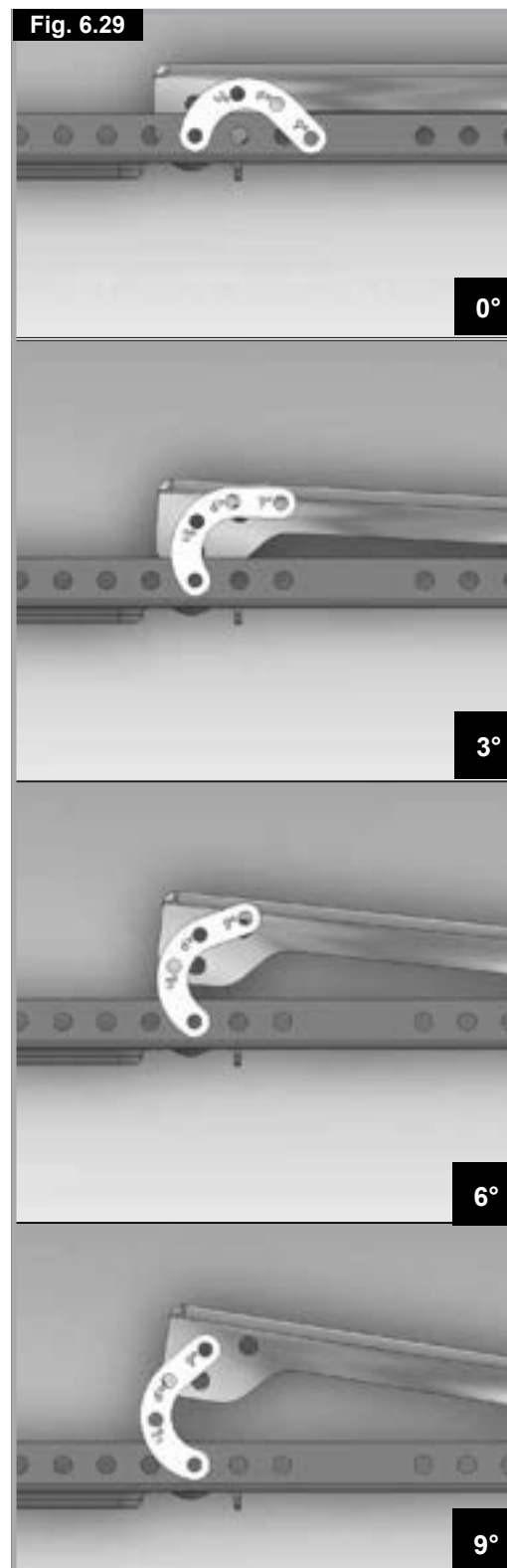

6.15 Manual adjustable backrest (manual recline Rehab Seat)

For depth adjustment see section 6.2.

To recline the backrest angle, pull the lever at the top of the backrest which operates the gas strut. Hold the lever and adjust the back angle required. If you release the lever, the angle will stay in the adjusted position. If you want to adjust the backrest into the upright position, you might need to support the upward motion (Fig. 6.29.1).



6.16 JAY backrests

The standard backrest assembly will allow the fitting of a JAY backrest, which is available as an optional extra.

6.17 Headrest

To fit the Standard headrest, fit the location bracket to the push handles, using the screws and nuts supplied, ensuring that they are fully tightened.

To fit the Rehab headrest, fit the location bracket to the backrest bracket, using the screws and nuts supplied, ensuring that they are fully tightened.

Adjusting the Headrest (All).

The headrest height is changed by loosening the adjustment knob and sliding the inner vertical tube to the desired position and tightening the knob. The headrest to seat depth is adjusted by loosening the 6mm Allen screws and moving the hinge to the desired position and then tightening the screws securely. To adjust the headrest angle, loosen the screws at the headrest upholstery, position the headrest as required and tighten the screws securely. (Fig.6.30)



6.18 Powered Seating

Powered adjustable backrest.

Powered seat Lift.



Powered Seat Tilt

WARNINGS!

- Lowering the backrest by an angle of greater than 15° from vertical alters the balance of your wheelchair. Never exceed 15° of recline when on any gradient or when driving your wheelchair.
- Operating the powered tilt greater than 9° from its lowest position will bring the chair into "creep mode". If this operation occurs simultaneously with the seat lifted the chair will be inhibited and will not drive.

Elevating the powered lift from its lowest position will bring the chair into "creep mode". Resetting the powered lift to its lowest position will allow full speed. **VR2 CONTROL** (Fig.6.31)

WARNING!

It is possible to reverse the direction of an actuator relative to the direction of the joystick. Ensure you know which direction to move the joystick for the desired operation. Failure to do so may result in damage and/or injury.

NOTE: Please refer to Section 7 or 8 for details of your hand control.

NOTE: If fitted, all of the above power seating options are controlled via the VR2 Control, in the same way. Please see the section, "To operate the Actuators", below.

NOTE: The seat can lift up to 30 cm by operating it through your control system.

To operate the Backrest Actuators:

- Push the mode button to select actuator mode
- Operate the joystick left or right to select the actuator required (actuator 1 or actuator 2). Selection is indicated via the lighting of the orange LED adjacent to the desired actuator number.
- Operate the joystick in the forward or rearward direction to move the backrest up or down.
- Release the joystick when the desired angle is reached.
- To return to drive mode, press the actuator button again.

CAUTION!

Once the back is fully reclined/forward, or the lift is fully raised/lowered, or the seat is fully tilted backwards/forwards, do not continue to hold the joystick in its operating position as this could damage the actuator.



R-net Control

Please refer to your R-net Owner's Manual for details.

Fig. 6.31



6.18.2 Powered seat lift

The seat can lift up to 30 cm by operating it through your control system.

WARNING!

- Before operating the seat lift function ensure that the immediate area around the wheelchair is clear of possible obstructions,
- (eg wall shelving), and potential hazards, (eg small children and pets).
- Operating the seat lift will limit the drive speed of the wheelchair.
- Operating the seat lift and another electric option will stop the drive all together.

VR2 Control:

To operate the powered lift:

- Push one of the actuator buttons that has the seat icon on it to select actuator mode.
- Operate the joystick left or right to select the actuator required (actuator 1 or actuator 2). Selection is indicated via the lighting of the red LED adjacent to the desired actuator button.
- Operate the joystick in the forward or rearward direction to move the seat lift up or down.
- Release the joystick when the desired height is reached.
- To return to drive mode press the actuator button again.

CAUTION!

Once the seat is fully raised or fully down, do not hold the joystick in its operating position as this could damage the actuator



R-net Control

Please refer to your R-net Owner's Manual for details.

6.18.3 Powered seat tilt

The seat can be tilted by operating your control system.

VR2 Control:

To operate the powered tilt please follow the instructions listed in section 6.11.2, but select the actuator button associated with the Tilt function.

WARNING!

- Before operating the seat Tilt function ensure that the immediate area around the wheelchair is clear of possible obstructions, (Fig. 6.32).
- (eg wall shelving), and potential hazards, (eg small children and pets).
- Operating the seat Tilt will limit the drive speed of the wheelchair.
- Operating the seat Tilt and another electric option will stop the drive all together.



R-net Control

Please refer to your R-net Owner's Manual for details.

NOTE: With the seat lift raised the maximum speed is limited to approximately 10% of its normal value. This is known as "Creep Mode".

Raising the seat in combination with other powered seating options, such as tilt/recline/leg rests, can suspend the normal drive options, (depending on programming). This is quite normal and is a safety feature.

To start driving the wheelchair again, bring the seating options back to their start positions.

Fig.6.32

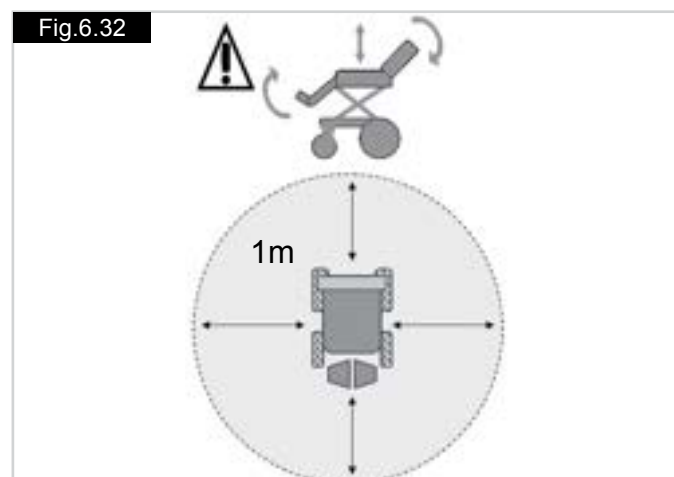

6.18.4 Quickie Direct Actuator Control Box (Fig.6.33)

To operate the backrest, seat lift, seat tilt:

- Push the relevant toggle switch into the forward position.
- Release the toggle switch when the desired backrest angle, seat lift height or seat tilt angle is reached.

CAUTION!

Once the back is fully reclined/forward, or the lift is fully raised/lowered, or the seat is fully tilted backwards/forwards, do not continue to hold the switch in its operating position as this could damage the actuator.



7.0 Control System

7.0 R-net control system information

An alternative control system called R-net is available as an option for the wheelchair.

The R-net system has extended options and is suitable for individuals with complex needs or when there is a preference for screen based menu options and information displays.

The R-net control system offers simple, effective solutions to many situations, thereby enhancing the lifestyle and independence of the user.

The operation of the R-net wheelchair control system is simple and easy to understand. Both the R-net and VR2 control systems incorporate state-of-the-art electronics, the result of many years of research, to provide you with ease of use and a very high level of safety.

Because of the comprehensive nature of the R-net control system, a separate R-net Owner's Manual is supplied whenever this system is fitted.



Please refer to the R-net Owner's Manual for details of R-net hand control functions.

7.1 VR2 control system information

On/off button:

The on/off button applies power to the control system electronics, which in turn supply power to the wheelchairs motors.

CAUTION!

Do not use the on/off button to stop the wheelchair unless there is an emergency. (If you do you may shorten the life of the wheelchair drive components)

Battery gauge:

The battery gauge shows you that the wheelchair is switched on. It also indicates the status of the wheelchair. Refer to chapter 8.

Locking/unlocking the wheelchair:

The VR2 control system can be locked to prevent unauthorised use. The locking method is via a sequence of key presses and joystick movements as detailed below.

To lock the wheelchair:

- While the control system is switched on, depress and hold the on/off button
- After 1 second the control system will beep. Now release the on/off button
- Deflect the joystick forwards until the control system beeps
- Deflect the joystick in reverse until the control system beeps
- Release the joystick, there will be a long beep
- The wheelchair is now locked

To unlock the wheelchair:

- Use the on/off button to switch the control system on. The maximum speed/profile indicator will be rippling up and down
- Deflect the joystick forwards until the control system beeps
- Deflect the joystick in reverse until the control system beeps
- Release the joystick, there will be a long beep
- The wheelchair is now unlocked

Operating the control joystick:

When engaging the main On/Off button, allow a few seconds prior to moving the joystick. This allows the system to self check. If you move the joystick too soon, the battery level indicator display will not illuminate until the joystick is released.

If it is off null for more than 5 seconds a system error will occur. Whilst this is not harmful to your wheelchair, you will need to switch off and then back on to clear the system.

NOTE: This is a safety feature to prevent unintended movement.

Proportional control summary

1. To steer, move the joystick in the direction you wish to go.
2. The further you move the joystick, the faster you will go.
3. The brakes will automatically stop the wheelchair from any speed when the joystick is released.

 **WARNING!**

New users should use slower speeds until they feel confident when driving the wheelchair.

 **WARNING!**

It is important that the chair is stationary when changing direction from reverse to forward.

 **WARNING!**

Always switch off before getting into or out of the chair.

Maximum speed/profile indicator:

This is a gauge which shows the maximum speed setting for the wheelchair or if the control system is programmed for drive profile operation, the selected drive profile. This gauge also indicates if the speed of the wheelchair is being limited or if the control system is locked.

The horn button:

The horn will sound while this button is depressed.

Speed / Profile decrease button:

This button decreases the maximum speed setting or, if the control system is programmed for drive profile operation, selects a lower drive profile.

Speed / Profile increase button:

This button increases the maximum speed setting or, if the control system is programmed for drive profile operation, selects a higher drive profile.

Actuator button and LEDs:

Depending on whether your wheelchair is fitted with one or two actuators the operation of these buttons will differ.

Wheelchairs with one actuator

Depressing either actuator button will enter actuator adjustment mode. This will be indicated by the illumination of both actuator LED's. Actuator adjustment can then be made by deflecting the joystick forwards or backwards. To re enter drive mode, depress either actuator button

Wheelchairs with two actuators

Depressing either actuator button will enter actuator adjustment mode.

If the left button is depressed the associated LED will be illuminated, and deflection of the joystick will adjust the actuator motor connected to that channel.

If the right button is depressed the associated LED will be illuminated, and deflection of the joystick will adjust the actuator motor connected to the other channel.

To re enter drive mode, depress the selected actuator button, as indicated by the associated LED

It is also possible to select the other actuator by left or right movements of the joystick

**R-net Control**

Please refer to your R-net Owner's Manual for details.

Charging and programming socket: **WARNING!**

This socket should only be used for programming and charging the wheelchair.

 **WARNING!**

This socket should not be used as a power supply for any other device. Connection of other electrical devices may damage the control system or affect the EMC performance of the wheelchair
See section 11 about charging.

The programming socket will enable an approved Sunrise Medical authorised dealer to re-programme your chair and also gain useful information when tracing any faults. When the chair leaves the factory, the parameters of the controller are set to default.

To programme the controller you need a special programming device (handheld or PC software), which is available through your Sunrise Medical authorised dealer.

 **WARNING!**

Programming the controller of the wheelchair is only allowed through authorised personnel trained by Sunrise Medical. Incorrect controller settings could cause driving outside the safe limits and could result in damage or injury.

 **WARNING!**

SUNRISE MEDICAL does not accept responsibility for damages which result from unexpected stopping of the wheelchair or inappropriate programming or unauthorised use of the wheelchair.

**R-net Control**

Please refer to your R-net Owner's Manual for details.

7.2 VR2-L

There are common controls between the VR2 and the VR2-L control systems where a control differs it will be described below. All common controls can be found on the previous page.

Lights and indicators:

The SALSAR can be equipped with lights and indicators. Where lights are not factory fitted, they may be fitted as an optional extra by an approved Sunrise Medical authorised dealer.

WARNING!

Ensure that the lights and indicators are functioning correctly and lenses are clean before going outdoors at night.

Indicators:

To turn on the wheelchairs indicators operate the required button either left or right, the associated LED will also illuminate continuously.

Depress the indicator button to turn off the indicator and the associated LED

CAUTION!

If the LED flashes rapidly either a total short circuit, a single lamp open circuit or a total open circuit in the left or right indicator circuit has been detected

Main lights:

To turn on the wheelchairs lights operate this button, the associated LED will illuminate continuously.

Depress the light button to turn off the lights and the associated LED

CAUTION!

If the LED flashes a short circuit in the lighting circuit has been detected.

Hazard warning lights:

To turn on the wheelchairs hazard warning lights operate this button, the associated LED will flash at the same rate. The left and right turn indicator LEDs will also flash. Depress the hazard warning button to turn off the lights and the associated LED.

CAUTION!

If the LED flashes rapidly either a total short circuit, a single lamp open circuit or a total open circuit in the entire indicator circuit has been detected

Actuator button and LEDs:

Depending on whether your wheelchair is fitted with one or two actuators the operation of this button will differ.

Wheelchairs with one actuator

Depressing the actuator button will enter actuator adjustment mode. This will be indicated by the illumination of both actuator LED's. Actuator adjustment can then be made by deflecting the joystick forwards or backwards. To re enter drive mode, depress either actuator button

Wheelchairs with two actuators

Depressing the actuator button will enter actuator adjustment mode. Depressing the button once illuminates the left LED, and deflection of the joystick will adjust the actuator motor connected to that channel. If the right button is depressed the associated LED will be illuminated, and deflection of the joystick will adjust the actuator motor connected to the other channel.

To re enter drive mode, depress the selected actuator button, as indicated by the associated LED

It is also possible to select the other actuator by left or right movements of the joystick



R-net Control

Please refer to your R-net Owner's Manual for details.

7.3 VR2 Dual control unit

Control button and indicator:

This shows which joystick has control. If the red wheelchair light is on the wheelchair occupants joystick has control. If the green attendant light is on the dual attendant systems joystick has control. The button is used to transfer control between the two choices

Actuator button and LED:

All VR2 dual attendant systems have an actuator button fitted as standard.

NOTE: If the VR2 is programmed with no actuators then this button has no function.

Wheelchairs with one actuator:

Depressing the actuator button once will enter actuator adjustment mode. This will be indicated by the illumination of both actuator LED's. Actuator adjustment can then be made by deflecting the joystick forwards and backwards. To re enter drive mode, depress either the actuator button or the speed button

Wheelchairs with two actuators:

Depressing the actuator button will enter actuator adjustment mode. Depressing the button once illuminates the left LED and deflection of the joystick forwards or backwards will adjust the actuator connected to that channel. Selection between the two actuators is achieved by deflecting the joystick to the left and right. As the actuator selected changes so will the LED which illuminates. Left for actuator 1 and right for actuator 2. To re enter drive mode, depress either the actuator button or the speed button

Maximum speed button and indicator:

This shows the maximum speed setting for the wheelchair when the dual attendant system has control. There are five settings - setting 1 is the slowest speed and setting 5 is the highest speed. The speed setting is changed with the speed button.

NOTE: If the control system is programmed for drive profile operation, then the dual attendant system speed adjuster will only adjust the speed within the selected profile.

NOTE: Changing between drive profiles can only be achieved using the VR2



R-net Control

Please refer to your R-net Owner's Manual for details.

Fig.7.1

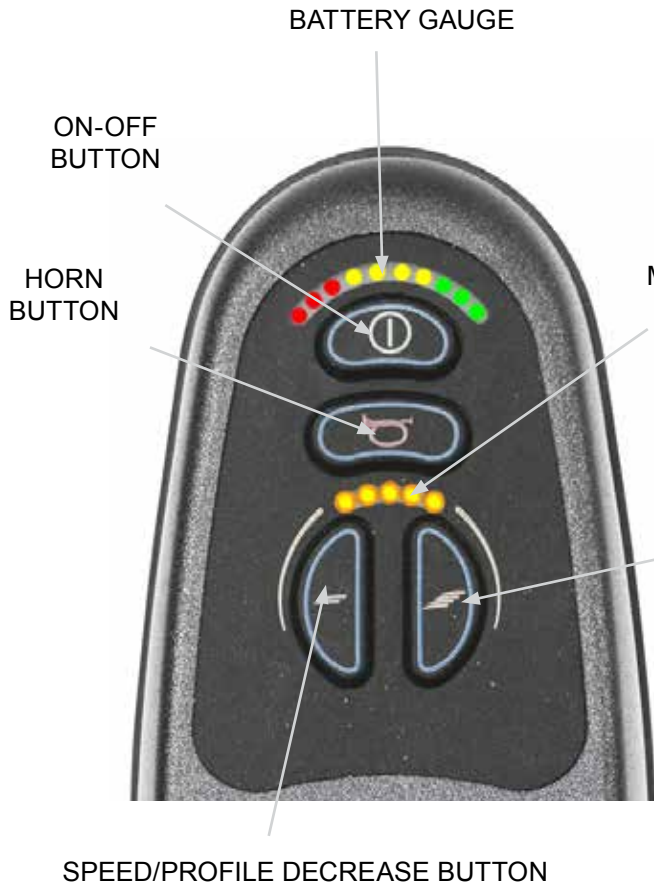

VR2 CONTROL PANEL LAYOUT

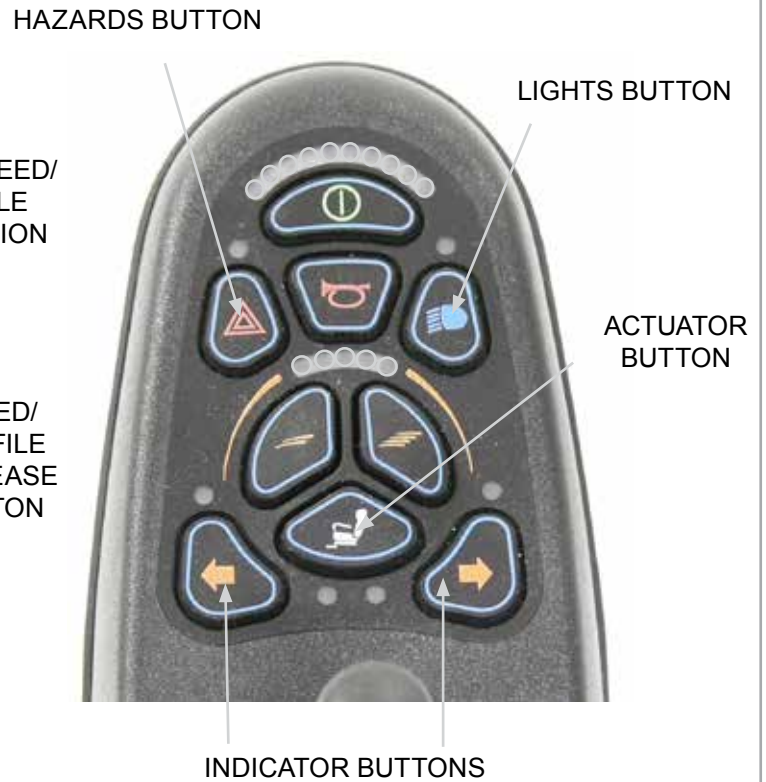

VR2-L CONTROL PANEL LAYOUT



VR2 DUAL CONTROL UNIT



8.0 Troubleshooting using the VR2 Hand Control



WARNING!

Always consult your Sunrise Medical authorised dealer when a diagnostic fault has appeared on your hand control.

The battery gauge and maximum speed/profile indicator show the status of the control system.

Battery Gauge is steady:

This indicates that everything is OK.

Battery Gauge flashes slowly:

The control system is functioning correctly but the batteries need charging as soon as possible.

NOTE: At battery voltages below 16,5V the controller will switch off to protect the batteries from deep discharge damage. In this case (last red battery indicator LED flashing), charge the batteries immediately.

Battery Gauge steps up:

The wheelchair batteries are being charged. You will not be able to drive the wheelchair until the charger is disconnected and you have switched the control system off and on again.

Battery Gauge flashes rapidly even with the joystick released:

The control system safety circuits have operated and the control system has been prevented from moving the wheelchair.

This indicates a system trip. i.e. the VR2 has detected a problem somewhere in the wheelchairs electrical system.

- Switch off the control system
- Make sure that all connectors on the wheelchair and the control system are mated securely.
- Check the condition of the battery
- If you can't find the problem, try the self help guide given over the page, (Fig.8.1)
- Switch on the control system again and try to drive the wheelchair.



WARNING!

If the safety circuits operate again, switch off and do not try to use the wheelchair.

Contact your Sunrise Medical Authorised Dealer.

Self help guide: (Fig.8.1, overleaf).

If a system trip occurs you can find out what has happened by counting the number of bars on the battery gauge that are flashing.

Go to the number on the list which matches the number of flashing bars and follow the instructions.

Slow or sluggish movement:

If the wheelchair does not travel at full speed or does not respond quickly enough and the battery condition is good, check the maximum speed setting. If adjusting the speed setting does not remedy the problem then there may be a non hazardous fault.

Consult your Sunrise Medical Authorised Dealer.

Speed / Profile Indicator ripples up and down:

This indicates the control system is locked, refer to section 7.1. for details on how to unlock the control system.

Speed / Profile Indicator flashes:

This indicates that the speed of the wheelchair is being limited for safety reasons. The exact cause will depend on the build of the chair but usually indicates that the seat is elevated.

Actuator LED flashes:

This indicates that the actuators may be inhibited in one or both directions.

Consult your Sunrise Medical Authorised Dealer.



R-net Control

Please refer to your R-net Owner's Manual for details.

Fig.8.1

Fault code	Possible cause		
	The batteries need charging, or there is a bad connection to the battery. Check the connections to the battery. If the connections are good, try charging the batteries		
	The left hand motor has a bad connection. Check the connections to the left hand motor.		
	The left hand motor has a short circuit to a battery connection. Contact your Sunrise Medical Authorised Dealer		
	The right hand motor has a bad connection. Check the connections to the right hand motor.		
	The right hand motor has a short circuit to a battery connection. Contact your Sunrise Medical Authorised Dealer		
	The wheelchair is being prevented from driving by an external signal. One possibility is that the battery charger is plugged in.		
	A joystick fault is indicated. Make sure that the joystick is in the centre position before switching on the control system		
	A control system fault is indicated. Make sure the control system connections are secure.		
	The parking brakes have a bad connection. Check the parking brake and the motor connections. Make sure that the control system connections are secure		
	An excessive voltage has been applied to the control system. This is usually caused by a poor battery connection. Check the battery connections		
	<table border="0"> <tr> <td data-bbox="304 1290 379 1395">+ S</td> <td data-bbox="379 1290 1511 1395">S=Speed indicator LED's A communication fault is indicated. Make sure that the joystick cable is securely connected and not damaged</td> </tr> </table>	+ S	S=Speed indicator LED's A communication fault is indicated. Make sure that the joystick cable is securely connected and not damaged
+ S	S=Speed indicator LED's A communication fault is indicated. Make sure that the joystick cable is securely connected and not damaged		
	<table border="0"> <tr> <td data-bbox="304 1395 379 1500">+ A</td> <td data-bbox="379 1395 1511 1500">A=Actuator LED's An actuator trip is indicated. If more than one actuator is fitted, check which actuator is not working. Check the actuator wiring.</td> </tr> </table>	+ A	A=Actuator LED's An actuator trip is indicated. If more than one actuator is fitted, check which actuator is not working. Check the actuator wiring.
+ A	A=Actuator LED's An actuator trip is indicated. If more than one actuator is fitted, check which actuator is not working. Check the actuator wiring.		



R-net Control

Please refer to your R-net Owner's Manual for details.

9.0 Controller Mounts

9.1 General warnings:

WARNINGS!

- Do not replace the joystick knob with any unauthorised item. It may cause hazardous operation and loss of control of the chair.
- It is important that the joystick boot is replaced if it is torn or brittle; failure to do so could cause substance damage to the controller and unexpected movement of the chair.
- Ensure that you always have comfortable access to the controls whilst the chair is moving and make sure that the controller is fixed securely to the chair.

9.2 Attendant control:

WARNINGS!

- Ensure that you set the speed of the attendant control to a speed that you can comfortably follow.
- Always turn off the power to the controller when leaving the user in the chair. (Fig.9.1).



9.3 Parallel swing-away control:

WARNINGS!

- Before adjusting the swing-away arm, switch off the controller to avoid accidental displacement of the joystick which would cause unwanted movement of your wheelchair.
- Keep your fingers and clothing, etc. clear while operating the swing-away mechanism.
- Be aware that the width of your chair has increased if the swing-away arm is out and you may not get between certain obstacles.
- Do not hang any items on or over the parallel swing-away remote assembly as this could damage the swing-away mechanism.
- When transferring to and from the wheelchair do not use the remote as a means of support.
- Ensure the power is switched off while adjusting the parallel swing-away arm.
- Only operate the wheelchair at low manoeuvring speed when the parallel swing-away is in use, (Fig.9.2).



R-net Control

Please refer to your R-net Owner's Manual for details.



9.4 Centre bar mount control (R-net)

WARNING!

- Make sure that the controller is fixed securely to the centre bar.
- Always turn off the power to the controller before moving the controller out of the way.

9.5 Tray mount control (R-net)

WARNING!

- The maximum weight allowed for the tray is 2.5kg.
- Do not overload the tray; this could cause the tray to break or could cause the chair to become unstable.
- Always turn off the power to the controller before moving the tray out of the way.
- Do not leave lit cigarettes or other heat sources on the tray as this could cause the tray to deform and mark.
- Ensure that all extremities and clothing are free when positioning the tray for use.
- Ensure that you always have comfortable access to the controls whilst the chair is moving and make sure that there is nothing on the tray that could interfere with your control of the chair.

9.6 Swing-away tray mounted centre control (R-net)

The swing-away tray mounted centre control enables the hand control to be flipped over, providing a flat surface when the tray is required and back around when the user requires access to the hand control

NOTE: All warnings for the flip up version are the same as the normal version (section 10.4 above) with the following additional warnings:

WARNING!

- Make sure that the controller is turned off before it is flipped over

NOTE: Be aware that when the controller is flipped to the underside of the tray that driving will be inhibited for the user's safety.



Centre bar mount with R-net Control
Please refer to the R-net Owner's Manual for details of R-net hand control functions.

9.7 Forus control (R-net)

WARNINGS!

- Ensure that you set the speed of the forus control to a speed that you can comfortably follow.
- Ensure that you always have comfortable access to the controls whilst the chair is moving and make sure that the controller is fixed securely to the chair.
- It is important that the joystick boot is replaced if it is torn or brittle; failing to do so could cause substance damage to the controller and unexpected movement of the chair.
- Always turn off the power to the controller when leaving the user in the chair.
- Do not replace the joystick knob with any unauthorised item. It may cause hazardous operation and loss of control of the chair.
- Do not hang any items on the handles of the forus control.

The forus attendant control is a mechanical device that translates mechanical attendant movements into joystick movements on a regular remote control. (Fig 10.3)

The forus attendant control operates with R-net controls only.



Forus with R-net Control

Please refer to the R-net Owner's Manual for details of R-net hand control functions.

After switching on the hand control, the forus attendant control is ready to use. Pushing the handle downwards drives the wheelchair backwards, pushing the handle upwards drives the chair forwards. A left or right push drives the chair in the respective direction.

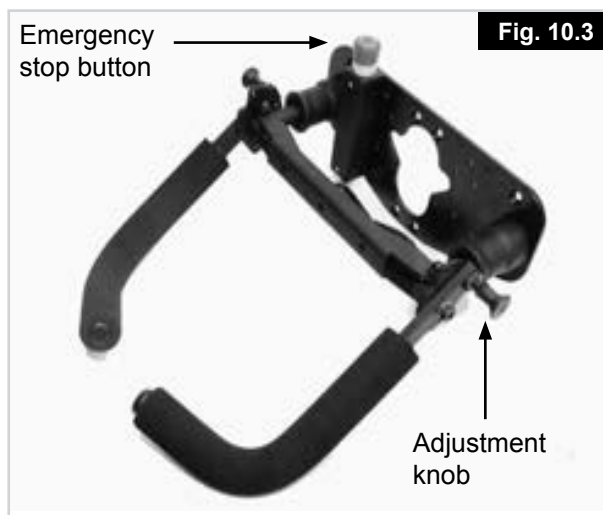

The forus push handle mechanism is centred with springs which will always bring it back to its centre position when the attendant's hands are taken off the handles. The push handles can be adjusted in height by releasing the spring loaded pin on the side, adjusting to the right height position and releasing the pin. (Fig 10.3)

9.8 Emergency stop button

The forus attendant control is equipped with an EMERGENCY STOP button (Fig 10.3). When pressed, it brings the chair to a controlled stop.

When the button is pressed, it automatically locks mechanically in that position. To release twist and pull the EMERGENCY STOP button until it locks into the off position. The chair can now be switched on.

NOTE: Always move the chair with care. If the programming of the attendant drive profile(s) needs adjustments to make it more convenient for the attendant and/or the person sitting in the wheelchair please contact your Sunrise Service agent for adaptation.

If the direction of movement of the forus attendant control needs to be altered please contact your authorised Sunrise Medical dealer for adaptation.

9.9 Powered swing away arm (R-net)

This option (Fig 10.4) is used to mount all chin controls or the sip and puff and can be operated by either a buddy button or ribbon switch

 **WARNING!**

Please be aware of your surroundings before operating the swing-away arm. Make sure that you have sufficient room to your side to prevent damage to your control device and to prevent injury to others.

 **WARNING!**

Please be aware that it is possible to accidentally operate your swing-away arm whilst you are driving your chair. Make sure that you are comfortable with the position of your control switch before using your chair

The powered swing away operates with R-net controls only.

Powered Swing-away with R-net Chin Control



Please refer to the R-net Owner's Manual for details of R-net hand control functions



Fig. 10.4

10.0 Speciality Controls

10.1 Proximity head array

WARNINGS

- The sensors used in this product will operate if moisture of any substance that is electrically conductive is present in sufficient quantities.
- Electro magnetic interference from electrical power lines and certain types of phones will cause the sensors to activate.
- These sensors are capacitive in nature and any material that is conductive will activate them. These sensors are electronic sensors and generate an electronic field which can be affected by liquids and radio frequency interference.
- If the user is caught in the rain or some type of liquid is spilled on the sensor pad, the chair has a great potential to act erratically. Try to activate the stop sensor or shut the chair down if possible.
- Avoid use under high power lines and around cell phones which will interfere with the electronic field generated by the sensor.
- A warning must be conveyed to the wheelchair operator that the chair could come to a sudden stop or act in an erratic manner due to liquids or radio frequency interference (RFI).
- Most electronic equipment is influenced by (RFI). Caution should be exercised with regard to the use of portable communication equipment in the area around where the sensors are located in the head array. If RFI causes erratic behaviour, shut the wheelchair off immediately. Leave off while transmission is in progress.

10.2 Driving with the head array (Fig 10.1)

The head array uses 3 zero touch sensors for driving, one in each head pad.

The sensor in the centre of the headpiece controls forward and reverse.

Sensors in the right and left headpieces are for right and left directional motion respectively.

The fourth switch is the mode switch and it toggles the head array between forward and reverse and between driving the wheelchair and operating any ancillary devices (such as powered seating or augmentative communications systems).



Switching modes

A variety of mode switches are available. These can be divided into three types: internal, hardware mounted and external.

- Internal: mode in left pad or right pad
- Hardware mounted: beam switch
- External: fibre optic, button or mode jack 2. All mode switches perform the same tasks.
- Single click of the mode switch will toggle between forward and reverse.
- A double click of the mode switch will change the operating mode of the system. e.g. standby to drive to actuator etc.

For further details refer to the user manual supplied with your module or contact your Sunrise Medical authorised dealer.

10.3 Proportional head control

Operation of the head control (Fig 10.2)

1. The drive is based on displacement of the headrest. A small amount of pressure must be exerted on the headrest to generate results.
2. Neutral position is when the headrest is not displaced.
3. When the headrest moves right or left, the chair will move in the respective direction.
4. For forward or reverse the headrest needs to be displaced in a backwards direction. Use of the mode switch selects the direction of movement. This will be displayed on the enhanced display module.
5. The greater the displacement of the headrest from the neutral position the faster the chair will go.

For further details refer to the user manual supplied with your module or contact your Sunrise Medical authorised dealer.

Head Controls

Please refer to the R-net Owner's Manual for details of R-net hand control functions



10.4 Sip and puff control and buddy buttons

WARNINGS

- Do not wrap the cable around the switch, wrap the cable separately
- Do not pull on the cable of the switch
- Do not overload your switch connection, adhere to maximum current ratings
- Do not immerse the switch in water
- Do not open or attempt to fix switch
- Do not use solvents to clean your switch, use only a damp cloth or alcohol. The pneumatic tube of the sip and puff can be sterilised in a gas autoclave
- Do not expose switch to extreme heat or cold



For further details refer to the user manual supplied with your module or contact your Sunrise Medical authorised dealer.



Sip and puff (Fig 10.3).

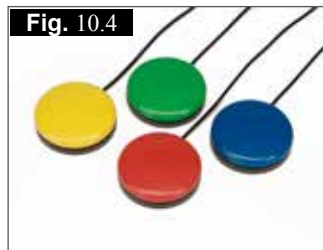

Buddy buttons (Fig 10.4)

10.5 Switch-It mini joystick as a chin control or hand control

The Switch-It mini joystick (Fig .10.5-10.6) is a small joystick which can be handled with little strength (<10 gr.) and little movement.

The Switch-It mini joystick can be adjusted to the needs of the user via extra handles. In combination with mounting kit it's possible to manipulate the mini joystick by finger, hand, tongue, chin, etc.

The joystick is completely protected against moisture, which makes it suitable to use outdoors and when the joystick isn't used for long periods a hood can be placed over it.



10.6 Proportional chin control (Fig.10.7)

The proportional chin control must be used in conjunction with the Omni Plus module. This is to give visual feedback for the selection of drive profiles and seating options.



WARNING!

- Do not replace the joystick knob with any unauthorised item. It may cause hazardous operation and loss of control of the chair.
- It is important that the joystick boot is replaced if it is torn or brittle; failing to do so could cause substance damage to the controller and unexpected movement of the chair.
- Ensure that you always have comfortable access to the controls whilst the chair is moving and make sure that the controller is fixed securely to the chair.



10.7 Micro pilot Joystick

The Micro Pilot joystick is a miniature joystick based on a different technology than other mini "throw" based joysticks. As little as 10 grams of force with virtually no joystick deflection will activate the chair. All internal metal construction means outstanding durability, (Fig 10.8).



R-net, Omni Plus control

Please refer to the R-net Owner's Manual for details of R-net, Omni Plus control functions.

11.0 Batteries and charging



Please read the owner's manual supplied with the charger carefully.



Do not expose any part of the battery to direct heat (i.e. naked flame, gas fire).



When charging always place your charger on a hard surface in a room with good ventilation.



You should not charge your batteries in outdoor conditions.

11.1 Batteries Salsa R2 (Fig. 11.1 - 11.5)

The batteries are contained within the drive unit located under the battery shroud.

To remove the batteries (in case of changing or maintenance) please use the following procedure:

- Remove the rear cover (Fig. 11.1).
- Lift the controller plate up (Fig. 11.2).
- Fold the battery support plate down (Fig. 11.3).
- Disconnect the power connector from the control box, (Fig11.4).
- Pull the battery out and disconnect the the Grey connector, (Fig.11.5).
- Pull the second battery out and disconnect the Grey connector.

To fit the batteries reverse the above procedure.

Fig.11.1



Fig.11.2



Fig.11.3

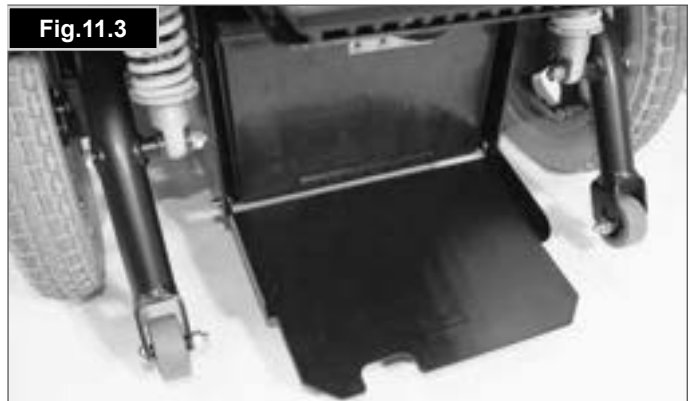

Fig.11.4



Fig.11.5



11.2 Batteries Salsa M2 (Fig. 11.6 - 11.12)

The batteries are contained within the drive unit located under the battery shroud.

To remove the batteries:

- Release the two handle screws under the front of the seat frame that connect the seat frame with the seat module interface.
- Flip the seat frame backwards and secure it with the safety bar, (Fig.11.8).
- Lift off the battery lid.
- Disconnect the 2 pin Anderson connectors from each battery.
- There are straps available on each battery where they can be lifted out with the front battery being removed first.
- To fit the batteries please proceed in the opposite way.

WARNING!

Ensure that the 2 handle screws securing the seat to the base are in place and screwed fully in, (Fig.11.6-11.7).

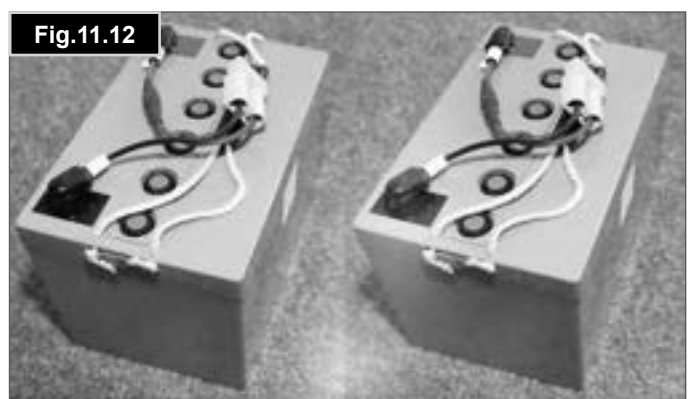
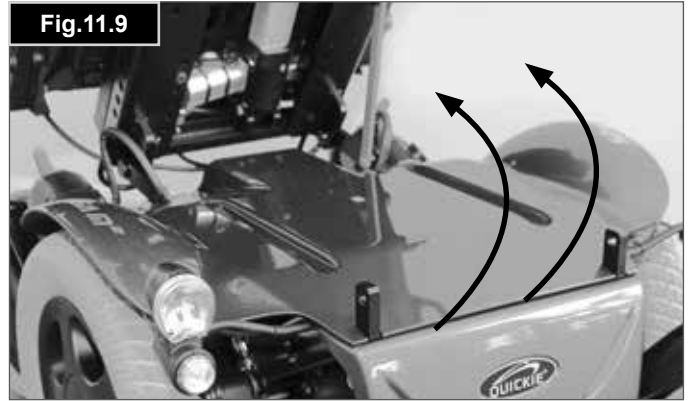
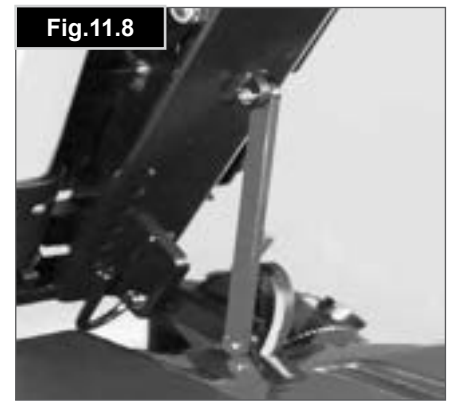

11.3 Safety cut-outs

In the event of a short circuit there are several safety systems built into your wheelchair to safeguard your electrical circuits.

- Fusible 100A links are connected into the battery harnesses to protect the batteries and wiring.
- A 15A fusible link. (When Quickie Direct Actuator Control Box is fitted or other modules requiring auxiliary power). This is located behind the front shroud.

To replace them contact your Sunrise Medical authorised dealer, who will also diagnose the fault.



R-net Control

Please refer to your R-net Owner's Manual for details.

11.4 General battery information

Batteries are the power source for almost all of the modern mobility products available today. The design of batteries used in mobility products is significantly different to the batteries used to start a car for example. Car batteries are designed to release a large amount of power over a short period of time, whilst mobility batteries (commonly called deep cycle batteries) release their power evenly, over a long period of time. Therefore, due to the lower production volumes and increased technological requirements, mobility batteries are typically more expensive.

Commonly two 12 volt batteries are used together in a mobility product, giving a total voltage of 24 volts. The size of the battery (e.g. its available power) is expressed in amps per hour e.g. 80amp/hr. The higher the number, the bigger the battery size, weight and, potentially, the greater the distance you can travel. Sunrise Medical only fit as standard maintenance free batteries into these types of wheelchairs.

11.5 Maintenance free batteries

This type of battery uses a method of carrying the electrolyte commonly referred to as 'gel', that is held within the battery case. As the name implies, no maintenance is required other than regular charging. You can safely transport this type of battery without fear of acid spilling. Furthermore, they are approved for transportation on aircraft, trains and ships.

11.6 Battery care

Below is set out a battery care plan for maintenance free batteries. This has been agreed between Sunrise Medical and the battery manufacturers, to enable you to get the best out of your batteries. If a different care plan is followed, this may result in lower than expected performance from your mobility vehicle.

11.7 Maintenance free battery care plan

WARNING!

Only use an approved Sunrise Medical charger compatible with the vehicle to be charged.

- Charge your batteries every night, regardless of the amount of use your mobility device has had during the day.
- Do not interrupt the charging cycle.
- If your mobility device is not required for use, it should remain connected to the charger until required. This will not damage your batteries, as long as the mains socket/plug is left switched on. Turning the mains socket/plug off, but leaving the mains cable plugged in will eventually deplete your battery charge.
- If you intend to leave your vehicle for an extended period (more than 15 days) charge the batteries fully and then disconnect the main battery lead.

CAUTION!

- Failure to allow for recharge will damage the batteries and can lead to shortened distances and premature failure.
- Do not top up the charge of your batteries during the day. Wait until the evening for a full overnight charge.

As a general rule, maintenance free batteries take longer to fully charge than lead acid batteries.

The battery terminals need to be checked regularly for signs of corrosion. If any corrosion is apparent, then clean the terminals completely (a wire brush is ideal) and re-grease the terminal using Vaseline petroleum jelly, not ordinary grease. Ensure that the terminal nut and bolt, cable clip and exposed cable are completely covered with jelly.

Following all the points above should result in a healthier battery, greater range for the vehicle user and a longer life for your batteries.

Return the batteries back to Sunrise Medical or directly to the battery manufacturer for recycling, when they no longer hold charge.

11.8 General charger information

The external charger has been designed to charge two 12V Gel type batteries connected in series (= 24 V).

11.9 Charger safety features

The chargers have features which prevent hazards or accidents occurring as a result of connecting batteries the wrong way round, overheating caused by fault conditions or attempting to charge wrong voltage batteries.

The majority of charger sizes are electrically double insulated and no earth connection is required. Some larger sizes may be electrically earthed and this will be clearly stated on the label.

The 3 pin UK mains input plug contains a replaceable fuse. The rating of this fuse is shown on the charger label.

WARNING!

Always replace with the same type and size of fuse as specified. Fitting of different fuses can result in damage to the charger or failure of the charger to operate properly.

If your charger has been specified for use in Continental Europe it will contain a European two pin plug which does not have a fuse. In this case the fuse is located in the fascia panel of the charger.

11.10 Connecting the charger and charging

The wheelchair can be charged via the charger socket at the front of the VR2 remote control. (Fig.11.13).

Connect the charger to the mains supply by means of the mains plug and switch on.

CAUTION!

Do not leave the charger connected to the battery with the mains disconnected or switched off. This could result in damage to your battery being caused by deep discharge over a period of time.

WARNING!

Always switch the battery charger off at the mains before connecting or disconnecting it to the wheelchair.

Fig.11.13



11.11 Charger safety and caution notes

WARNING!

- The charger is designed for indoor use. Do not use outdoors or expose to rain, snow, spray or moisture.
- When buying replacement batteries or charger always consult your Sunrise Medical service agent.
- The charger may be used with other brands of Gel type batteries, subject to written confirmation from the Technical Department of Sunrise Medical.

11.12 The range of your vehicle

Most manufacturers of mobility products state the range of their vehicles either in the sales literature or within the Owner's Manual. The range stated sometimes differs from manufacturer to manufacturer even though the battery size is the same. Sunrise Medical measure the range of their vehicles in a consistent and uniform manner, but variances still occur due to motor efficiencies and overall product load weight.

The range figures are calculated to I.S.O. Standard 7176. Part 4: Wheelchair Energy Consumption Theoretical Range

This test is carried out in controlled conditions with new, fully charged batteries, on a level test surface and a user weight of 100 kg. The range figures stated should be seen as a theoretical maximum and could be reduced if any single, or combination, of the following circumstances occur:

- User weight heavier than 100 kg.
- Batteries whose age and condition are less than perfect.
- The terrain is difficult e.g. very hilly, sloping, muddy ground, gravel, grass, snow and ice.
- The vehicle climbs kerbs regularly.
- The ambient temperature is very hot or very cold.
- Incorrect tyre pressures in one or more tyres.
- Lots of start/stop driving.
- Also thick pile carpets within the home can affect range.
- Use of additional power consumption options (e.g. light, actuators, etc.)

The battery sizes available on each Sunrise Medical product should give sufficient range to cope with the majority of customer's lifestyles.

NOTE:

- The available range is directly linked to the battery charge capacity and the Ampere per hour, (Ah), rating of the batteries.
- Battery charge capacity is measured at an ambient 20° Celsius. A temperature higher or lower than 20° Celsius may affect the available battery capacity, which in turn may affect range.

11.13 Common battery statements

Over the years, battery technology has moved forward but, unfortunately, some of the advice given on battery care has not. This has resulted in a number of confused and at times contradictory instructions on the 'best' way to care for your batteries.

This section will help to dispel some of these myths and legends.

WARNINGS!

- To reduce the risk of damage to electric plug and cord, pull by the plug rather than the cord when disconnecting the charger.
- Make sure the cord is located so that it will not be stepped on, tripped over or otherwise subjected to damage or stress.

WARNINGS!

- An extension cord should not be used unless absolutely necessary.
- Use of an improper extension cord could result in a risk of fire and electric shock.
- If any extension cord must be used, make sure the pins on the plug of the extension cord are the same number, size and shape as those of the plug on the charger; and that the extension cord is properly wired and in good electrical condition.
- Do not rest a battery on top of the charger.
- Do not stand the charger on a carpet or other soft surface. Always place it on a hard flat surface.
- Do not operate the charger if it has received a sharp blow, been dropped or otherwise damaged in any way. Take it to a qualified technician.
- Do not disassemble charger; only have it repaired by the manufacturers. Incorrect re-assembly may result in a risk of electric shock or fire.
- To reduce the risk of an electric shock, unplug the charger from the outlet before attempting any maintenance or cleaning. Turning off the controls will not reduce the risk.
- Never place the charger directly above the battery being charged; gases from the battery will corrode and damage the charger.
- Never smoke or allow a spark or flame in the vicinity of battery or charger.
- Be extra cautious to reduce the risk of dropping a metal tool onto the battery. It could spark or short circuit the battery or other electrical parts that may cause an explosion. Also take off all personal metal effects and dangling objects when working on the battery.
- Never charge a frozen battery. A fully charged battery will rarely freeze but the electrolyte of a discharged battery can freeze at -9° Centigrade. Any battery that is suspected of being frozen should be thawed completely before charging.
- Never sit with the charger on your lap when charging your batteries.
- The charger casing will get hot during its normal operation.

11.14 Battery warranty

Battery warranties are subject to periods set by the manufacturers. However, most of these warranties are subject to a wear and tear clause, and if you genuinely wear out your batteries in 6 months, it will not be possible to obtain a replacement under warranty.

12.0 Transportation

A wheelchair secured in a vehicle will not provide the equivalent level of safety and security of a vehicle seating system. Sunrise Medical recommends that the user transfers to the vehicle seating and uses the vehicle-installed restraint system wherever possible. Sunrise Medical recognises that it is not always practical for the user to be transferred and in these circumstances, where the user must be transported whilst in the wheelchair, the following advice must be followed:

12.1 Transportation warnings:

WARNINGS!

- The occupied wheelchair must be located in a forward facing position and secured by the wheelchair tie down and occupant restraint straps (WTORS), meeting the requirements of ISO 10542 or SAEJ2249 in accordance with the WTORS manufacturer's instructions. Refer to the section 'Tie Down Instructions' for further information on transporting your wheelchair.
- The wheelchair's use in other positions within a vehicle has not been tested e.g. transportation in a side facing position must not be carried out under any circumstances, (Fig 12.1).
- Wherever possible remove and stow safely away from the wheelchair, all auxiliary equipment, for example, Kerb climbers, Tray tables, Crutches & Loose cushions.

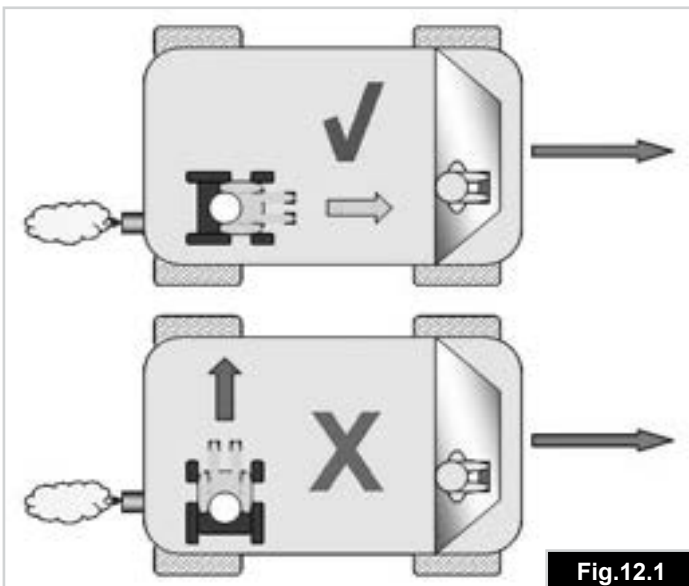

WARNINGS!

- Alterations or substitutions must not be made to the wheelchair securement points or to structural and frame or components without consulting the manufacturer. Failure to do so will invalidate the ability of the wheelchair to be transported within a vehicle.
- The wheelchair should be inspected by a Sunrise Medical authorised dealer before re-use following involvement in any type of vehicle impact.

WARNING!

Both pelvic and upper torso restraint belts must be used to restrain the occupant to reduce the possibility of head and chest impacts with the vehicle components, (Fig 12.2).

WARNINGS!

- This wheelchair has been successfully crash tested. Sunrise Medical recommends that you use a suitably positioned headrest when being transported in the wheelchair. However it is highly recommended that as a preference you transfer from your wheelchair to a seat within the motor vehicle.
- Postural supports (lap straps, lap belts) should not be used or relied on for occupant restraint in a moving vehicle unless they are labelled as meeting the requirements specified in ISO 7176-19:2008 or SAE J2249.
- Spill proof sealed batteries such as "gelled electrolyte" or "AGM" must be installed on powered wheelchairs when used in a motor vehicle.

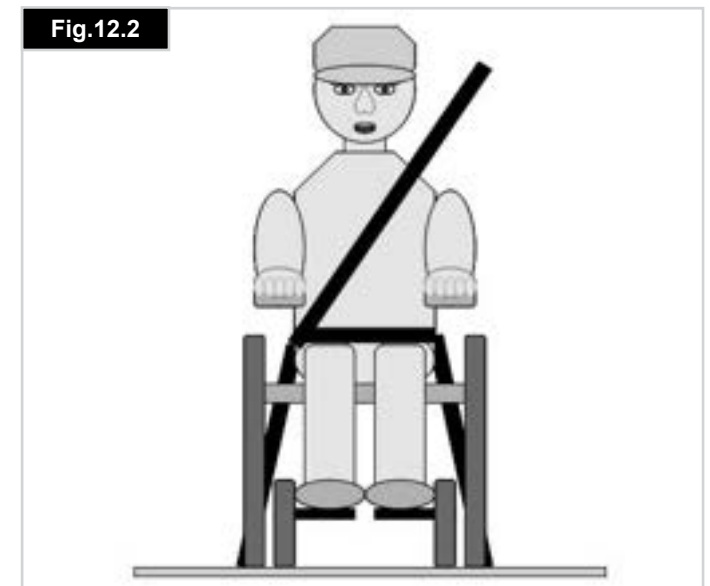

12.2 Occupant restraint instructions

WARNINGS!

- The pelvic restraint belt must be worn low across the front of the pelvis (Fig 12.2) so that the angle of the pelvic belt is within the preferred zone of 30° to 75° to the horizontal, (Fig 12.3).
- A steeper (greater) angle within the preferred zone is desirable i.e. closer to, but never exceeding 75°.
- Restraint belts must not be held away from the body by wheelchair components or parts such as the armrests or wheels, (Fig 12.4).
- The upper torso restraint belt must fit over the shoulder and across the chest as illustrated, (Fig 12.5).
- Restraint belts must be adjusted as tightly as possible consistent with user comfort.
- Restraint belt webbing must not be twisted when in use.

WARNINGS!

- Restraints should not be held away from body by wheelchair components such as armrests or wheels.
- Headrest should be positioned to support the back of the head fully and not rest in the nape of the neck.
- Pelvic restraints should make full contact across the front of the body near the junction of the thigh and pelvis

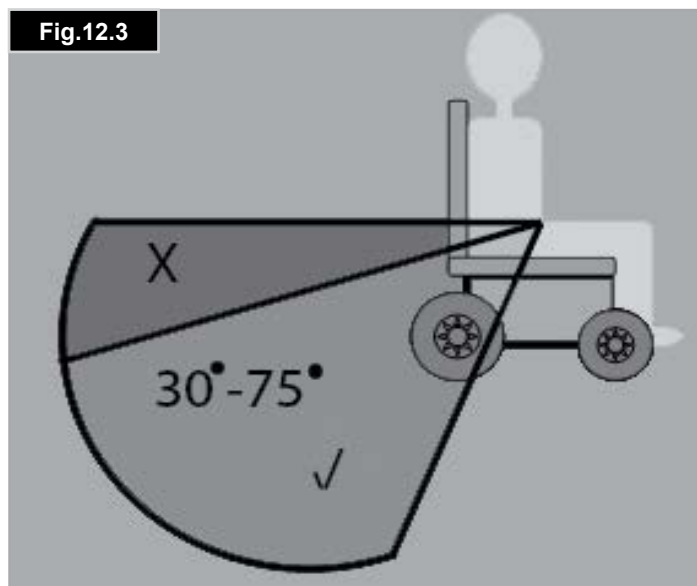

12.3 Special shipping requirements:

The wheelchair may be transported by road, rail, sea or air and the batteries conform to IATA regulations.

CAUTION!

Before you travel, please contact the appropriate carrier. The travel operator will be able to supply details of any special requirements/instructions.

- Ensure that any detachable parts are secured with your mobility aid or separately packed and labelled so they do not get lost during loading and unloading.
- Take this Owner's Manual with you.
- The carrier will need to refer to the following sections.
- How to lock/unlock the Joystick, (Section 7).
- How to disconnect the batteries, (Section 11).
- How to disconnect the drive, (Section 5).

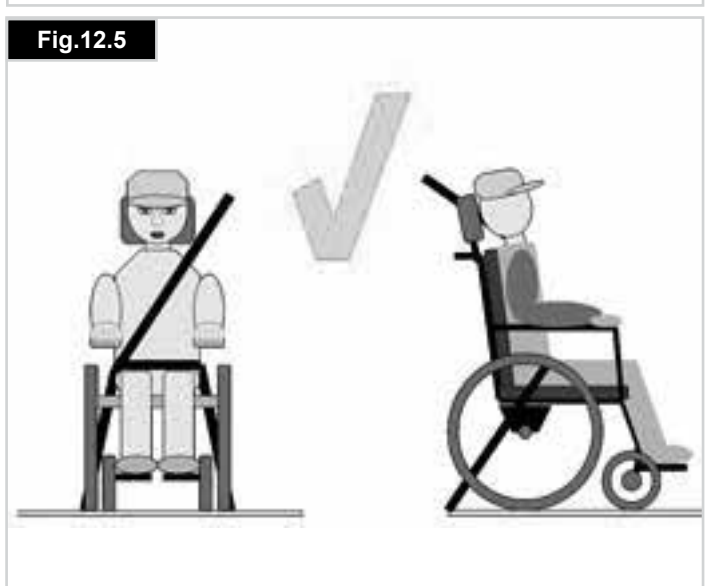
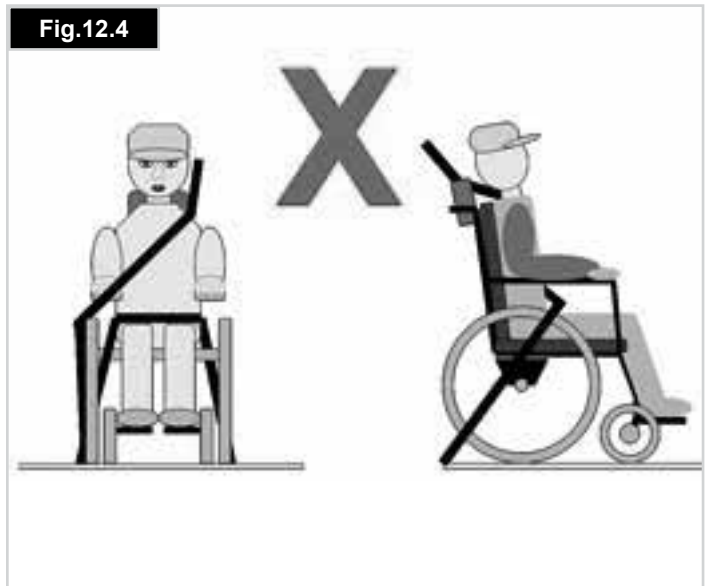

12.4 Crash testing on the SALSA, all models.

A representative SALSA R2 & Salsa M2 wheelchair has been tested in accordance with the dynamic performance requirements specified in ISO 7176-19:2001 "Wheeled Mobility Devices for use in Motor Vehicles" using a Q strait 6 point strap restraint system with double straps at the rear which conform to ISO 10542 or SAE J2249 and was used in accordance with the WTORS manufacturer's instructions.

The Q strait restraint system was used for these tests. However other restraint systems can be used as long as they conform to ISO 10542 or SAE J2249 and are used in accordance with the WTORS manufacturer's instructions. They must also be checked to make sure that they are sufficiently specified for the weight of the wheelchair and rider

WARNINGS!

- All restraint systems must conform to ISO 10542 or SAE J2249.
- All restraint systems must be used in accordance with the WTORS manufacturer's instructions.
- All restraint systems must be checked to make sure that they are sufficiently specified for the weight of the wheelchair and rider

12.5 The tie down label and placement

The label shown in Fig 12.6 is used to identify the tie down points on all chair models.

Fig. 12.7 - 12.10 show the tie down label placements on the SALSA R2 & Salsa M2.

Fig.12.6



Fig.12.7



Fig.12.8

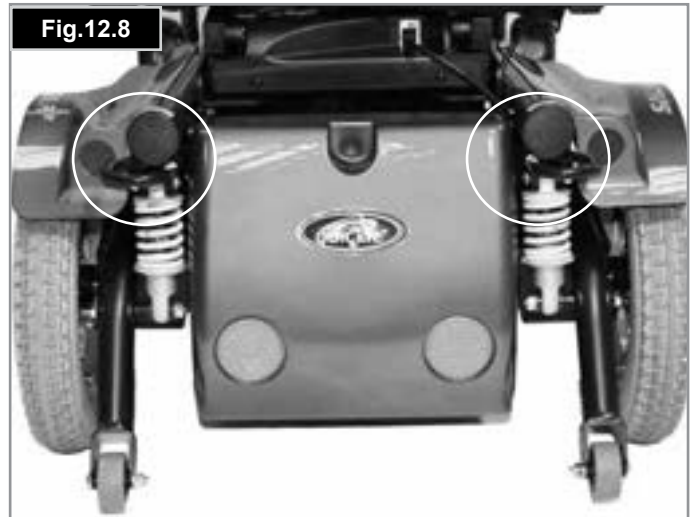

Fig.12.9

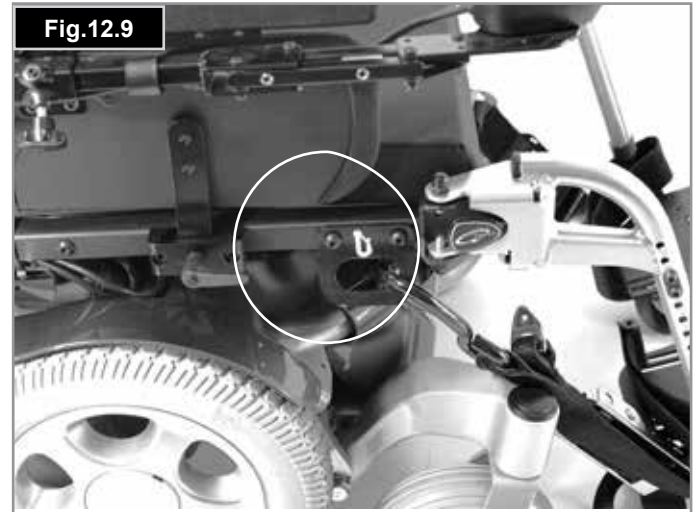

Fig.12.10



12.6 Securing the wheelchair into the vehicle

(Fig. 12.11 - 12.14)

WARNING!

All SALSA wheelchairs (RWD/MWD) require a six-point tie down system for transportation as shown in the photographs.

On the left rear side:

- Use one of the rear tie down restraints, attach it as close as possible on the left rear mounting bracket to an angle of 45°, and tighten securely in accordance with the restraint manufacturers' instructions.
- The second rear tie down restraint should be mounted behind the first restraint and away from the wheelchair.

On the right rear side:

Repeat with the remaining 2 rear straps and attach to the right rear mounting bracket.

At the front:

Attach one front strap to each front tie down point obtaining an angle as close to 45° as possible.

WARNINGS!

- All seating must be returned to its home position with the seat lift fully down and the backrest fully upright.
- Always make sure that the wheelchair is not left in freewheel.

Fig.12.11



Fig.12.12

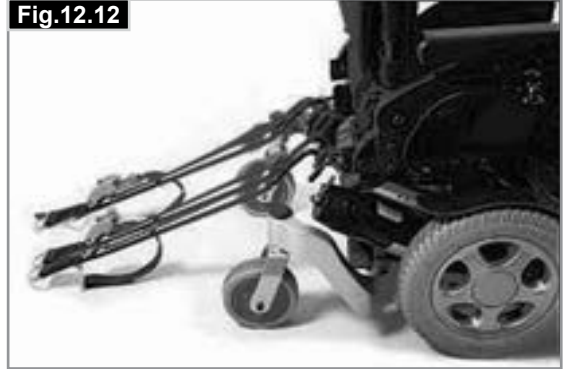

Fig.12.13



Fig.12.14



13.0 Maintenance and Cleaning

CAUTION!

It is important that you follow the following cleaning and maintenance schedule in order to keep your wheelchair in tip top condition.

13.1 Tyre maintenance and pressures

WARNING!

If pneumatic tyres are fitted to your wheelchair it is important to regularly check the air pressure and for signs of wear.

CAUTION!

The correct pressures are between the minimum of 137 kilo Pascals (20 psi, 1.37 bar) and the maximum 241 kilo Pascals (35 psi, 2.41 bar) for rear and front wheels. The pressure will need to vary, depending on the weight of the user.

NOTE: See side of tyre for max pressure and tyre size.

WARNING!

- IT IS IMPORTANT that wheels on a common axle are inflated to the same pressure as a pair, and likewise the rear.
- The inflator pump provides the safest method of inflating your wheelchair tyres and the pressure can be checked with a standard motor vehicle pressure gauge.
- Do not inflate beyond the maximum allowed tyre pressure.

13.2 Tyre wear

WARNING!

Check the tyres weekly.

Bald or damaged tyres can cause punctures or reduce traction, both of these problems can lead to loss of control of the wheelchair.

When inspecting the tyres for signs of wear, look for significant scuff marks, cuts and a diminished tyre tread. Tyres will need to be changed when such damage is evident or if the tread cannot be seen over the complete surface of the tyre.

13.3 Drive wheel tyre repair

WARNING!

Wheel removal and tyre changing is a safety critical task. If you do not feel confident in carrying out the following instructions, please contact your Sunrise Medical Approved Dealer.

- Insert a flat blade screwdriver into the slot & lever the hub cap off, (Fig13.1).
- With the drive wheels still on the ground, use a 6.0mm Allen key to loosen the FOUR studs, (Fig.13.2).
- Lift the wheel off the ground & secure the chair with blocks or stands, (Fig.13.3).
- Use a 6.0mm Allen key to remove the loosened studs, (Fig13.4).
- Lift the drive wheel off the hub, (Fig.13.5).
- Remove the spacer, (Fig.12.6, 14" wheel only).
- Ensure any remaining air is expelled by pressing the valve with a small screwdriver and squeezing the tyre, (Fig.13.7).
- Use a 6.0mm Allen key to undo the FIVE rim studs, (Fig13.8).
- Lift the tyre and tube off the outer rim, (Fig.13.9).
- Gently get hold of the inner tube just behind the valve.
- Carefully feed the tube out of the tyre, (Fig.13.10).

To refit

- Place the tube inside the tyre & rest it on the outer rim
- With the valve stem aligned with the cut out in the rim. Face the valve stem outward, (Fig.13.11).
- Place the inner rim over the tyre, tube & outer rim. Align the cut out to fit over the valve stem & match it up to the cut out in the outer rim, (Fig.13.12).
- Make sure the stud mounts are in line on both rims.
- Tighten the studs in the sequence shown earlier taking care not to pinch the tube.
- Slowly inflate to the pressure marked on the tyre.
- Refit the wheel back onto the motor shaft and fix it safely with the 4-bolts to a torque of 47Nm.

In case a solid tyre is used the wheel needs to be replaced as a complete assembly.

The SALSA solid tyre drive wheel can be removed and repaired/exchanged by following the procedure for removing the drive wheel, as above.





Fig.13.9



Fig.13.10



Fig.13.11



Fig.13.12

13.4 Removing the castor wheel

WARNING!

Castor wheel removal is a safety critical task. If you do not feel confident in carrying out the following instructions, please contact your Sunrise Medical Approved Dealer.

- Note which one of the two holes is used to mount the castor wheel.
- Ensure that both castors use the same mount position.
- Depending on the castor wheel type use two 5 mm hex keys or two 13 mm spanners to undo the axle bolt, (Fig.13.13 & 13.14).
- Remove the nyloc nut in case of the hex bolt type.
- Always use a new nyloc nut when refitting.
- There is an enclosed spacer between the wheel bearings. When refitting do not try to force the bolt through. Gently move the wheel back and forth until the bolt slips through.
- Withdraw the outer spacer, (Fig.13.15).
- Withdraw the axle bolt, (Fig.13.16).
- Remove the castor wheel.
- To refit, reverse the above procedure.
- Tighten to a torque of 19Nm.



Fig.13.13



Fig.13.14

Fig.13.15



Fig.13.16



13.5 Cleaning your wheelchair

The wheelchair should be wiped over once per week with a slightly damp, not wet, cloth and any fluff or dust that has accumulated around the motors should be blown or dusted away.

Make sure that you dry all parts of your wheelchair if it becomes wet or damp after cleaning or if it is used in a wet or damp atmosphere.

WARNING!

It is important that should the wheelchair be used by more than one person it is cleaned thoroughly to ensure there is no cross infection.

13.6 Inspection of the upholstery/seating

Tears, dents, wearing or slackening of upholstery particularly near to metal could result in poor posture or lower levels of comfort and pressure relief.

13.7 Cleaning seating

- You can wash all parts of the covers with a gentle-wash detergent at 40°C.
- You can spin-dry the covers.

CAUTION!

Do not dry the covers in a dryer.

- You can remove all parts of the covers independently of each other and wash them separately.
- Take out the foam inlays prior to washing and close the Velcro fasteners.
- Where upholstery cannot be removed, clean regularly to prevent build up or soiling.
- Clean with a damp soapy cloth however disinfectants may be used in dilution as specified by their manufacturer. Ensure surfaces are rinsed well with clean water and dried thoroughly.

WARNING

Do not use a hose or a pressure washer to clean your chair.

Cleaning instructions for Comfort seating:

- Clean regularly to prevent build up or soiling.
- Clean with a damp soapy cloth and rinse well with clean water.
- Dry the surface thoroughly.
- A soft brush with soapy water may be used to remove stubborn dirt. Ensure surfaces are then rinsed and dried.

Some chemical colourings, e.g. ball point pen, food colourings or clothes dyes should be removed immediately to prevent long term staining.

CAUTION!

Do not use solvents, bleaches, abrasives, synthetic detergents, wax polishes or aerosols. Disinfectants may be used in dilution as specified by their manufacturer. Ensure surfaces are then rinsed with clean water and dried thoroughly.

13.8 Cleaning controls

Clean the control system and the joystick with a cloth dampened with diluted detergent.

CAUTION!

Be careful when cleaning the joystick.
Never use abrasive or spirit based cleaners

Speciality controls

Ensure that wafer boards, joysticks (all variants), head arrays and switches (all variants) are cleaned with a mild disinfectant and a cleaning cloth to avoid any cross infection possibilities. Following removal from chair regularly wash the sip & puff mouth piece and tube to maintain cleanliness and functionality.

WARNING!

Ensure control is switched off before cleaning.

13.9 Lighting maintenance

WARNING!

Maintaining lights and indicators is a safety critical task. If your lights and indicator system shows a defect, please contact your Sunrise Medical Approved Dealer.

All lights and indicators are state of the art LED low energy, no maintenance units. There are no light bulbs used. The high intrinsic reliability of these units means that they are extremely unlikely to fail under normal usage. If a failure should occur, (may be as a result of an impact), the damaged light assembly must be replaced in its entirety. The individual LED's cannot be replaced.

CAUTION!

We recommend the use of Sunrise Medical authorised spare parts only.

NOTE: Be advised that all lighting circuits are electronically protected. In the event of a short circuit current will be limited to a safe level. Once the fault is removed the system resets automatically.

13.10 Electrical connections

When inspecting electrical connections, pay attention to the battery connections, the connection of batteries to power loom and plug in sockets for the joystick, control box and lights and indicators.

13.11 How to connect the cables to the batteries

Also refer to section 11

WARNINGS!

- If you are in any doubt, please contact your Sunrise Medical authorised dealer.
- Batteries are heavy, please use correct lifting techniques and always use the straps provided to lift the batteries.
- No smoking.
- Remove any conductive jewellery such as neck chains, bracelets, watches etc.
- Before connecting the battery terminals it is very important to identify the correct connection for each battery terminal. Failure to adhere to this will result in the wheelchair not functioning or a ruptured fuse.
- Connect all battery terminals before inserting the connectors.
- After connecting battery terminals and connectors ensure all wiring is tidy and cannot get entangled in any moving parts.

SALSA R²

Parts in the battery box, (Fig.13.22):

- Flip down support tray for 2 x 12V batteries.
- 2 x battery looms with fuse and ring terminals.
- Battery link harness with red and grey connectors.

Accessing the Batteries

- Take off the rear cover (Fig.13.17).
- Lift the controller plate up, (Fig.13.17).
- Fold the battery support plate down (Fig.13.18).
- Disconnect the power plug from the control box, (Fig.13.8).
- Pull the battery out, (Fig.13.19).
- Disconnect the Grey connectors.
- Pull the second battery out.
- Disconnect the Grey connector.

To fit the batteries reverse the above procedure.

CAUTION!

Handle the batteries using the straps provided.
Always use correct lifting techniques as batteries are heavy.

The two battery looms are identical. One is required to be connected to each battery:

- To disconnect the batteries, lift up the insulator sleeve & use 11.0mm spanner to undo the bolt. Always fit the insulator sleeve when reinstalling, (Fig.13.20).
- The red wire containing the 100A fuse connects to the battery Positive (+) terminal, (Fig.13.21).
- The other black wire connects to the battery Negative (-) terminal, (Fig.13.20)
- The battery terminals must be covered after connection with the caps provided on the cable.
- Both batteries are fitted to the battery tray with the terminals rear-most, so that the grey connectors can be mated with the battery link harness.
- Ensure the link harness is secured in the slots provided in the tray.
- If you are in any doubt, please contact your Sunrise Medical authorised dealer.

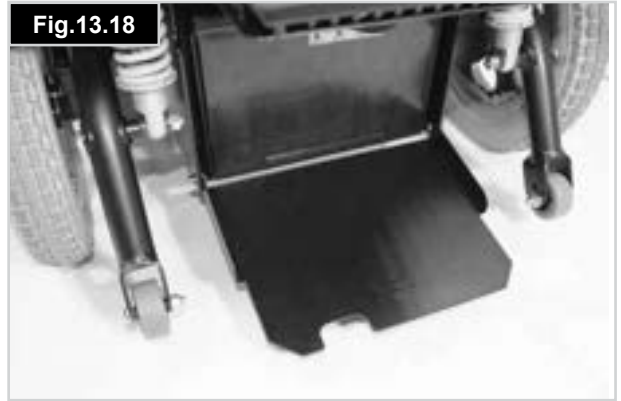

Salsa M²

Parts in the battery box, (Fig.13.22):

- Plastic battery box cover for 2 x 12V batteries.
- 2 x battery looms with fuse and ring terminals.
- Battery link harness with red and grey connectors.

Accessing the Batteries

- Locate & loosen the 2 hand wheels at the front of the power base, (Fig.13.23).
- Carefully tilt the seat back, (Fig. 13.25).
- Support the seat with the seat stay, (Fig.13.25).
- Ensure the seat stay bar is secure.

CAUTION!

- Depending on options, the seat may be heavy to lift. It is recommended that two people carry out this action.
- Avoid pivoting the seat more than 60° rewards.
- The Battery Cover is secured by hook and eye pads located on the body shroud. Use gentle but firm hand pressure to lift the battery cover off.
- Lift the Battery Cover clear.
- Disconnect the GREY plug on the front battery.
- Lift the front battery out using the lifting straps provided.
- Disconnect the GREY plug on the rear battery, (Fig.13.26).
- Lift the rear battery out using the lifting straps provided, (Fig.13.27).
- Peel back the insulative cover and use a 5.0 mm Allan key to undo & remove the terminal bolt. Repeat for the other terminal/battery, (Fig.13.28).
- On refitting, the battery terminals must be covered after connection with the caps provided on the cable, (Fig.13.29).

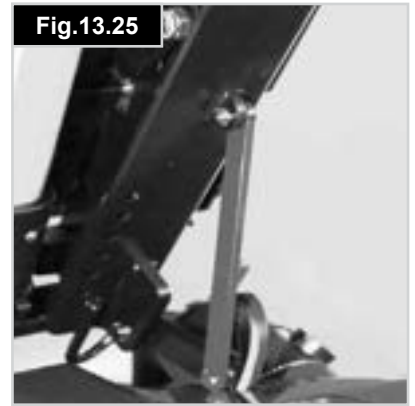

Fig.13.25

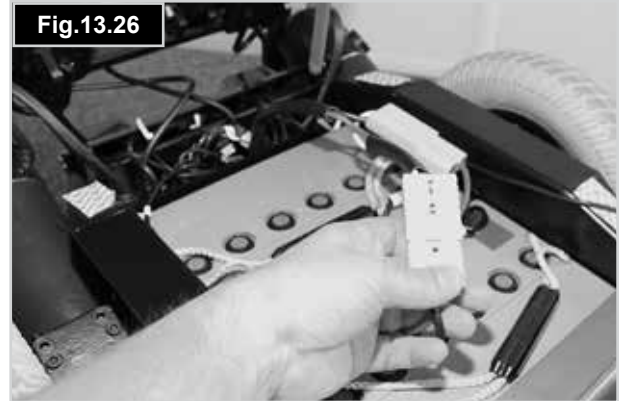

Fig.13.26



Fig.13.27



Fig.13.28



Fig.13.29



Fig.13.23



Fig.13.24

13.12 Controller access

To access the controller on the SALSA R2 (RWD) take the rear shroud off (Fig. 13.30 - 13.31).

To access the controller on the Salsa M2 (MWD) take the rear shroud on the base between the rear castor wheels off. A 4.0 mm Allan key is required. (Fig. 13.32 - 13.33)

13.13 Storage

If you intend to leave your vehicle for an extended period (more than 15 days) charge the batteries fully and then disconnect the main battery lead.

CAUTION!

Never store your wheelchair in direct sunlight or in a damp/outdoor environment. It might bleach plastic parts and components.

13.14 Authorised Sunrise Medical service agents

The annual full service must be performed by an approved Sunrise Medical authorised dealer. For a list of approved authorised dealers in your area please contact Sunrise Medical Customer Service at the address in section 1.0.



13.15 Recommended maintenance routines

(Fig13.35)

Tools required:

Battery charger, Tyre pump, Stiff brush, Petroleum jelly
Cleaning cloth and dilute disinfectant.

WARNING!

If in any doubt about performing any maintenance on your wheelchair, contact your Sunrise Medical authorised dealer.

Daily checks:

With the control system switched off, check that the joystick is not bent or damaged and that it returns to the centre when you push and release it.

Weekly checks:

CAUTION!

Parking brake:

This test should be carried out on a level floor with at least one metre clearance around the chair.

- Switch on the control system.
- Check that the battery gauge remains on, or flashes slowly, after one second.
- Push the joystick slowly forwards until you hear the parking brakes operate. The chair may start to move.
- Immediately release the joystick.
- You must be able to hear each parking brake operate within a few seconds.
- Repeat the test a further 3 times, pushing the joystick slowly backwards, left and right.

Connectors:

Make sure that all connectors are securely mated.

Cables:

Check the condition of the cables and connectors for damage, ensuring that no cables can snag or foul any moving parts.

Joystick gaiter:

Check the thin rubber gaiter or boot around the base of the joystick shaft for damage or splitting. Check visually only, do not handle the gaiter.

Mounting:

Make sure that all components of the control system are securely mounted. Do not over-tighten any securing screws.

CAUTION!

Please refer to the table below, (Fig.13.34), for any information about Torques.

Fastener Matrix	Torque Setting (Nm)
M3 Bolt / Stud	1
M4 Bolt / Stud	2.5 - 3
M5 Bolt / Stud	5 - 6
M6 Bolt / Stud	9 - 10
M8 Bolt / Stud	19 - 20 (15 Nm for all backrest screws)
M10 Bolt / Stud	30 Nm (5Nm on manual & electric backrest recline actuator)
M12 Bolt / Stud	47.5
M16 Bolt / Stud	54
No6 Screw	1.5
Castor fork nut & bolt	25
Castor wheel axle studs	19
Drive wheel hub studs	25

Fig.13.34

The table shown in Fig.13.34 contains generic, (and some specific), torque values set out as an industry standard. There will be specific torque setting required for some tasks. If specific torques are required, the value in each instance will be contained within the text description, title or clearly labelled within the photo.

NOTE: It will be necessary to use a torque wrench.

WARNINGS!

- It is highly recommended that all specific instruction manuals and safety recommendations supplied with the torque wrench, should be read and understood before such equipment is used.
- It is recommended that all mandatory safety procedures are strictly adhered to.
- No responsibility is accepted by Sunrise Medical for any consequence, directly or indirectly, resulting from incorrect use of tools / equipment during any service procedure pertaining to this or other Technical / Workshop Manuals issued by Sunrise Medical.

13.16 Performance checks

After performing any maintenance or repairs on the wheelchair you must make sure that it is functioning correctly before it is used.

- Visually inspect the wheelchair to make sure the legrests, armrests etc are correctly positioned and attached to the wheelchair and all fasteners are sufficiently tightened.
- Make sure that the backrest is correctly fitted and adjusted.
- Make sure that all of the cushions are in place
- Switch on the hand control – Do the lights flash? This signifies that there is a fault in the electronic system. Refer to section 8 for basic troubleshooting.
- Perform the parking brake check.
- Operate all of the electric options, including lights and indicators (if fitted) to make sure that they work correctly.

- With the seating in an elevated position, drive the wheelchair to make sure that the ‘creep’ mode works which will slow the wheelchair.
- Drive the wheelchair in each of the drive profiles to make sure the wheelchair performs as it did before.

CAUTION!

- If you are in any doubt about the performance requirements of your wheelchair contact your Sunrise Medical authorised dealer.
- You should check the items on this chart at the indicated intervals. If any of the items are loose, worn, bent or distorted, immediately have them checked and/or repaired by your authorised Sunrise supplier.
- Frequent maintenance and servicing will improve performance, extend wheelchair life, and help prevent injuries.

Fig.13.35 Maintenance & Inspection Schedule	Daily *	Weekly	Quarterly	Annually
Check battery level indicator and charge if necessary	*			
Check the joystick of the hand control is not bent or damaged	*			
Ensure all parts and assemblies are securely fastened	*			
Check anterior pelvic support for wear and make sure the buckle is operational	*			
Motor Brake Test	*			
Check tyre condition and wheel fasteners.	*			
Ensure lights and indicators, (where fitted), are operational and clean	*			
Ensure all cables and connectors are sound and are tidy and out of the way	*			
Check upholstery, seating, headrests, arm pads and calf pads for wear.	*			
Inspect all nuts, bolts, studs and fasteners for damage and tightness. Contact your authorised dealer for service assistance.	*			
Clean wheelchair upholstery		*		
Check battery terminals for tightness etc.			*	
Complete inspection, safety check and service should be made by a Sunrise Medical authorised dealer				*

* Daily = Before each use of the wheelchair.

14.0 Specification sheets (EN 12184 & ISO 7176-15)

Manufacturers (Europe):
Sunrise Medical GmbH+Co.KG
Kahlbachring 2-4
69254 Malsch/Heidelberg
Deutschland

Operating temperature: - 25°C to 50°C
Storage temperature: -40°C to 65°C
Moisture resistance: IPx4
No restrictions on humidity and air pressure

Model: Quickie Salsa R² (RWD)



Maximum occupant mass (test dummy mass): 140 kg

The wheelchair Quickie Salsa R2 conforms to the following standards:

a) requirements and test methods for static, impact and fatigue strengths (ISO 7176-8)

b) power and control systems for electric wheelchairs requirements and test methods (ISO 7176-14)

c) climatic test in accordance with ISO 7176-9

d) requirements for resistance to ignition in accordance with ISO 7176-16

e) the product is specified as a Class B power chair

ISO7176-15	Min.	Max.	Comments
Overall length (with legrest)	1100 mm	1140 mm	70° hanger
Overall width	600 mm	620 mm	12" / 14" wheels
Folded length	"	"	Not folding
Folded width	"	"	Not folding
Folded height	"	"	Not folding
Total mass (w. batteries)	114.5 kg	160 kg	without Balle/with Balle lift & tilt
Mass of the heaviest part	-	18.5 kg	Heaviest removable part
Static stability downhill	-	> 20°	0° tilt/0° recline/40 cm deep & 50 cm seat height
Static stability uphill	-	10.6°	9° tilt/16° recline & 45 cm seat height
Static stability sideways	-	15.2°	0° tilt/0° recline/40 cm deep & 50 cm seat height
Energy consumption (max. range)	-	32	6 kph motor and 100 kg user (ISO7176-4)
Dynamic stability uphill	-	8 °	9° tilt/16° recline & max. seat height (not with balle)
Obstacle climbing (with kerb climber)	85 mm	100 mm	
Max. speed forward	6 kph	10 kph	6 kph motor & 12.5" wheels/ 10 kph motor & 14" wheels
Min. brake distance from max. speed	-	-	Dep. programming
Seat plane angle	0°	9°	mechanical, 3° increments
Effective seat depth	406 mm	508 mm	25 mm increments
Effective seat width	406 mm	508 mm	25 mm increments
Seat surface height at front edge	375 mm	520 mm	12" wheels / 385 mm 14" wheels
Backrest angle	-4°	16°	mechanical, 4° increments
Backrest height	457 mm	508 mm	25 mm increments
Footrest to seat distance	330 mm	505 mm	
Leg to seat surface angle	110°	-	
Armrest to seat distance	230 mm	305 mm	
Front location of armrest structure	350 mm	425 mm	
Horizontal location of axle	mm	mm	
Min. turning radius	850 mm	910 mm	70° hanger
Nominal battery voltage	24V	-	
Battery cut-off voltage	16V	-	
Battery fusible links	-	-	100A in line fuse on each battery
Quickie Direct Actuator Control Box fusible link	-	-	15A AST Mini Blade
Mass of the test dummy	-	140 kg	
EN 12184	Min.	Max.	Comments
Max. kerb height	85 mm	100 mm	with kerb climber
Ground clearance	70 mm	80 mm	12" / 14"
Turning space	1200 mm	-	
Speed control operation force	-	2N	
Direction control operation force	-	1N	

Model: Quickie Salsa M² (MWD)

NOTE: Salsa M2 is also manufactured in the UK:

Sunrise Medical
Thorns Road
Brierley Hill
West Midlands
DY5 2LD



Maximum occupant mass
(test dummy mass):
140 kg

The wheelchair Quickie Salsa conforms to the following standards:

a) requirements and test methods for static, impact and fatigue strengths (ISO 7176-8)

b) power and control systems for electric wheelchairs requirements and test methods (ISO 7176-14)

c) climatic test in accordance with ISO 7176-9

d) requirements for resistance to ignition in accordance with ISO 7176-16

e) the product is specified as a Class B power chair

ISO7176-15	Min.	Max.	Comments
Overall length (with legrest)	-	1150 mm	with 70° hanger
Overall width	600 mm	660 mm	max. width with seat width adjusted to 51 cm
Folded length	"	"	Not folding
Folded width	"	"	Not folding
Folded height	715 mm	715 mm	Backrest removed
Total mass (w. batteries)	120 kg	145 kg	
Mass of the heaviest part	-	98 kg	Chair with all no tool removal parts taken off
Static stability downhill	-	17°	worst case 41 cm deep seat, 0° tilt, -4° recline
Static stability uphill	-	9.5°	worst case 51 cm deep seat, 29° tilt, 16° recline
Static stability sideways	-	13.9°	worst case 41 cm deep seat, 0° tilt, 0° recline
Energy consumption (max. range)	-	26 km	
Dynamic stability uphill		8 °	9° tilt/16° recline & max. seat height (not with balle)
Obstacle climbing (with kerb climber)		75 mm	Forward with 6 kph motors
Max. speed forward	6 kph	10 kph	10 kph only with 10 kph motor option
Min. brake distance from max. speed	1.0 m	1.2 m	1 m for 6 kph motor, 1.2 m for 10 kph motor
Seat plane angle	-5°	30°	-5° only with MBL tilt + additional brackets
Effective seat depth	410 mm	510 mm	
Effective seat width	410 mm	510 mm	
Seat surface height at front edge	430 mm	470 mm	set 0° tilt, lowest seat height and no modules
Backrest angle	-4°	16°	adjustable in 4° steps with tools
Backrest height	460 mm	510 mm	
Footrest to seat distance	335 mm	610 mm	with 70° hanger
Leg to seat surface angle	110°	-	with 70° hanger
Armrest to seat distance	245 mm	-	adjustable with tools
Front location of armrest structure	310 mm	420 mm	
Horizontal location of axle	mm	mm	
Min. turning radius	670 mm	-	with 70° hanger
Nominal battery voltage	-	24V	
Battery cut-off voltage	-	16V	for 255 seconds
Battery fusible links	-	-	100A in line fuse on each battery
Quickie Direct Actuator Control Box fusible link	-	-	15A blade fuse located on AUX supply of power loom
Mass of the test dummy	-	140 kg	
EN 12184	Min.	Max.	Comments
Max. kerb height	-	75 mm	
Ground clearance	-	40 mm	
Turning diameter	1000 mm	1150 mm	
Speed control operation force	-	2.2N R-Net 2.4N VR2	
Direction control operation force	-	1.7N R-Net 1.9N VR2	

Model: Quickie Salsa R² (Heavy Duty)



Maximum occupant mass with Re-hab seat (test dummy mass): 160 kg

The wheelchair Quickie Salsa conforms to the following standards:

a) requirements and test methods for static, impact and fatigue strengths (ISO 7176-8)

b) power and control systems for electric wheelchairs requirements and test methods (ISO 7176-14)

c) climatic test in accordance with ISO 7176-9

d) requirements for resistance to ignition in accordance with ISO 7176-16

e) the product is specified as a Class B power chair

ISO7176-15	Min.	Max.	Comments
Overall length (with legrest)	1100 mm	1140 mm	70° hanger
Overall width	580 mm	610 mm	12" / 14" wheels
Folded length	"	"	Not folding
Folded width	"	"	Not folding
Folded Height	"	"	Not folding
Total mass (w. batteries)	120 kg	168 kg	without Balle/with Balle lift & tilt
Mass of the heaviest part	-	18.5 kg	Heaviest removable part
Static stability downhill	-	> 20°	0° tilt/0° recline/40 cm deep & 50 cm seat height
Static stability uphill	-	10.6°	9° tilt/16° recline& 45 cm seat height
Static stability sideways	-	15.2°	0° tilt/0° recline/40 cm deep & 50 cm seat height
Energy consumption (max. range)	-	32	6 kph motor and 100 kg user (ISO7176-4)
Dynamic stability uphill	-	8 °	9° tilt/16° recline &max. seat height (not with balle)
Obstacle climbing (with kerb climber)	85 mm	100 mm	
Max. speed forward	6 kph	10 kph	6 kph motor & 12.5" wheels/ 10 kph motor & 14" wheels
Min. brake distance from max. speed	-	-	Dep. programming
Seat plane angle	-5°	30°	-5° only with MBL tilt + additional brackets
Effective seat depth	400 mm	560 mm	
Effective seat width	400 mm	560 mm	
Seat surface height at front edge	420 mm*	480 mm*	* with 12" wheels. Add 10 mm for 14" wheels.
Backrest angle	-5°	12°	mechanical
Backrest height	560 mm	700 mm	
Footrest to seat distance	340 mm	540 mm	
Leg to seat surface angle	110°	-	
Armrest to seat distance	210 mm	300 mm	
Front location of armrest structure	260 mm	560 mm	
Horizontal location of axle	mm	mm	
Min. turning radius	850 mm	910 mm	70° hanger
Nominal battery voltage	24V	-	
Battery cut-off voltage	16V	-	
Battery fusible links	-	-	100A in line fuse on each battery
Quickie Direct Actuator Control Box fusible link	-	-	15A AST Mini Blade
Mass of the test dummy	-	160 kg	
EN 12184	Min.	Max.	Comments
Max. kerb height	85 mm	100 mm	with kerb climber
Ground clearance	70 mm	80 mm	12" / 14"
Turning space	1200 mm	-	
Speed control operation force	-	2N	
Direction control operation force	-	1N	

Model: Quickie Salsa M² (MWD) With Re-hab Seat

NOTE: Salsa M2 is also manufactured in the UK:

Sunrise Medical
Thorns Road
Brierley Hill
West Midlands
DY5 2LD



Maximum occupant mass
(test dummy mass):
160 kg

The wheelchair Quickie Salsa conforms to the following standards:

a) requirements and test methods for static, impact and fatigue strengths (ISO 7176-8)

b) power and control systems for electric wheelchairs requirements and test methods (ISO 7176-14)

c) climatic test in accordance with ISO 7176-9

d) requirements for resistance to ignition in accordance with ISO 7176-16

e) the product is specified as a Class B power chair

ISO7176-15	Min.	Max.	Comments
Overall length (with legrest)	-	1150 mm	70° hanger
Overall width	610 mm	660 mm	12" / 14" wheels
Folded length	"	"	
Folded width	"	"	
Folded Height	715 mm	715mm	Backrest folded
Total mass (w. batteries)	125 kg	176 kg	without Balle/with Balle lift & tilt
Mass of the heaviest part	-	98 kg	Chair with all no tool removal parts taken off
Static stability downhill	-	17°	worst case 41 cm deep seat, 0° tilt, -4° recline
Static stability uphill	-	9.5°	worst case 51 cm deep seat, 29° tilt, 16° recline
Static stability sideways	-	13.9°	worst case 41 cm deep seat, 0° tilt, 0° recline
Energy consumption (max. range)	-	26 km	
Dynamic stability uphill	-	8 °	9° tilt/16° recline &max. seat height (not with balle)
Obstacle climbing (with kerb climber)	-	75 mm	Forward with 6 kph motors
Max. speed forward	6 kph	10 kph	10 kph only with 10 kph motor option
Min. brake distance from max. speed	1.0 m	1.2 m	1 m for 6 kph motor, 1.2 m for 10 kph motor
Seat plane angle	-5°	30°	-5° only with MBL tilt + additional brackets
Effective seat depth	400 mm	560 mm	
Effective seat width	400 mm	560 mm	
Seat surface height at front edge	450 mm	-	
Backrest angle	-5°	12°	mechanical
Backrest height	560 mm	700 mm	
Footrest to seat distance	340 mm	540 mm	
Leg to seat surface angle	110°	-	
Armrest to seat distance	210 mm	300 mm	
Front location of armrest structure	260 mm	560 mm	
Horizontal location of axle	mm	mm	
Min. turning radius	670 mm	-	70° hanger
Nominal battery voltage	-	24V	
Battery cut-off voltage	-	16V	
Battery fusible links	-	-	100A in line fuse on each battery
Quickie Direct Actuator Control Box fusible link	-	-	15A blade fuse located on AUX supply of power loom
Mass of the test dummy	-	160 kg	
EN 12184	Min.	Max.	Comments
Max. kerb height	-	75 mm	
Ground clearance	-	40 mm	
Turning space	1000 mm	1150 mm	
Speed control operation force	-	2.2N R-Net 2.4N VR2	
Direction control operation force	-	1.7N R-Net 1.9N VR2	

15.0 Service History

This section is designed to assist you in keeping a record of any service and repairs to your wheelchair. Should you decide to sell or exchange your vehicle in the future, this will prove most helpful to you. Your Service Agent will also benefit from a documented record and this manual should accompany the wheelchair when service or repair work is carried out. The Service Agent will complete this section and return the manual to you. All our scooters, wheelchairs and power chairs undergo rigorous tests to ensure that they meet our requirements of comfort, safety and durability.

Our success is based on the strong traditions of quality, value for money and genuinely caring for our customers. We pride ourselves not only on designing and building the most innovative products but also on our commitment to offer an excellent standard of customer service both during and after sale.

16.0 Disposal

The symbols below mean that in accordance with local laws and regulations your product should be disposed of separately from household waste. When this product reaches the end of its life, take it to the local collection point designated by local authorities. The separate collection and recycling of your product at the time of disposal will help conserve natural resources and ensure that it is recycled in a manner that protects the environment.

NOTE: Ensure you are the legal owner of the product prior to arranging for the product disposal in accordance with the above recommendations.

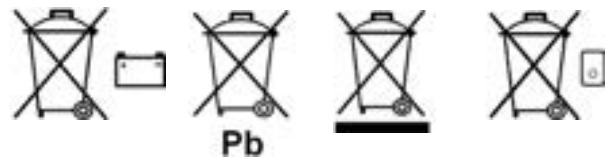

Fig.15.1

Model					Serial No				
Year	1	2	3	4	Year	1	2	3	4
Date					Date				
Controller					Chassis				
Horn					Tightness of All Fasteners				
On/Off switch					Condition				
Output plug					Steering				
Joystick					Upholstery				
Brakes					Seat				
Programme configuration					Backrest				
Batteries					Armrests				
Level					Electrics				
Connections					Condition of loom				
Discharge level					Connections				
Wheels					Test run				
Wear					Forwards				
Pressure					Reverse				
Bearings					Emergency stop				
Wheel nuts					Left turn				
Motors					Right turn				
Wiring					Up/Down slope				
Connections					Over obstacles				
Noise					Parking brake				
Brakes					Note: Only use Sunrise Medical parts for service and repairs				
Brushes									



Dealer signature and stamp:

Fig.16.1

WARNING!

- * BATTERIES CONTAIN ACID AND CAN EXPLODE. ALWAYS WEAR EYE PROTECTION WHEN WORKING NEAR BATTERIES.
- * ALWAYS KEEP BATTERY TERMINALS AND CLAMPS CLEAN AND FREE OF CORROSION.
- * ALWAYS CHARGE BATTERIES IN WELL VENTILATED AREA, AWAY FROM SPARKS AND FLAME.
- * NEVER ALTER BATTERY WIRING OR BATTERY BOX.
- * NEVER ALLOW TOOLS TO MAKE CONTACT ACROSS TERMINALS.
- * NEVER USE BATTERIES OR CLAMPS WITH WING NUT TERMINALS, OR CLAMPS THAT EXCEED TERMINAL POST HEIGHT.

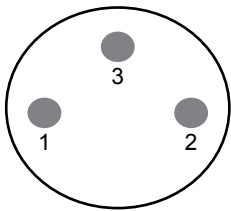
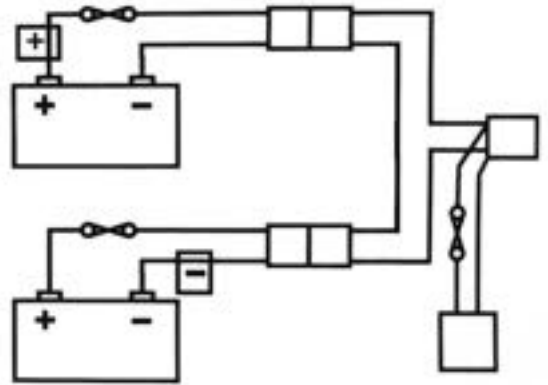
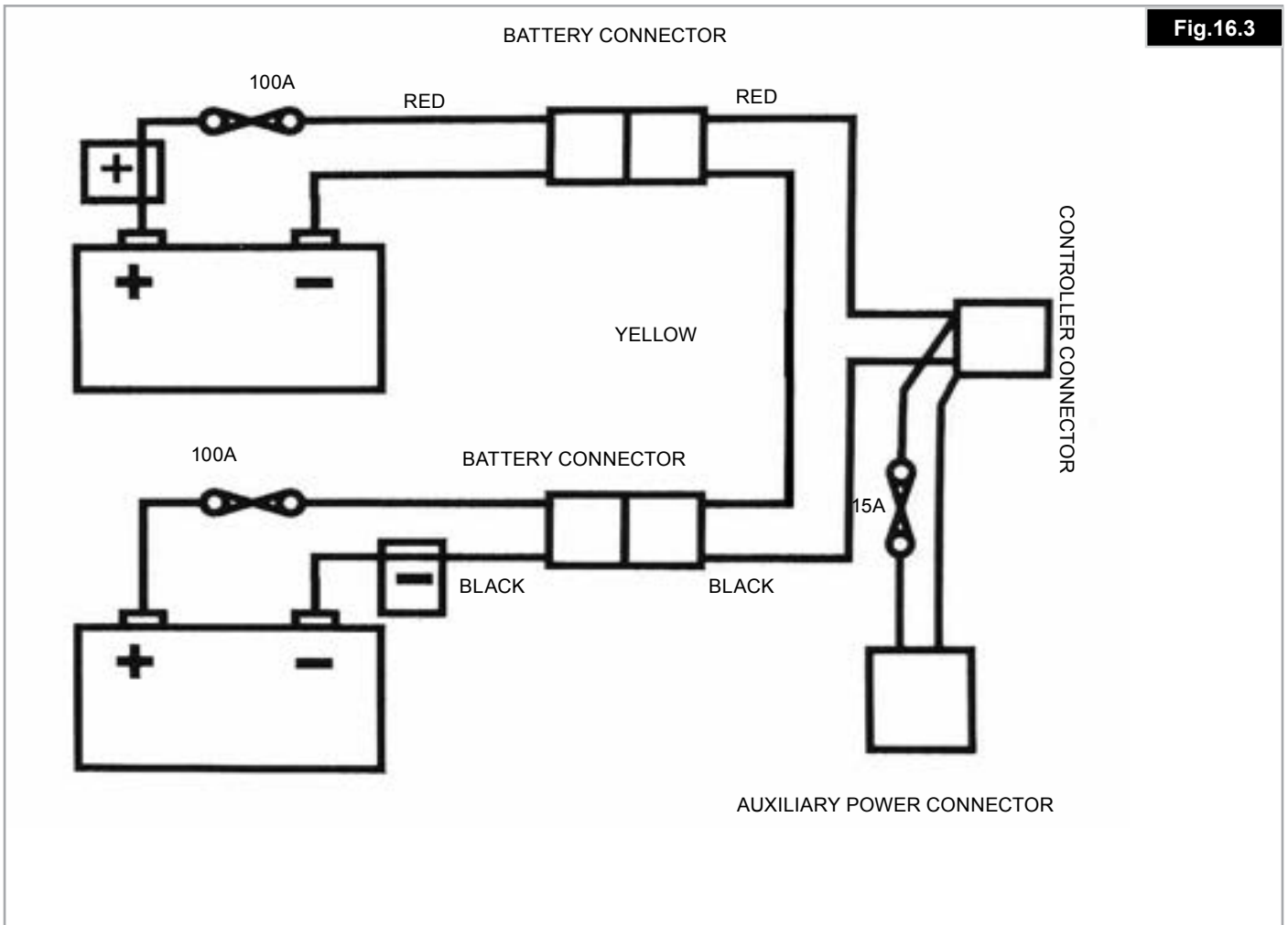

Fig.16.2

Charger Socket:
 Pin 1: Battery Positive
 Pin 2: Battery Negative
 Pin 3: Inhibit

Fig.16.3





Sunrise Medical AS
Dynamitveien 14B
1400 SKI
Norway
Telef: +47 66963800
Faks: +47 66963880
www.SunriseMedical.no

Sunrise Medical AB
Box 9232
400 95 Göteborg
Sweden
Tel: +46 (0)31 748 37 00
Fax: +46 (0)31 748 37 37
www.SunriseMedical.sv

Sunrise Medical GmbH & Co. KG
Kahlbachring 2-4
69254 Malsch/Heidelberg
Deutschland
Tel.: +49 (0) 7253/980-0
Fax: +49 (0) 7253/980-222
www.SunriseMedical.eu
Místní:
Web: www.medicco.cz
e-mail: info@medicco.cz
tel: 800 900 809

PT-keskus Oy,
Koivuhaantie 2-4, 01510 Vantaa,
Suomi
Puh 020 7912 740
Fax 020 7912 759,
ptkeskus@ptkeskus.fi

Türkiye Tek Yetkili Temsilcisi - İthalatçı -
Yetkili Servis İstasyonu:
Destek Rehabilitasyon Teknolojileri Ltd.
Şti.
Cevizlidere Mah., Gökkuşuğu Cad.,
No:23/B, Balgat,
Çankaya – Ankara
Tel: (312) 430 0900
info@destek-r.com.tr

Sunrise Medical Pty. Ltd.
6 Healey Circuit, Huntingwood, NSW
2148,
Australia
Phone: 9678 6600,
Orders Fax: 9678 6655,
Admin Fax: 9831 2244.
Australia
www.sunrisemedical.com.au



Sunrise Medical GmbH & Co. KG
Kahlbachring 2-4
69254 Malsch/Heidelberg
Deutschland
Tel.: +49 (0) 7253/980-0
Fax: +49 (0) 7253/980-222
www.SunriseMedical.de

Sunrise Medical
Thorns Road
Brierley Hill
West Midlands
DY5 2LD
England
Phone: 0845 605 66 88
Fax: 0845 605 66 89
www.SunriseMedical.co.uk

Sunrise Medical S.L.
Polígono Bakiola, 41
48498 Arrankudiaga – Vizcaya
España
Tel.: +34 (0) 902142434
Fax: +34 (0) 946481575
www.SunriseMedical.es

Sunrise Medical Poland
Sp. z o.o.
ul. Elektronowa 6,
94-103 Łódź
Polska
Telefon: + 48 42 275 83 38
Fax: + 48 42 209 35 23
E-mail: pl@sunrisemedical.de
Sunrise-Medical.pl

Sunrise Medical B.V.
Groningenhaven 18-20
3433 PE NIEUWEGEIN
The Netherlands
T: +31 (0)30 – 60 82 100
F: +31 (0)30 – 60 55 880
E: info@sunrisemedical.nl
www.SunriseMedical.nl

Sunrise Medical S.A.S
ZAC de la Vrillonnerie
17 Rue Mickaël Faraday
37170 Chambray-Lès-Tours
Tel : + 33 (0) 247554400
Fax : +30 (0) 247554403
www.sunrisemedical.fr

Sunrise Medical S.r.l.
Via Riva, 20 – Montale
29122 Piacenza
Italia
Tel.: +39 0523 573111
Fax: +39 0523 570060
www.SunriseMedical.it

Sunrise Medical AG
Lückhalde 14
3074 Muri/Bern
Schweiz/Suisse/Svizzera
Fon +41 (0)31 958 3838
Fax +41 (0)31 958 3848
www.SunriseMedical.ch



OM_Salsa R2 - M2_EU_EN_Rev.3.0_2015_05_05

