

UK (English)

Date

Company stamp

User

Folding frame wheelchair

End user weight (kg)

£ 3034,00

Language user manual

Responsible

Retail price - VAT not included

Wheelchair measures

Seat width (LS) 36 39 42 45 48

Seat depth (PS) 37,5 40 42,5 45 47,5
 The real seat depth, from the front part of the seat cloth to the backrest tube will be 1 cm more than the declared one. - calculated with angle backrest 90° to the seat

Footplate distance (DP) (cm) ±0.5cm - adjustment steps 1.5cm
(Real distance between seat and footplate) - IMPORTANT NOTICE! From the footplate to the floor minimum 4cm !! (Minimum Front height = DP + 4cm.)

Setting Standard Prudential Active

Camber 2° 0° 4°

Backrest Height (TS) Std.Value 33,5(min 24.5-max 47) adjustment steps 1.5cm

Backrest angle (to the seat) 90° -6° 6°

Front height (STD 49) - Rear height (STD 43)

Front frame

Frame Angle

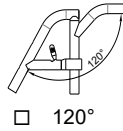
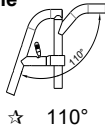

Rear frame

Aluminium standard frame

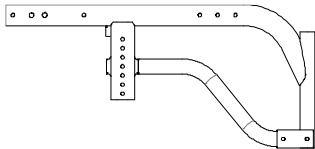

- Short frame - Ideal with Seat depth (PS)37,5 - 40
 Not available for depth 45 - 47,5
- Long frame - Ideal with Seat depth (PS)42,5 - 45 - 47,5

Frame colour

- Bright silver
- Opaque black
- Pearl white

Backrest

Adjustable velcro straps and padded transpiring upholstery

Handle tube

- Tubes with standard handle
- Folding handles



02958 252,00

Casters

- 4" Soft
- 3" Sport
- 5" Soft
- 6" Soft **Not available with frame angle 95°**
- 6" Pneumatic **Not available with frame angle 95°**
- 3" Active Soft (wide) (Aluminium alloy rim) 06824 126,00
- 4" Active Sport (narrow) (Aluminium alloy rim) 01398 126,00
- 4" Active Soft (wide) (Aluminium alloy rim) 03943 126,00
- 5" Active Soft (wide) (Aluminium alloy rim) 07518 126,00
- 5" Pneumatic 10844 63,00

Support front fork

Standard support front fork



Colour set: Rear wheels and forks - To be matched only with: Rear wheels Ultra-light Progeo - Standard! (22 - 24)

- Polished black 22" 24" 25" 26" 00833 126,00
- Bright silver 22" 24" 00833 126,00
- Bright anthracite 24" 00833 126,00
- Bright orange 22" 24" 00833 126,00
- Bright fuchsia 22" 24" 00833 126,00
- Bright blue 22" 24" 00833 126,00
- Bright red 22" 24" 00833 126,00
- Bright lime 22" 24" 00833 126,00
- Pearl white 22" 24" 00833 126,00

Date Order User Address

Rear wheels

- ☆ 24" Ultra-light Progeo - Standard! 04383 **876,00**
- 22" Ultra-light Progeo - Standard! 01685 **876,00**
- 25" Ultra-light Progeo - Standard! 07846 **876,00**
- 26" Progeo - Standard! 02270 **1.374,00**
- 24" ULTRA-LIGHT PROGEO KEY SPORT **Weight reduction approx. 450gr.** 02101 **876,00**
- 24" Ultra-light "Spinergy LX" 07847 **876,00**
- 24" Ultra-light "Spinergy LXL" 02102 **876,00**
- 24" Ultra-light "Spinergy Flex rim" 01392 **224,00**
- 25" Ultra-light "Spinergy LX" 03385 **360,00**
- 25" Ultra-light "Spinergy LXL" 03384 **360,00**
- 26" Ultra-light "Spinergy LX" 02103 **401,00**
- 24" Off-road (aluminium handrim black)
- 22" with brake handles for companion (drum brake) (aluminium handrim)
- Available only with: camber 0° and Setting Standard**
- 24" with brake handles for companion (drum brake) (aluminium handrim)
- Available only with: camber 0° and Setting Standard**
- One arm drive - (24" rear wheels Aluminium handrim High pressure Tyre) - camber 0°
- Right Left

Rear wheel tyre

- ☆ High pressure tyre (22"-24"-25"-26")
- High pressure profile tyre (24")
- Marathon Plus (24"-25") **with anti-puncture protection** 01669 **63,00**
- Anti-puncture - Colour Black (24") 11083 **126,00**
- Anti-puncture - Colour Grey (22") 04181 **98,00**

Handrim





Wheel distance ☆ 3 cm 4 cm

- ☆ Aluminium (22"-24"-25"-26") 09170 **126,00**
- Aluminium black SOFT-TOUCH (24"-25") **(24" handrim, on 25" wheel is installed with spacers)** 01684 **148,00**
- Chromed Steel (24"-25") **(24" handrim, on 25" wheel is installed with spacers)** 00016 **275,00**
- Titanium (24"-25") **(24" handrim, on 25" wheel is installed with spacers)** 00017 **315,00**
- Ultra Grepp (24"-25") **(24" handrim, on 25" wheel is installed with spacers)** 00834 **349,00**
- Max Grepp (24"-25") **(24" handrim, on 25" wheel is installed with spacers)** 00632 **349,00**
- Ergo Para (24") 11023 **399,00**
- TOP FRICTION (24"-25") **(24" handrim, on 25" wheel is installed with spacers)** 11025 **263,00**
- Oval countour with a rubber insert**
- NOVA H (24"-25") **(24" handrim, on 25" wheel is installed with spacers)** 11026 **286,00**
- Ergonomic black profile**
- NOVA D (24"-25") **(24" handrim, on 25" wheel is installed with spacers)** 06427 **360,00**
- Ergonomic profile with rubber coating (ideal for quadriplegics)**
- SURGE LT (25") **Oval countour with a rubber insert** 00693 **200,00**
- Quad (24") 04050 **160,00**
- Silicon cover for standard aluminium handrim Available for measures (22"- 24" - 26")

Wheel locks

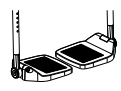
- ☆ Bent lever push to lock 
- Straight lever push to lock 
- Straight lever pull to lock 
- Sport brake 06428 **126,00**
- Brake with extension lever push to lock 01949 **63,00**
- Brake with extension lever pull to lock 03372 **63,00**

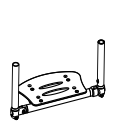
Footplate - See reference tables N°3

- ☆ Plastic footrest rake adjustable  11525
- Minimum footplate distance 35cm.** ☆ 2/3 Internal 2/3 External
- One piece footplate - Flip-up! rake and depth adjustable  11527
- Minimum footplate distance 35cm.** Internal ☆ 2/3 Internal External
- **Minimum footplate distance 30cm. Available only with Multi-function and rotative system - 03945 189,00**
- One piece aluminium footplate - Flip-up! rake and depth adjustable  11528
- Minimum footplate distance 35cm.** Internal ☆ 2/3 Internal 2/3 External External
- One piece Carbon fibre footplate rake adjustable, swing away, flip-up.  03291 **275,00**
- Minimum footplate distance 35cm.** Internal External

Date Order User Address

Mudguard

Mudguard

- ABS mudguard
- ABS Straight sideguard
- Carbon fibre mudguard
- Carbon fibre Straight sideguard

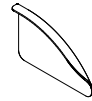

03946 **315,00**
08918 **315,00**

Removable version

- Removable ABS mudguard
- Removable ABS fibre straight sideguard
- Removable carbon fibre mudguard
- Removable Carbon fibre straight sideguard



08921 **126,00**
08921 **126,00**
08919 **435,00**
08920 **435,00**

Armrests

- Tubular armrests - Steel support with safety locking system
(Swing away, removable and height adjustable armrest)



00694 **252,00**

Removable armrest with ABS mudguard

- Desk armrests PROGEO (Removable and height adjustable)
- Removable armrest with ABS straight sideguard
- Removable armrest with carbon-fiber straight sideguard

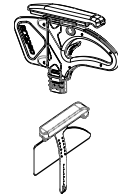

09956 **224,00**
08881 **224,00**
08882 **453,00**

Accessories

- Pad for front frame protectors
- Backrest-seat connection cloth
- Removable storage bag (with quick coupling)

07058 **52,00**
10241 **17,00**
09811 **126,00**

Optional 1

Only one optional devices for side can be chosen

- Transit wheels **Exclude the installation of :
Anti-tippers -Tipping aid - Crutches support**
- Anti-tipper with rapid hookup (inside rotation to reduce the encumbrance)
 - Right
 - Left
- Tipping aid
 - Right
 - Left
- Crutches support
 - Right
 - Left



00836 **148,00**
00023 **126,00**
00024 **126,00**
00025 **74,00**
01046 **74,00**
00838 **74,00**
00837 **74,00**

Optional 2

- Tetraclip (Quick release axle for quadriplegic) 03947 **177,00**
- Quick release front forks To be matched only with: Standard support front fork 00030 **148,00**
- Push handles for companion (Removable and height adjustable) 01048 **189,00**
- Safety pelvic belt 03972 **63,00**
- Harness 04103 **126,00**
- Lumbar support (to insert in the backrest upholstery) 00013 **40,00**
- Swing away lateral support
 - Right 02097 **252,00**
 - Left 02098 **252,00**
 Not available with Posture backrest PHYSIO
- Spoke guards Black (22"-24") 01043 **148,00**
- Spoke guards Transparent (22"-24") 00835 **148,00**
- Spoke guards Progeo design (22"-24") 00019 **177,00**
- Spoke guards Dragon (22"-24") 02106 **177,00**

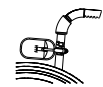

Additional Kit





- 24" Off-road rear wheels Off-Road tyre - aluminium handrim (black colour) 03378 **498,00**
- 24" FAT rear wheels FAT tyre 3" - aluminium handrim (black colour) 09357 **876,00**

Date Order User Address

PHYSIO - Posture backrest (Std. Backrest upholstery not provided)





Removable with quick release
Suitable for tubes with diameter 18+26mm
Depth adjustment (4cm)
Angle adjustment ($\pm 18^\circ$)

- AIR** Carbon shell
not available for seat width 48

BACKREST HEIGHT	28	34	40	
Shell's shape  7.5 cm	Lateral retaining wing A=high - R=regular			
	A	R	A	R
				
	<input type="checkbox"/>	<input type="checkbox"/>	<input type="checkbox"/>	<input type="checkbox"/>

1.047,00

- POSTURE** Aluminum shell

BACKREST HEIGHT	34	40	52	
Shell's shape  7.5 cm	Lateral retaining wing B=regular			
		R	R	R
	<input type="checkbox"/>			
		<input type="checkbox"/>	<input type="checkbox"/>	<input type="checkbox"/>

#####

Configuration DEEP with side support PAD (height adjustable)

- Aluminum lateral with padded, breathable upholstery.



Small (h 13cm)



Right 10272

29,00



Left 10272

29,00

Large (h 20cm)



Right 10273

40,00



Left 10273

40,00

SWING AWAY - Lateral support

Fixing and adjustment hardware complete with protection sleeve
Aluminum lateral with padded, breathable upholstery.

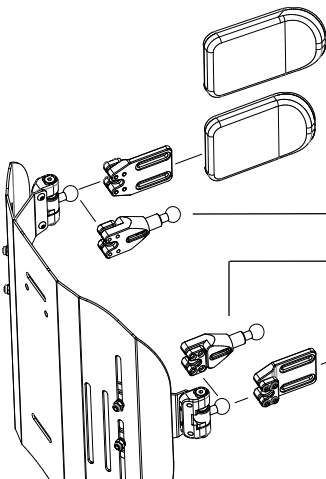

- Large (18x12)

05647 183,00

- Small (14x9)

05643 183,00

- Lateral support extension

Quantity (number pcs)..... 10271 69,00

- Lateral support extension

Quantity (number pcs).....

- Small (14x9)

05642 183,00

- Large (18x12)

05646 183,00

- Headrest adjustable - Double ball mounting system
Available only with backrest Physio
Not available for backrest Physio AIR carbon shell



Large (34x14) 05648 252,00
 Small (28x14)

Date Order User Address

Permobil Limited Unit 7, Polaris Centre, 41 Brownfields, Welwyn Garden City, Herts, AL7 1AN United Kingdom - Phone: +44 1484 722888

customer_support_uk@permobil.com - https://www.permobil.com/en-gb



Note

Wheelchair : Progeo TEKNA ADVANCE SWING with footrests removable and Swing away - Rev. 2023.1

Prices - VAT excluded
to be added to the price list

Send this page only if any optional have been chosen	
★	standard (supplied if no requests are indicated)
<input type="checkbox"/>	on request (without extra charge)
<input type="radio"/>	optional (cost to be added at the basic price)

REFERENCE TABLES

1 Front height					
With closed frame (95°) max 5" caster					
FORK	Casters				
	3"	4"	5"	6"	
SMALL 	min. 39 max 42	min. 40 max 43	min. 42 max 43	min. 44 max 45	
MEDIUM 	min. 43 max 45	min. 44 max 46	min. 44 max 47	min. 46 max 48	
LONG 	min. 46 max 52	min. 47 max 53	min. 46 max 54	min. 47 max 55	
The size of the fork will be defined only by Progeo in accordance with wheelchair final configuration.					

2 Rear height				
	Rear wheels			
	22"	24"	25"	26"
H min	min. 36	min. 38	min. 39	min. 40
H max	max 44	max 48	max 49	max 51

3	Footplate option	Footplate distance
	Elastic footrest.....	min. 36.....
	One piece footplate - Flip-up!, with multifunction rotative system	min. 31
	One piece aluminium footplate - Flip-up!	min. 36
	One piece footplate - Flip-up!	min. 36
	One piece Carbon fibre footplate	min. 36
Calculated with the best configuration and with the footplates positioned on inside.		
IMPORTANT NOTICE! From the footplate to the floor minimum 4cm !! (Minimum Front height = DP + 4cm.)		

4	Rear wheels	
	Model	Features
	22" Ultra-light Progeo - Standard!	(not available in anthracite color)
	24" Ultra-light Progeo - Standard!	(available for all colors)
	24" ULTRA-LIGHT PROGEO KEY SPORT	(silver hub, black rim and 16 spokes)
	24" Ultra-light "Spinergy LX"	(silver hub, black rim and spokes)
	24" Ultra-light "Spinergy LXL"	(black hub and rim, 18 white spokes) - (black hub, rim and 18 spokes)
	24" Ultra-light "Spinergy Flex rim"	(silver hub, black rim and spokes) - (integrated aluminium/rubber handrim - encumbrance reduction up to 3cm. - all tyre)
	24" Off-road	(colour: black) - (aluminium handrim - tyre Off-road)
	25" Ultra-light "Spinergy LX"	(silver hub, black rim and spokes)
	25" Ultra-light "Spinergy LXL"	(black hub and rim, 18 white spokes)
	26" Progeo - Standard!	(colour: black)
	26" Ultra-light "Spinergy LX"	(silver hub, black rim and 18 spokes)

Wheelchair : Progeo TEKNA ADVANCE SWING with footrests removable and Swing away - Rev. 2023.1