



Activity wheelchair with rigid framework and detachable and swiveling leg support

Included in the base price:

- by standard growable in SW, SD and BH without change of frame parts
- Straight or abducted frame
- Pneumatic or solid tyres
- Standard push handles (long)
- Adjustable seat and back cover
- Standard knee lever brake

Quotation Order

Weight capacity: 120 kg
German aid index N° 18.50.03.6005

Base price £2,869

Prices excl. VAT, valid from 01.03.2021

Delivery address / Company stamp		Billing address: <input type="checkbox"/> same as delivery address	
Name:		Name:	
Address:		Address:	

Ordering information:	
Reference/ internal description:	Date:
Contact person:	Signature:

Frame		Displacing the back tubes (possible from SD 38 cm) for seat shell build	
Leg/foot space	Frame height		
<input type="checkbox"/> Straight frame from SW28 	<input type="checkbox"/> Standard height	<input type="checkbox"/> Adapter to displace the back tubes by 4 cm back. (without seat and back cover, incl. seat supporting angle and stabilizing rod). With this, the seat depth becomes longer (distance front edge seat to back tube) by 4 cm and you gain more room toward the back for example, the build of a seat shell. Not possible in combination with the wheel base extension (N° 7601). In the spot seat depth DO NOT state the actual seat depth of the user, but the needed measurements for the user's seat depth PLUS the build of a seat shell. e.g.: actual seat depth of the user = 36 cm, build depth seat shell = 8 cm 36 cm + 8 cm = 44 cm, your indicated seat depth = 44 cm	
N° 596996 £ 0	N° 596992 £ 0		
<input type="checkbox"/> Abducted frame + 6 cm 	<input type="checkbox"/> XL height (frame height + 4 cm) Possible for seat depths: 44, 46, 48 and 50 cm		
N° 596997 £ 0	N° 596993 £340	N° 596995	£200

Measures (Please note our information page „Configurations and Adjustments“ at the end of this order form)				
Seat width (N° 10..)	Seat depth (N° 11..)	Back height (N° 12..)	LLL / Seat height	Degree of activity
+ 4 cm extension each <input type="checkbox"/> 30 <input type="checkbox"/> 32 <input type="checkbox"/> 34 <input type="checkbox"/> 36 <input type="checkbox"/> 38 <input type="checkbox"/> 40 <input type="checkbox"/> 42 £ 0	+ 4 cm extension each Frame size: Size 1: <input type="checkbox"/> 34 <input type="checkbox"/> 36 Size 2: <input type="checkbox"/> 38 <input type="checkbox"/> 40 <input type="checkbox"/> 42 <input type="checkbox"/> 44 £ 0	back tube Standard + 5 cm extension each <input type="checkbox"/> 30 (...30) <input type="checkbox"/> 35 (...35) <input type="checkbox"/> 40 (...40) <i>not possible with tarta - back</i> £ 0	1. Real lower leg length of the user (LLL): _____cm 2. Cushion thickness (CT) _____cm £ 0	<input type="checkbox"/> 1 <input type="checkbox"/> 2 <input type="checkbox"/> 3 <input type="checkbox"/> 4 Position 1 = very passive Position 4 = very active The degree of activity corresponds to the axle plate position on p.16. The combination of certain components might cause restrictions; in this case the next possible degree of activity will be chosen.
<input type="checkbox"/> 44 <input type="checkbox"/> 46 £165	Size 3: <input type="checkbox"/> 46 <input type="checkbox"/> 48 <input type="checkbox"/> 50 AC not with XL height £165	back tube reinforced + 5 cm extension each <input type="checkbox"/> 30 (...302) <input type="checkbox"/> 35 (...352) <input type="checkbox"/> 40 (...402) <input type="checkbox"/> 45 (...452) <input type="checkbox"/> 50 (...502) <i>recommended for increased pressure (e.g. Spasticity etc.). Not possible with tarta - back.</i> £89	Seat height back: _____cm Seat height front: _____cm cf. table on p. 16	

Colours		
Finish alternatives	Moderate metallic effect (except for Black & King's Blue)	Special colours (without additional charge, except for Nightblue)
<input type="checkbox"/> Shiny £ 0 <input type="checkbox"/> Matt Not possible with special colours! N° 1561 £75	<input type="checkbox"/> Zinc Yellow (02) <input type="checkbox"/> Dark Green (15) <input type="checkbox"/> Pure Orange (21) <input type="checkbox"/> Crimson (04) <input type="checkbox"/> Pastel Blue (20) <input type="checkbox"/> Dark Blue (16) <input type="checkbox"/> Brilliant Blue (08) <input type="checkbox"/> Cream White (17) <input type="checkbox"/> Girly Pink (19) not metallic: <input type="checkbox"/> Chrome Yellow (06) <input type="checkbox"/> Black (31) <input type="checkbox"/> King's Blue (32)	Strong metallic effect: <input type="checkbox"/> Silver Metallic (36) <input type="checkbox"/> Anthracite Metallic (22) <input type="checkbox"/> Coarse Black (27) Dormant colours: <input type="checkbox"/> Apple Green Dormant (18) <input type="checkbox"/> Fire Red Dormant (45) <input type="checkbox"/> Violet Dormant (50) Dormant col. with additional charge: <input type="checkbox"/> Nightblue Dorm. (47) £65

Design package color anodization (Colour examples for anodized colours can be found on our website in the area equipment)		
<input type="checkbox"/> anodized Blue (01) <input type="checkbox"/> anodized Red (02) <input type="checkbox"/> anodized Green (03) <input type="checkbox"/> anodized Gold Orange (04) <input type="checkbox"/> anodized Violet (05) N° 1571.. £250	The following parts are anodized: Assembly group caster (fork, caps, adapter, half shells, wheel spacer), hand rims The design package ist only possible in the listed setting.	Restrictions: The hand rims are only available in the design package anodized colours by choosing aluminum hand rims. (not possible with stainless steel, Maxgrepp, PVC, double, nob or ergonomic hand rims. Also not possible with profile wheels).

Seat system		Tarta® back system	
Nylon seat cover	SeatFix	Adaptation holder	Example for Tarta® back rest
			<p>Tarta® is an ergonomic back rest that offers best solutions in terms of adaptability. With the SORG adaptation holder you can adapt a Tarta® back rest easily.</p> <p>Order information for Tarta® back systems at www.tartadesign.it/en/distributor/</p>

Back angle				Fitting set
Standard straight	Screwing	Raster	Gas pressure spring	for solid back
Back angle Standard 90° 	adjustable with screwing 	adjustable with raster 		required for mounting a solid back that is manufactured by specialist trade

Curved back plate			Retractable back extension	
Model 1	Model 2	Model 3		
Straight upper edge, 2 cm higher than back height	Straight upper edge, 10 or 20 cm higher than back height	Curved upper edge, 5, 10 or 15 cm higher than back height		

To see the latest versions of our order forms, please visit www.sorgrollstuhltechnik.de/download-portal

Seat system		Back unit	
Nylon seat cover		Strap system	
<input type="checkbox"/> Adjustable strap system, black N° 1913 £ 0		<input type="checkbox"/> Adjustable strap system, incl. breathable cushion (thickness 2 cm) in chosen cover colour (page 5). We recommend a stabilizer bar (N° 6408) for higher stability.	
Seatplate		Back angle	
<input type="checkbox"/> Firm aluminium seat plate for optimized support of pelvic, firmly bolted N° 1908 £182		<input type="checkbox"/> Standard back unit, 90°, straight N° 6237 £ 0 <input type="checkbox"/> Back angle adjustable in steps manually from 80°-120° and completely stowable; incl. stabilizer bar N° 6408 N° 6109 £249 <input type="checkbox"/> Back angle firmly adjustable by screw connection at 80°-105°, incl. stabilizer bar N° 6408 N° 6231 £149	
		<input type="checkbox"/> Back angle steplessly adjustable by 30° with gas pressure spring, incl. stabilizer bar (from BH 35). Extendable push handles and anti tipper required! Not with N° 596995 (Adapter to displace the back tubes) Not approved for transport in a disabled person transport vehicle! Desk side guards and long side guards are not detachable or swiveling outwards. N° 6107 £466	

Curved back plate (not growable in seat width)			Adaptation holder for
Model 1	Model 2	Model 3	Tarta® back system
BH+2 cm; curve depth: <input type="checkbox"/> 15 mm (...015) <input type="checkbox"/> 30 mm (...030) <input type="checkbox"/> 50 mm (...050) N° 693.. £279 <input type="checkbox"/> Stabilizer bar for a higher stability of the back Recommended with strap system N° 6703	BH+10 cm; curve depth: <input type="checkbox"/> 15 mm (...115) <input type="checkbox"/> 30 mm (...130) <input type="checkbox"/> 50 mm (...150) BH+20 cm; curve depth: <input type="checkbox"/> 15 mm (...215) <input type="checkbox"/> 30 mm (...230) <input type="checkbox"/> 50 mm (...250) N° 693.. £366	BH+5 cm; curve depth: <input type="checkbox"/> 15 mm (...315) <input type="checkbox"/> 30 mm (...330) <input type="checkbox"/> 50 mm (...350) BH+10 cm; curve depth: <input type="checkbox"/> 15 mm (...415) <input type="checkbox"/> 30 mm (...430) <input type="checkbox"/> 50 mm (...450) N° 693.. £366	Adaptation holder incl. SORG-Tarta back tubes <input type="checkbox"/> for back angle adjustable with raster (N° 6109) <input type="checkbox"/> for standard back angle (N° 6237) - Only in combination with stabilizer bar N° 6408 - back height can't be selected when Tarta back system is selected - Not possible with back angle with screwing / curved back plate, back cover / back angle with gas pressure device Not permitted when using the wheelchair as a seat for transportation in the car! Tarta back is NOT included! Order information for Tarta back system and instructions at www.tartadesign.it/en/distributori/ N° 611705 £189
N° 6408 £55	N° 693.. £366	N° 693.. £366	N° 611705 £189

Back extension		Restrictions back extension/Fitting set	Fitting set
for curved back		for solid back	
<input type="checkbox"/> Back extension up to 17.5 cm for curved back plate, retractable, with detachable pad for head; weight reduction in comparison to a head rest approx. 1000 g. Only with curved back plate, not possible with head rest (N° 6860..), not suitable as a head rest for the transport in a passenger vehicle N° 686069 £266		<input type="checkbox"/> one set of clamps, required for mounting a solid back that is manufactured by specialist trade (see picture on the left) N° 692598 £129	
		At Fitting set for solid back (692598): • from SW28 with standard back unit 90° (6237) • from SW30 with adjustable back (6109 / 6231 / 6107)	

To see the latest versions of our order forms, please visit www.sorgrollstuhltechnik.de/download-portal

Measuring the lower leg length (LLL)			
Manufacturer's data	User data	Retailer data	Please indicate both measures on p.1
Our data for the possible lower leg length are: The maximum or rather minimal possible distance between the top edge of the seat to the top edge of the foot plate MEASURED VERTICALLY (90°) .	You are measuring at the user: The distance between the hollow of the knee to the floor (=LLL) , measured at a vertical leg position of 90°	When ordering, please indicate TWO measures: <ul style="list-style-type: none"> • 1. the real LLL of the user AND • 2. the thickness of the cushion used by you 	<p>1. Real lower leg length of the user (LLL):</p> <p>_____ cm</p> <p>2. Cushion thickness (CT)</p> <p>_____ cm</p>

Example		
Our data	Your data	We are assembling
In the order form, we are indicating e.g.: „possible distance from top edge seat to top edge foot plate at internal mounting of leg support = min. 3.5 up to max. 30 cm“.	The real lower leg length of the user amounts e.g.: „LLL = 31 cm“ ; The thickness of the cushion used by you amounts e.g.: „CT = 5 cm“.	Using your data, our technicians are calculating a distance of 26 cm between the top edge of the seat to the top edge of the foot plate. Therefore, the foot plate will be mounted to the position of 26 cm, measured vertically . <i>At a cushion thickness of only 3 cm, our technicians would mount the foot plate to a distance of 28 cm from the top edge of the seat to the top edge of the footplate instead.</i>







Seat cushion (all covers with zippers and changeable)				
	Standard cushion	Anatomical cushion	Cover design	Incontinence cover
<input type="checkbox"/> No seat cushion (please tick if no cushion is required)	Synthetic foam for firm and comfortable seating <input type="checkbox"/> 3 cm (...03) <input type="checkbox"/> 5 cm (...05)	<input type="checkbox"/> Anatomically formed, with slight abduction, changeable cover (Thickness of the front upholstery, depending on cushion size, is 5-6 cm)	in selected cover colour (colour choice and colour code see below -> Choice of cover colour)	<input type="checkbox"/> For standard cushion as configured on the left
<input type="checkbox"/> Seat cushion WITHOUT COVER				
N° 998001 £30	N° 80.. £90	N° 891002 £419		N° 86.. £89
ADDITIONAL COVERS for cushions as configured on the right <input type="checkbox"/> 1 cover (...01) <input type="checkbox"/> 2 cover (...02)	Pressure relief cushion for medium-soft seating <input type="checkbox"/> 3 cm (...03) <input type="checkbox"/> 5 cm (...05)	<input type="checkbox"/> Additional cover for anatomical cushion as configured		<input type="checkbox"/> For anatomical cushion as configured on the left
N° 82.. £75/pcs	N° 81.. £119	N° 891003 £166	N° 80..	N° 891004 £166



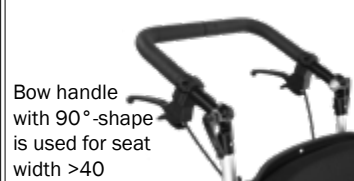



Back cushion (all covers with zippers and changeable)			
	Standard cushion	Anat. back cushion	Cover design
<input type="checkbox"/> No back cushion (please tick if no cushion is required)	<input type="checkbox"/> Standard cushion for curved back plate , 3 cm thick, with zipper, breathable cover (see options below)	Anatomically formed, incl. changeable cover, cavity: <input type="checkbox"/> 3 cm (...04) <input type="checkbox"/> 5 cm (...06) Not possible with adjustable sling system N° 6703..	in selected cover colour (colour choice and colour code see below -> Choice of cover colour)
<input type="checkbox"/> Back cushion WITHOUT COVER	ADDITIONAL COVERS for cushions as configured <input type="checkbox"/> 1 cover (...01) <input type="checkbox"/> 2 covers (...02)	<input type="checkbox"/> ADDITIONAL COVER FOR ANATOMICAL BACK CUSHION as configured	
N° 998501 £30	N° 8517 £139	N° 8911.. CPD 269,- €/pcs	
N° 998501 £30	N° 85.. £75/pcs	N° 891110 £135/pcs	N° 85..



Choice of Trevira cover colour	
Note: Color views may differ from reality depending on the screen view / printout and are only for initial orientation.	
Please choose your colour of the selected covers:	
<input type="checkbox"/> black (30) <input type="checkbox"/> grey (31) <input type="checkbox"/> nightblue (32) <input type="checkbox"/> ultramarine blue (33) <input type="checkbox"/> petrol (34) <input type="checkbox"/> applegreen (35) <input type="checkbox"/> burgundy (36) <input type="checkbox"/> red (37) <input type="checkbox"/> pink (38)	
N° 80.. (seat cushion/anat. cushion) / N° 85.. (back cushion/anat. back cushion) / N° 6703.. (adjustable back cover)	

Side guards and arm rests			
Standard	Clothes guard	Desk side guard	Long side guard
<input type="checkbox"/> Corrugated aluminium, screwed, adjustable in height <i>incl. insulation protection pads</i>	<input type="checkbox"/> Corrugated aluminium, screwed, adjustable in height, with synthetic clothes guard <i>incl. insulation protection pads</i>	<input type="checkbox"/> for driving under tables etc., foldable backwards, inward swivelling and detachable, aluminium in combination with gas pressure spring back angle (6107), screwed side guards	<input type="checkbox"/> Foldable backwards, swingable backwards and detachable, aluminium in combination with gas pressure spring back angle (6107), screwed side guards
N° 4525 £ 0/P	N° 5024 £139/P	N° 4610 £149/P	N° 4611 £149/P
Arm rest	Clothes guard	Raster arm rest	Long arm rest
<input type="checkbox"/> with pad, 24 cm long, screwed, adjustable in height. Suitable for all side guards (except for long side guard)	<input type="checkbox"/> Clothes guard, black, for desk side guard, screwed Only for N° 4610, not with arm rests	<input type="checkbox"/> with pad, 24 cm long, with raster adjustable in height. Only suitable for desk side guard and long side guard	<input type="checkbox"/> with pad, 37 cm long, screwed, adjustable in height. Only suitable for long side guard N° 4611
N° 452600 £180/P	N° 461001 £110/P	N° 452506 £180/P	N° 452507 £180/P

To see the latest versions of our order forms, please visit www.sorgrollstuhltechnik.de/download-portal

Push handles				
Standard		Extendable		Bow handle
Short handle (5 cm)	Long handle (11 cm)	Short handle (5 cm)	Long handle (11 cm)	 <p>Bow handle with 90°-shape is used for seat width >40</p>  <p>Bow handle with trapeze shape is used for seat width <40</p>
				

Brakes			
Knee lever brake	Bowden cable brake	Roll-back blocking	Single-hand brake
   <p>standard lockable Pull to Lock</p>			

Brake lever extension		
Cover	Ball knob	Golf ball knob
		

Leg support with foot plate for BSA-frame Standard and XL height (adjustable in height, depth and angle)				
Model 1 undivided	Model 2 undivided	Model 3 divided	Model 4 divided	Model 6 swivelling
<input type="checkbox"/> Internal mounting , undivided foot rest, hinged side-wards Distance 'Seat/Foot rest' measured WITHOUT SEAT CUSHION : • Standard height 5.5-34 cm • XL height 5.5-38 cm	<input type="checkbox"/> External mounting , undivided foot rest, hinged side-wards Distance 'Seat/Foot rest' measured WITHOUT SEAT CUSHION : • Standard height 29-47 cm • XL height 33-51 cm	<input type="checkbox"/> Internal mounting , divided foot rest, hinged side-wards Distance 'Seat/Foot rest' measured WITHOUT SEAT CUSHION : • Standard height 5.5-34 cm • XL height 5.5-38 cm	<input type="checkbox"/> External mounting , divided foot rest, hinged side-wards Distance 'Seat/Foot rest' measured WITHOUT SEAT CUSHION : • Standard height 29-47 cm • XL height 33-51 cm	<input type="checkbox"/> with divided foot plates, swivelling and detachable with physiological pivotal point, hinged upwards from 93° to 180°, swiveling outwards Only possible with abducted frame Distance 'Seat/Foot rest' measured WITHOUT SEAT CUSHION : • Standard height 21-46 cm • XL height 25-50 cm
N° 403601 £ 0	N° 403610 £ 0	N° 403602 £156	N° 403612 £156	N° 403705 £298

Calf rest	Leg support options	
	Heel cups	Locking mechanism
for the leg support N° 403705 Mounting: <input type="checkbox"/> right <input type="checkbox"/> left <input type="checkbox"/> pair (2 pcs.) Possible distance top edge seat to top edge footplate: from 20cm	for self-assembly, black <input type="checkbox"/> Size 1 (..01) 7 x 11.5 cm <input type="checkbox"/> Size 2 (..02) 9 x 12.5 cm <input type="checkbox"/> Size 3 (..03) 10 x 15.5 cm	<input type="checkbox"/> Locking mechanism for leg support models with undivided foot rest
N° 403006 £129/pcs	N° 4020.. £54/P	N° 403910 £69



Push handles		
Standard push handles	Extendable push handles	Bow handle
<input type="checkbox"/> Long handle (see on pictures) firm, 4 cm above back height N° 623701 £ 0	Shape Straight <input type="checkbox"/> 15 cm (..01) <input type="checkbox"/> 25 cm (..02) Cranked <input type="checkbox"/> 15 cm (..05) <input type="checkbox"/> 25 cm (..06)	<input type="checkbox"/> extendable by 20 cm, 307° adjustable in angle by steel joint
<input type="checkbox"/> Short handle (see on pictures) 4 cm above back height Not in combination with drum brake! N° 623703 £26/P	<input type="checkbox"/> Extendable push handles with long handle (cf. on the left) N° 65.. £235/P	<input type="checkbox"/> Extendable with short handle (cf. on the left) Not in combination with drum brake! N° 65..+ 623702 £259/P
		N° 6532 £369

Brakes				
Knee lever brake	Bowden cable brake	Drum brake	Single-hand brake	Roll-back blocking
<input type="checkbox"/> Standard N° 3525 £ 0	<input type="checkbox"/> Bowden cable brake, integrated in activity side guards Only with activity side guards N° 5024	<input type="checkbox"/> for standard-, profile or lightweight wheels (N° 21..30/31/81), incl. brake lever for attendant	Knee lever brake with single hand control Mounting <input type="checkbox"/> left (..01) <input type="checkbox"/> right (..02)	<input type="checkbox"/> Averts automatically the risk of rolling backwards without affecting forward movements Recommended for a user weight up to max. 90 kg A knee lever brake function is included with the rollback blocking! It is not possible to select an additional knee lever brake.
<input type="checkbox"/> lockable in activated or deactivated position N° 3513 £165/P				
<input type="checkbox"/> Pull to lock N° 3529 £58/P	N° 3531 £200/P	N° 220036 £289	N° 3509.. £279	N° 3526 £300/P

Brake lever extension		Wheel size and wheel camber		
Straight 6 cm	Cranked 12 cm	Wheel size	Wheel camber	
Straight, 6 cm <input type="checkbox"/> with top cover N° 3510 £50/P	Cranked, 12 cm <input type="checkbox"/> with top cover N° 3515 £54/P	<input type="checkbox"/> 22" <input type="checkbox"/> 24" N° 212601 £169	Wheel camber (Standard wheels) <input type="checkbox"/> 0° <input type="checkbox"/> 2° <input type="checkbox"/> 5° <input type="checkbox"/> 8°	Wheel camber (drum brake) <input type="checkbox"/> 2° (not recommended) <input type="checkbox"/> 5° <input type="checkbox"/> 8°
Straight, 6 cm <input type="checkbox"/> with ball knob <input type="checkbox"/> with golf ball knob N° 3512 £58/P	Cranked, 12 cm <input type="checkbox"/> with ball knob <input type="checkbox"/> with golf ball knob N° 3516 £68/P		N° 212601 £ 0	N° 212601 £ 0

Mounting of handrims Please indicate the desired kind of mounting!			
Standard tight	Standard wide	High tight	High wide

Handrim options			
Silicone cover	Ergo rubber inlay	Maxgrepp handrim	ergonomic handrim

Wheels				
Standard wheel	Profile wheel	Lightweight wheel	Double handrim	Distance double handrim





To see the latest versions of our order forms, please visit www.sorgrollstuhltechnik.de/download-portal

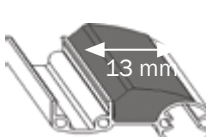
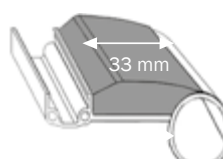

Wheels				
Standard wheel	Profile wheel	Lightweight wheel with standard hub	Lightweight wheel with drum brake hub	Double handrim
<input type="checkbox"/> All-round wheel Additional weight of approx. 900g/wheel compared to lightweight wheels	<input type="checkbox"/> Unity of handrim and rim, reduces the risk of finger injuries Additional weight of approx. 800g/wheel compared to lightweight wheels	<input type="checkbox"/> with standard hub Very lightweight, incl. aluminium handrim Weight reduction of approx. 900g/pair compared to standard wheels The standard hub is incompatible with the drum brake (N° 220036!) No solid tyres possible for 26" wheels.	<input type="checkbox"/> with drum brake hub , incl. aluminium handrim black Only in combination with drum brake (N° 220036) (mind Additional charge) Weight reduction of up to 1.1 kg/pair compared to standard drum brake wheels Package price for lightweight wheels incl. drum brakes and brake lever for the attendant 420,- €/pair Not possible with wheel size 26"	with standard hub and double handrim, Only up to 5° camber Mounting <input type="checkbox"/> left <input type="checkbox"/> right N° 2614 £949 with drum brake hub and double handrim Mounting <input type="checkbox"/> left <input type="checkbox"/> right N° 2615 £1050 <input type="checkbox"/> Handrim for opposite site N° 261435 149,-€ Distance of handrims¹ <input type="checkbox"/> standard 18mm (...11) <input type="checkbox"/> tight 9mm (...12)
N° 21..30 £ 0	N° 21..31 £ 0	N° 21..76 £139/P	N° 21..81 £100/P	N° 26.. £ 0

Tyres		
Standard	Standard	Performance
Pneumatic: <input type="checkbox"/> Schwalbe <i>Right Run</i> 1" (...13) <input type="checkbox"/> Standard tyres 1 3/8" (...21)	Solid tyres: <input type="checkbox"/> Standard tyres 1" (...11) <input type="checkbox"/> Standard tyres 1 3/8" (...21) 1 3/8" tyres not for lightweight wheels and 26" wheels	Pneumatic: <input type="checkbox"/> Schwalbe <i>Marathon Plus</i> , black, pneumatic flat free tyres 1" Only for 22" and 24" wheels
N° 20.. £ 0	N° 23.. £ 0	N° 20..12 £65/P

Handrims / Handrim options			
Mounting and material	Mounting on lightweight wheels	Ergonomic handrim	Design handrims
<input type="checkbox"/> Standard / tight <input type="checkbox"/> Standard / wide <input type="checkbox"/> High / tight <input type="checkbox"/> High / wide Material: <input type="checkbox"/> Stainless steel (30..01) <input type="checkbox"/> Alu, silver anodized (30..75)	<input type="checkbox"/> Standard / tight <input type="checkbox"/> Standard / wide <input type="checkbox"/> High / tight <input type="checkbox"/> High / wide Material: Alu Mounting high is not possible with lightweight wheels with drum brakes.	<input type="checkbox"/> handrim with ergonomic handrim profile, black anodized with built-in rubber grip only for 24" and 26" wheels	<input type="checkbox"/> Aluminium handrims coated in frame colour
N° 30.. £ 0	N° 30..75 £ 0	N° 3424.. £369	N° 303000 £48/P



Handrim options			
Silicone <small>Not for double handrim 20"</small>	PVC	Ergo rubber inlay	Maxgrepp handrim
Detachable silicone cover, black (soft surface) <input type="checkbox"/> for standard wheel (22-24) <input type="checkbox"/> for profile wheel (...02) <input type="checkbox"/> for lightweight wheel (...05)	<input type="checkbox"/> Handrim coated with black PVC, (<i>Tetra Grip</i>) Only for standard and lightweight wheels	<input type="checkbox"/> Rubber inlay, 13 mm wide, Only for profile wheels	<input type="checkbox"/> Allows pushing with the heel of hand (soft surface), only for standard and lightweight wheels
N° 32.. £136	N° 33.. £320		
for double handrim	for double handrim		
Detachable black silicone cover <input type="checkbox"/> for inner handrim <input type="checkbox"/> for outer handrim <input type="checkbox"/> for opposite handrim Not in combination with double handrim distance tight N° 2612	<input type="checkbox"/> Handrim coated with black PVC, (<i>Tetra Grip</i>) Not for profile wheels N° 262402 £310 <input type="checkbox"/> PVC coating, black, for opposite handrim		
N° 3205 £75/pcs	N° 262401 £179	N° 32..01 £180	N° 34.. £395

Caster wheels				
Standard PU	Standard solid rubber	Standard pneumatic	Design PU	Design solid rubber
				

Steering options	
Single-hand steering	Locking mechanism
	

Spoke cover		Design spoke covers / Design curved back		
Transparent	Design spoke covers		Design curved back	
<input type="checkbox"/> transparent (..00)	<input type="checkbox"/> www.speichen-schutz.de	<input type="checkbox"/> www.wheelchairgadgets.com	<input type="checkbox"/> Optional: child's name on spoke cover. Name: _____ _____ Only for Design Decor	<input type="checkbox"/> Foil for curved back plate with the same design as the specified spoke cover Only with curved back plate
N° 25.. £150	N° 25..26 TBD	N° 25..27 TBD		N° 2527 £110

Caster wheels				
Standard PU	Standard solid rubber	Standard pneumatic	Design PU	Design solid rubber
Polyurethane: <input type="checkbox"/> 4" (2812) <input type="checkbox"/> 5" (2805) <input type="checkbox"/> 6" (2803)	Solid rubber: <input type="checkbox"/> 4" (2804) <input type="checkbox"/> 5" (2809) <input type="checkbox"/> 5.5" (2806) <input type="checkbox"/> 6" (2811) <input type="checkbox"/> 7" (2813)	Pneumatic, grey: <input type="checkbox"/> 6" (2808) <input type="checkbox"/> 7" (2807)	Polyurethane, transparent, with LEDs: <input type="checkbox"/> 4" (2820) <input type="checkbox"/> 5" (2834)	Solid rubber black, with alu rim <input type="checkbox"/> 4" (2835) <input type="checkbox"/> 5" (2836) <input type="checkbox"/> 6" (2838)
£ 0	£ 0	£ 0	£ 0	£ 0

Caster forks				
Standard aluminium	Design aluminium	Hemi-Adapter	Quick-release axle	Additional set
<input type="checkbox"/> Alu fork, black anodized 	<input type="checkbox"/> Alu fork, coated in chosen frame colour  (Colour example)	to reduce the front seat height around <input type="checkbox"/> 25 mm (..40) around <input type="checkbox"/> 40 mm (..41) See table p. 16	<input type="checkbox"/> Alu caster fork with quick-release axle Not possible with Outdoor Front End N° 599520, N° 2851 and N° 2850	<input type="checkbox"/> Additional set of changeable caster wheels (incl. caster and fork); Caster size: _____ " Only with quick release axle N° 2721 Not possible with N° 599520, N° 2851, N° 2850
N° 2826 £ 0	N° 2829 £42/P	N° 2805.. £129/P	N° 2721 £162/P	N° 2830 £239 /P

Steering options		
Single-hand steering	Track fixation	Locking
Mounting <input type="checkbox"/> left (..51) <input type="checkbox"/> right (..52) Not possible with bowden cable brake N° 3531	<input type="checkbox"/> Caster wheel track fixation (straight) Not with N° 2721, N° 2830	<input type="checkbox"/> Locking mechanism for track fixation Not with N° 2721, N° 2830
N° 26.. £439	N° 2851 £142	N° 2850 £180

Frame options				
Outdoor Front End	Anti tipper	Water bottle	Caddy	Sun shade

Head rests <small>Measures in mm</small>		
Model 1	Model 3	Model 4
shell-shaped	curved - small	curved - large

Belt systems			
2-point pelvic belt	4-point pelvic belt	Chest-shoulder belt	Protection cap
with plastic fastener 	with metal fastener 		only for metal fastener

To see the latest versions of our order forms, please visit www.sorgrollstuhltechnik.de/download-portal

Frame options				
Anti-tipper	Outdoor Front End	Splash guard	Sun shade	
Swingaway installation Mounting <input type="checkbox"/> right <input type="checkbox"/> left <input type="checkbox"/> pair	<input type="checkbox"/> Outdoor Front End, adjustable in width and length, facilitates significantly active and passive driving on soft or rough surfaces, incl. mounting aid	<input type="checkbox"/> Splash guard for Outdoor Front End, made of plastic 	<input type="checkbox"/> Size 1 (only up to SW38) variably adjustable sun shade, in black Usable height (from the top edge of the seat plate/seat cover to the apex) = selected back height + 40 cm Example: BH 30 + 40 cm = 70 cm	<input type="checkbox"/> Size 2 (just from SW40) variably adjustable sun shade, in black Usable height (from the top edge of the seat plate/seat cover to the apex) = selected back height + 55 cm Example: BH 30 + 55 cm = 85 cm
N° 7215 £119/pcs	N° 599520 £399	N° 59951212 £79	N° 910301 £220	N° 910302 £260

Frame options				
Water bottle	Step tube	Crutch holder	Baggage holders	Wheel base extension
<input type="checkbox"/> Water bottle 750 ml, light PET-bottle, incl. holder Stabilizer bar required!	Mounting <input type="checkbox"/> right <input type="checkbox"/> left <input type="checkbox"/> pair	Mounting <input type="checkbox"/> left <input type="checkbox"/> right <input type="checkbox"/> pair	<input type="checkbox"/> Transport aid, aluminium, mounted on leg support	<input type="checkbox"/> Wheel base extension approx. 10 cm to the back Only in axle plate position 1 (very passive)
N° 790101 £35	N° 7400 £70/pcs	N° 7101 £37/pcs	N° 910110 £90	N° 7601 £230

Positioning aids Here you will find a small selection to mark. You will find more positioning aids, corresponding mounting possibilities and further equipment in the separate order form „Positioning aids“			
Separate order form	2-point pelvic belt	4-point pelvic belt	Head rests with holder
<p>PLEASE REGARD On the separate order form „Positioning aids“ you will find many different products for positioning, e.g.:</p> <ul style="list-style-type: none"> • belts, • fixations and corresponding connections, • abduction wedges, • side truss pads, • head rests, • and more...  <p>Order form „Positioning aids“, available in download area.</p> <p>On the order form refer to this new wheelchair order/enquiry.</p>	<input type="checkbox"/> with plastic fastener £119 <input type="checkbox"/> with metal fastener £139 The size is determined by us according to the chosen wheelchair measurements.	<input type="checkbox"/> with plastic fastener £149 <input type="checkbox"/> with metal fastener £179 The size is determined by us according to the chosen wheelchair measurements.	<p>All head rests including connection and stabilizer bar</p> <input type="checkbox"/> Model 1, (...21) shell-shaped small <input type="checkbox"/> Model 3, (...23) curved small <input type="checkbox"/> Model 4, (...24) curved large
	N° 780502	N° 780504	
	Chest-shoulder belt <input type="checkbox"/> Chest-shoulder belt without zipper	Protection cap <input type="checkbox"/> protection cap for metal fastener Makes independent opening for the patient difficult.	
	N° 7810 £179	N° 78050210 £15	

To see the latest versions of our order forms, please visit www.sorgrollstuhltechnik.de/download-portal

Lateral support (swing-away)	
<p>1. Connection to back 2. Bottom to swing away 3. Adjustable joint 4. Support for pads 5. Pads</p>	
<p>Measures for pads, size 1 10 x 7 cm 10 x 9 cm</p>	<p>Measures for pads, size 2 15 x 10 cm 18 x 13 cm</p>

Therapy tables		
Transparent	Beech wood	Design (example)

Lateral support			
Holder	Pad		Extensions
Holder adjustable, size 1, incl. linkage, without pad <input type="checkbox"/> left side (..01) <input type="checkbox"/> right side (..02) N° 685901.. CPD 190,- €/pcs	for truss pad size 1 Attention: Cushions for size 1 can only be mounted on truss pads size 1. 1 pcs. 2 pcs. <input type="checkbox"/> <input type="checkbox"/> 10x7cm (..04) <input type="checkbox"/> <input type="checkbox"/> 10x9 cm (..05)	for truss pad size 2 Attention: Cushions for size 2 can only be mounted on truss pads size 2. 1 pcs. 2 pcs. <input type="checkbox"/> <input type="checkbox"/> 15 x 10 cm (..04) <input type="checkbox"/> <input type="checkbox"/> 18 x 13 cm (..05)	Additional extension of joint for size 1 (3,8 cm) (..0103) 1 St. 2 St. <input type="checkbox"/> <input type="checkbox"/> for size 2 (5,5 cm) (..0203) 1 pos. 2 pos. <input type="checkbox"/> <input type="checkbox"/>
N° 685902.. £179/pcs	N° 685901.. £55/pcs	N° 685902.. £55/pcs	N° 6859.. £60/pcs

Therapy tables			
Mounting	Transparent	Beech wood (varnished)	Design
Adjustable in height and distance, plugged under arm rests on both sides Arm pads required!	<input type="checkbox"/> Size 1 45 x 36 cm N° ..10 £289	<input type="checkbox"/> Size 1, 50 x 40 cm N° ..13 £310	<input type="checkbox"/> Number of design for plexiglas therapy table according to wheelchairgadgets.com:
	<input type="checkbox"/> Size 2 59 x 45 cm N° ..11 £300	<input type="checkbox"/> Size 2, 60 x 50 cm	
	<input type="checkbox"/> Size 3 70 x 50 cm		
	N° 9207.. £325	N° ..14 £349	
N° 92099 £90			

Transport brackets	
Compatibility with electrical drive systems or Outdoor-Front-End	Transport brackets
Please tick appropriate box if number N° 585069.. was selected (Without ticking an appropriate box, delivery will be without compatibility to additional systems): <input type="checkbox"/> Outdoor-Front-End (restraint brackets at the front) <input type="checkbox"/> Neither Restraint brackets must be replaced by a subsequent fitting of an Outdoor-Front-End to the wheelchair	Transport brackets (4 pieces) for transportation in a handicapped accessible passenger car  <input type="checkbox"/> Standard frame height (..20) <input type="checkbox"/> XL frame height (..21)
	N° 585069.. £329

Electric drives and systems		
Recommendations	Provider	Information
1. For all possible drives and systems we recommend casters of 6" or higher. 2. Please regard the respective mounting possibilities and specifications given on the homepages indicated on the right.	for example www.aat-online.de or www.alber.de	Restrictions and adjustments to the installation and the final configuration of the wheelchair are the responsibility of the providers of the additional systems.

Configurations and Adjustments (Back to „Measures“)

Axle plate bore holes alter the seat height by ±2 cm each.

All specifications measured WITHOUT cushions!

The mounting of a short or a long caster fork depends on the desired measures indicated above.

Lower leg length: The maximal LLL possible results from the formula „chosen seat height front minus steering wheel diameter“. Larger LLL are possible dependent on the chosen seat depth, the size and position of the rear wheels and the depth adjustment of the foot rest. The setting range for the „internal mounting“ of the leg support is LLL 0-32 cm, for external mounting LLL 30-49 cm.

Please note: When using the Hemi-Adapter (N ° 280540/41) for the caster connection, the values for the front seat height of the table below are reduced by 2.5 and 4 cm, respectively. **Please also note the possible rear seat height.**

All specifications ±5 %

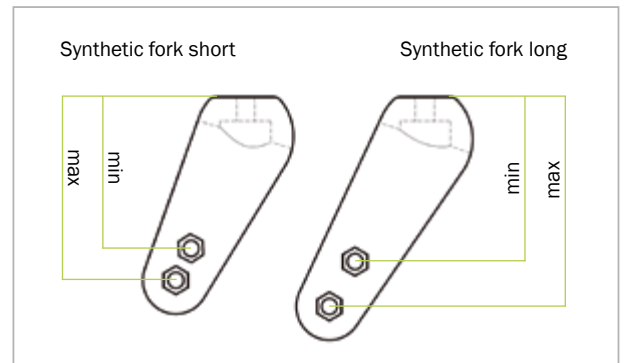
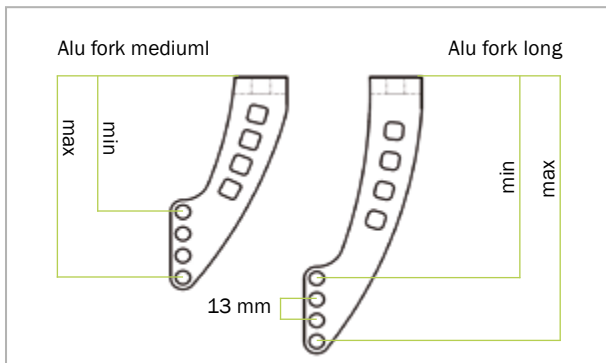

Seat height front with aluminium caster fork (AF) (without seat inclination)			for XL-frame	
Caster/caster fork	min.	max.	min.	max.
4" (ø 10 cm) AF/ m	39,5	43,5	43,5	47,5
4" (ø 10 cm) AF/ l	43,5	47,5	47,5	51,5
5" (ø 12,5 cm) AF/ m	41	45	45	49
5" (ø 12,5 cm) AF/ l	45	49	49	53
5,5" (ø 14 cm) AF/ m	43	45,5	47	49,5
5,5" (ø 14 cm) AF/ l	45,5	49,5	49,5	53,5
6" (ø 15 cm) AF/ m	43,5	46	47,5	50
6" (ø 15 cm) AF/ l	46	50	50	54
7" (ø 17,5 cm) AF/ m	46	47,5	50	51,5
7" (ø 17,5 cm) AG/ l	47,5	51,5	51,5	55,5

Seat height front with synthetic caster fork (SF) (without seat inclination)			for XL-frame	
Caster/caster fork	min.	max.	min.	max.
4" (ø 10 cm) SF	39,5	41	43,5	45
4" (ø 10 cm) SF/ l	40,5	42,5	44,5	46,5
5" (ø 12,5 cm) SF	42,5	42,5	46,5	46,5
5" (ø 12,5 cm) SF/ l	43,5	45,5	47,5	49,5
5,5" (ø 14 cm) SF	43	43	47	47
5,5" (ø 14 cm) SF/ l	42,5	44,5	46,5	48,5
6" (ø 15 cm) SF	43,5	43,5	47,5	47,5
6" (ø 15 cm) SF/ l	45	45	49,5	49
7" (ø 17,5 cm) SF/ l	46,5	46,5	50,5	50,5

Abbreviations:

SF = synthetic fork, AF = alu fork

l = long, m = medium

Seat height back (without seat inclination)			for XL-frame	
Rear wheel	min.	max.	min.	max.
22" x 1"	34	46		
22" x 1 3/8"	35	47		
24" x 1"	36,5	48,5	40,5	52,5
24" x 1 3/8"	37,5	49,5	41,5	53,5
26" x 1"	-	-	43	55
26" x 1 3/8"	-	-	44	56

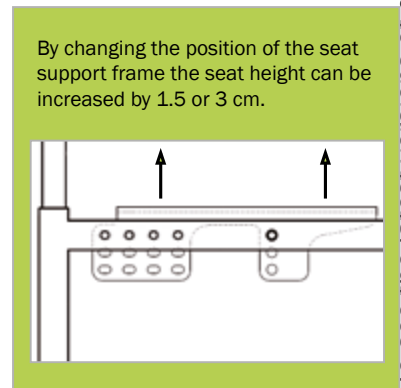
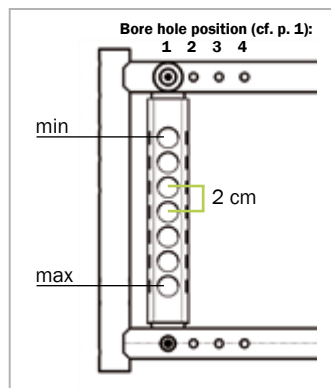

To see the latest versions of our order forms, please visit www.sorgrollstuhltechnik.de/download-portal

Configurations and Adjustments

All specifications $\pm 5\%$

Wheel combination for seat depths 34-36					
Caster wheel/ Rear wheel	4" possible with	5" possible with	5.5" possible with	6" possible with	7" possible with
22" x 1"	AP 1,2,3	AP 1,2,3	AP 1,2,3	AP 1,2,3	AP 1,2
22" x 1 3/8"	AP 1,2,3	AP 1,2,3	AP 1,2	AP 1,2	AP 1
24" x 1"	AP 1,2,3	AP 1,2,3	AP 1,2,3	AP 1,2	AP 1
24" x 1 3/8"	AP 1,2,3	AP 1,2,3	AP 1,2	AP 1	AP 1
Wheel combination for seat depths 38-44					
Caster wheel/ Rear wheel	4" possible with	5" possible with	5.5" possible with	6" possible with	7" possible with
22" x 1"	AP 1,2,3	AP 1,2,3	AP 1,2,3	AP 1,2,3	AP 1,2
22" x 1 3/8"	AP 1,2,3	AP 1,2,3	AP 1,2,3	AP 1,2,3	AP 1,2
24" x 1"	AP 1,2,3	AP 1,2,3	AP 1,2,3	AP 1,2,3	AP 1,2
24" x 1 3/8"	AP 1,2,3	AP 1,2,3	AP 1,2,3	AP 1,2,3	AP 1
No restrictions for wheel combination at seat depths 46-50					
Vector BSA with XL-frame					
Wheel combination for XL seat depths 44-50					
Caster wheel/ Rear wheel	4" possible with	5" possible with	5.5" possible with	6" possible with	7" possible with
24" x 1"	AP 1,2,3,4	AP 1,2,3,4	AP 1,2,3,4	AP 1,2,3,4	AP 1,2,3,4
24" x 1 3/8"	AP 1,2,3,4	AP 1,2,3,4	AP 1,2,3,4	AP 1,2,3,4	AP 1,2,3,4
26" x 1"	AP 1,2,3,4	AP 1,2,3,4	AP 1,2,3,4	AP 1,2,3,4	AP 1,2,3,4
26" x 1 3/8"	AP 1,2,3,4	AP 1,2,3,4	AP 1,2,3,4	AP 1,2,3,4	AP 1,2,3

AP = Axle plate position

Note:

Seat depth	Frame	Difference seat height front - seat height back (with seat inclination of 5°)
34 - 36 cm	Size 1	3 cm
38 - 44 cm	Size 2	3.5 cm
46 - 50 cm	Size 3	4 cm

piece - pcs	seat width - SW	lower leg length - LLL
pair - P	seat depth - SD	customized product discount - CPD
Trade discount - TD	back height - BH	Additional charge - AC
configuration - cf.		

Terms and conditions

1. Preface and Scope

(1) Our terms and conditions apply exclusively. Any deviating, opposing, or complementing terms and conditions on the part of the business partner do not form integral part of contract unless explicitly approved of by us. There are no exceptions to the consent requirement, which also applies in cases where we conduct deliveries without restrictions while aware of the business partner's terms and conditions.

(2) Agreements made in the individual case with the purchaser (including side-agreements, supplements, and alterations) always take priority over these terms and conditions. A contract or our confirmation - both in written form - are authoritative for the content of such arrangements.

(3) Any legally relevant declarations and notifications the purchaser submits to us after conclusion of the contract (e.g. setting of deadlines, notice of defects, declarations of rescission or abatement) require the written form to be valid.

(4) Any information on the application of legal regulations serves the mere purpose of clarification. All regulations are legally binding without any such clarifications unless explicitly altered or excluded in these terms and conditions.

2. Prices

All prices are ex works, excluding insurance and packaging. The prices are net prices; the value-added tax is stated and charged separately according to the legally binding rate at the time of invoicing. The prices valid on the day of delivery are binding unless explicitly arranged otherwise.

3. Conclusion of Contract

SORG's offers are *invitatio ad offerendum* (invitations to treat). Ordering goods counts as an obligatory offer of contract on the part of the purchaser. Unless the order suggests otherwise, we have the right to accept this contract offer within two weeks time after reception. The acceptance of an offer of contract is effected by the confirmation of the order.

4. Terms of Payment

(1) Provided that no other agreements exist, payment is to be made by paying in advance - 50% at placing of order, 50% pre-delivery of goods. The purchaser bears any costs arising from transactions or discounting.

(2) If a 30-day payment deadline is exceeded, a delay rate of 9% on top of the respective base rate of the European Central Bank falls due without the need for prior notices. Beyond that, the purchaser is charged 3,- € for any reminder sent. We reserve the right to make use of the commercial due rate according to § 353 HGB. A higher damage for delay may be enforced via a suitable verification.

5. Offers and Validity

All current price lists are generally valid until December 31 of the respective year, or until new price lists are published. The latest version of the price list will always be provided on our homepage. Offers older than 3 months at that point expire and must be replaced with new offers and prices.

6. Time of Delivery and Delay

We state the terms of delivery when accepting the order. The delivery date is non-binding and has mere guideline value - especially with regard to customised products. The terms for delay in delivery are defined by legal regulations. In any case, a writing notice issued by the purchaser is necessary for them to take effect.

7. Force Majeure (Act of God)

(1) SORG is not to be held responsible for the following delays of delivery. This also applies if these causes occur with respect to legal representatives, auxiliary persons, or deliverers of SORG: Circumstances of force majeure as well as other extraordinary events that are unpredictable and unavoidable for, and not caused by, SORG, and that only occur after ordering or reserving, and that SORG could not have known about. Moreover, this applies in case of strikes, fire, floods, labour disputes, business disruptions, altered magisterial approbation and legal situation, and magisterial orders which are not due to operational risks.

(2) In the cases of paragraph 1, SORG is eligible to delay delivery/performance for the time of hindrance as well as an appropriate start-up time. If SORG thus causes unacceptable complications for the purchaser, both SORG and the purchaser are eligible to withdraw from the contract. Circumstances that only lead to a temporal and hence acceptable delay of delivery and performance are excluded from this right. The legal rights of the client remain unaffected.

8. Dispatch

We generally dispatch uncovered by insurance and at the recipient's risk. We transfer the risk of accidental loss or deterioration of the goods as well as delay on to the client at the moment of passing the goods on to the forwarder, bearer, or any other person/institute responsible for delivery. SORG will make any effort to respect the client's wishes in terms of path and kind of delivery. Any costs caused by this (including agreed carriage free delivery) are to be covered by the client.

In the case of carriage free delivery conducted by SORG, the recipient is required to put forward any carriage costs for a refund. If the client wishes the dispatch to be delayed, any risk of loss or deterioration of the goods is carried by the recipient from the first day of readiness for dispatch. The goods dispatched are only insured upon special demand and at the cost of the recipient.

9. Damage through Delivery: *Angelieferte Gegenstände sind, auch wenn sie unwesentliche Mängel* Upon delivery, the goods need to be checked for obvious damage in the presence of the bearer. Any damage is to be documented in a written form and co-signed by the bearer. This protocol is to be forwarded to us immediately. Delayed reclamations, or reclamations not signed by the bearer, cannot be taken into account.

10. Warranted Features, Receipt, and Technical Alterations

Delivered objects, even with minor damage, are to be accepted by the client, even if §433 paragraph 1 BGB is not fulfilled. Partial deliveries are permissible. Features only count as warranted if explicitly designated as such. A warranty of condition can only be asserted explicitly and in a written form. SORG reserves the right for technical alterations, especially for solutions of equal or higher value.

11. Warranty for Defects

(1) SORG warrants for any defects of delivered new goods for 12 months as long as the purchaser is not the user (§§ 474, 13 BGB). Should the purchaser be the user then the warranty period is two years for new goods, for used goods 12 months. Should the purchaser also be an entrepreneur, then the liability for used items is void, as long as there is no claim for compensation according to N° 12.

(2) The purchaser's claim for defects presuppose that he has attended his obligation to give notice of defects on the legal grounds for his reasons of inquiry (§§ 377, 381 HGB). If defects are found during the inspection or at a later point, we are to be notified in writing without delay. The notice counts as not delayed if issued within two weeks. Posting the notice on time suffices for the keeping of the term. Independently from this obligation to inspect and give notice, the purchaser

is to report obvious defects (including wrong and short delivery) within two weeks upon delivery (again, posting the notice on time suffices). If the purchaser misses the proper inspection and/or notice of defects, we do not warrant for the reported defects. If the delivered good is defected, we may choose to conduct supplementary performance either by repairing the defect (subsequent improvement) or by delivering flawless goods (compensation delivery). Our right to refuse the chosen method of supplementary performance on the respective legal grounds remains untouched.

(3) Our liability for defects expires when alteration or maintenance works are done by the client or a third-person-party without our prior written permission. Consequences of excessive strain, negligent or incorrect handling, and violent damage are excluded from the warranty for defects.

12. Further Liability

(1) With respect to compensation - regardless of the legal cause - SORG is only liable in case of malice and act of gross negligence. In case of slight negligence, SORG is only liable for damage of life, body, health, and for damage caused by the negligence of an essential contractual obligation (an obligation whose fulfilment make the proper realisation of the contract possible in the first place and in whose fulfilment the contract partner regularly trusts and can trust). In this case, however, our liability does not exceed the covering of predictable, typically occurring damage.

(2) A free right to termination on the part of the purchaser (acc. to § 651, 649 BGB in particular) is precluded. Otherwise, the usual prerequisites and legal consequences apply.

13. Costs of Supplementary Performance

Costs of supplementary performance cannot be charged on SORG's account.

14. Voluntary Withdrawal of Goods

SORG is not obliged to take back any delivered end products or parts thereof. If SORG voluntarily decides otherwise in individual cases (especially for therapeutically altered requirements or deaths), SORG refunds a maximum of 75% of the delivery costs for unused parts whose delivery does not date back more than three months. There is no legal obligation concerning withdrawal in this respect. Deliveries which date back more than three months as well as sewed parts and customised products are not returnable. A copy of the delivery note or the bill serves as proof of age of delivery.

15. Reservation of Ownership

Goods delivered by SORG remain the property of SORG until any obligations from the parties' business contract on the part of the purchaser have been redeemed. This also applies if SORG has adapted individual or all claims into a running account which has been balanced and acknowledged. The purchaser has the right to dispose of the goods in the proper course of business. The purchaser hereby yields all claims to SORG which arise from the resale against the purchaser or third parties. The purchaser is authorised to withdraw these claims even upon conveyance. SORG's right to withdraw the claims remains untouched. However, SORG is obliged not to withdraw the claims as long as the purchaser complies with his duty of payment and any other duties. SORG has the right to demand that the purchaser makes known the yielded claims and their debtors, that he provides all information necessary for conveyance, and that he hands in all associated documents. As long and insofar the reservation of ownership is intact, the purchaser must not transfer any goods for securing or bailment without SORG's permission. The purchaser may process or alter the goods for the benefit of SORG exclusively. If processed with other goods which do not belong to SORG, SORG obtains co-ownership of these new goods in relation to the invoice value to the cost price of the other processed goods. If a third party interferes with SORG's ownership, the purchaser is to notify SORG immediately. The purchaser must not make any agreements with other purchasers which may exclude or limit SORG's rights. In particular, the purchaser must not make any agreements which destroy or limit the advance assignments to SORG. If the estimated value of the existing guarantees exceeds the claims to be ensured by more than 20%, SORG is insofar obliged to release by request of the purchaser.

16. Copyright Protection

If SORG conveys any images, drawings, indications of weight or measurements, technical documentations, or other product descriptions and documents (including electronic ones), the respective indications only apply if explicitly stated that they do. SORG reserves ownership and copyright of all these documents. They may only be made available to third parties upon SORG's explicit permission.

17. Place of Fulfilment, Place of Jurisdiction, and Severability Clause

(1) The law of the Federal Republic of Germany applies for these Terms and Conditions and all legal relations between us and our business partners. All international and supranational (contractual) legal systems, the UN Convention on Contracts for the International Sale of Goods in particular, are hereby excluded. Prerequisites and effects of the reservation of ownership acc. to no. 15 are subject to the right of the respective storage location of the good if the choice of law made in favour of the German law is illegitimate or ineffective. The only place of jurisdiction (also on an international basis) for any disputes arising directly or indirectly from the contractual relationship is, according to German Commercial Code, our office in Oberhausen-Rheinhausen, Germany. However, we also have the right to file a suit concerning the general jurisdiction of the purchaser.

(2) If any clause in these Terms of Conditions should turn out to be ineffective, this does not affect the effectiveness of all other clauses.

Technical alterations and misprints reserved. As of: January 2017

SORG Rollstuhltechnik GmbH + Co. KG
Benzstr. 3-5, 68794 Oberhausen-Rheinhausen / Germany
Phone +49 7254 / 9279-0
Fax +49 7254 / 9279-10
info@sorgrollstuhltechnik.de, www.sorgrollstuhltechnik.de