

	Kg.
	cm.

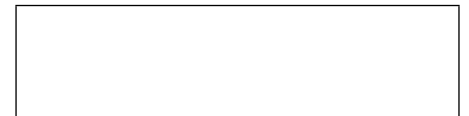

PC & Macbook
<https://get.adobe.com/uk/reader/>

Tablet & iPad
<https://www.adobe.com/acrobat/mobile.html>

ENG

DE

FR

DK

FAUTEUIL ROULANT SUR MESURE

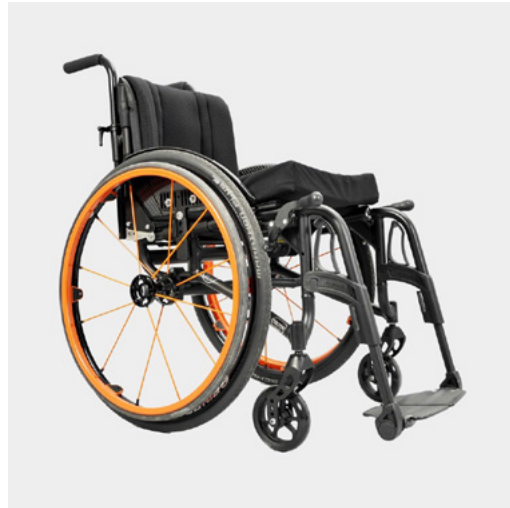

11100000500? £ 3849			WO06
14100000190? £ 3589			WO15

619000001009			
619000001109			
619000001209			
619000001309			
619000001409			
619000001509			
619000002109			
619000002509			
619000002609			
619000002809			
619000003309			
619000003409			
619000003509			
619000003609			
619000003009 £ 502		FC01	
000000001102 500000000200 £ 95		(1st drawing FOC)	

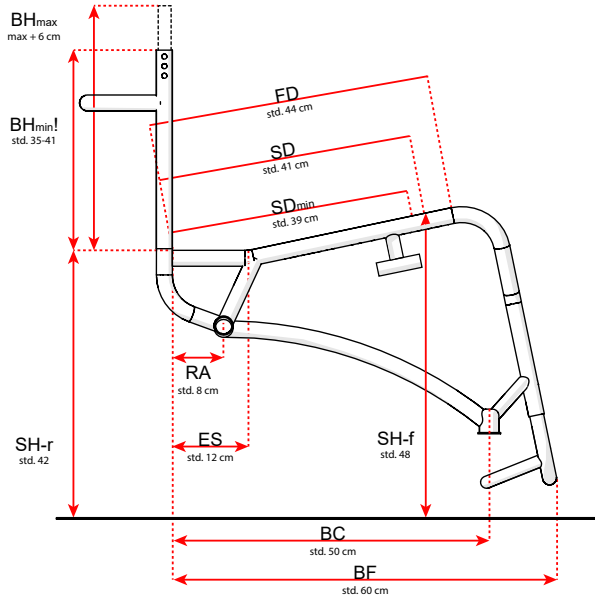

	!		SW: _____ cm
	!		FD: _____ cm
			SD: _____ cm
			SD-min: _____ cm
	!		SH-r _____ cm
	!		SH-f: _____ cm
	!		C: _____ °
			BH: _____ cm
	!		BH-d: _____ cm
			BH-max: _____ cm
			BH-min: _____ cm
			RA: _____ cm
69100001010? £ 509		AC50	HRA: _____ cm
610000001009 £ 0			
610000??0001 £ 0	!		ES: _____ cm
			BF: _____ cm
			BC: _____ cm
			CW: _____ cm
			TW: _____ cm

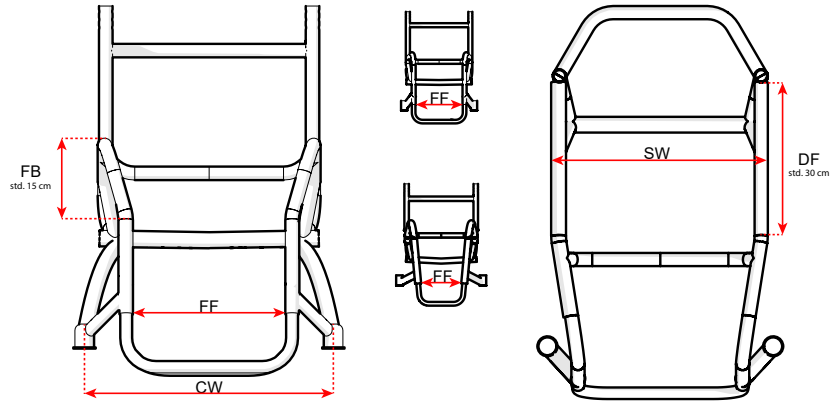

Fill in and send to Wolturnus - Ausfüllen und an Wolturnus senden - Udfyld og send til Wolturnus

Subject to Technical Modifications and Printing Errors / Technische Änderungen und Druckfehler vorbehalten
Forbehold for tekniske ændringer og trykfejl

	!			FF: _____ cm	
	!			FB: _____ cm	
				FF: _____ cm	
				DF: _____ cm	
				FF: _____ cm	

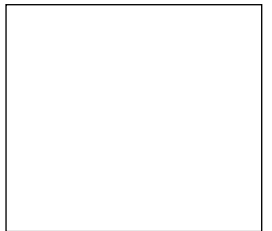
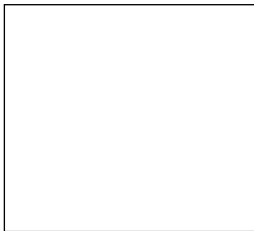

8861101013?? £ 224	!		AC51			
8861101013?? £ 224			AC51			
					AF: _____ cm	
					AW: _____ cm	
886110102001 £ 224						AC52

© Wolturnus A/S WSSL / Dalton Light EN-DE-FR-DA 2022 v2.0



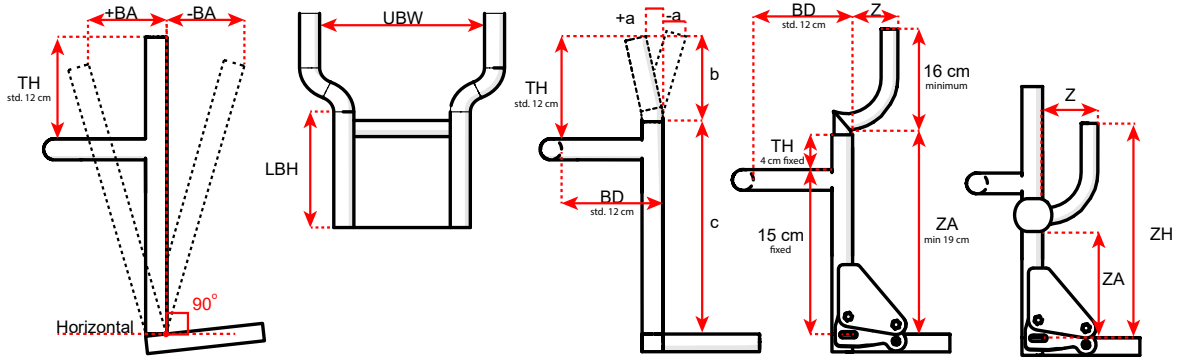

813100050???				
£ 0				
813100051???				
£ 255			BC50	BA: _____ ±cm
691000010130				
£ 47			BC51	
813100053???				
£ 345			BC52	
	!			SW-s: _____ cm

81220020000?				UBW: _____ cm
£ 170			BC53	LBH: _____ cm

812200200020				a: _____ cm
£ 100				b: _____ cm
			BC54	c: _____ cm

	!			BD: _____ cm
				TH: _____ cm

8122002001??				
£ 386			BC58	!
8122002001??				
£ 498				
82501000????			BC60	_____ cm
£ 386				ZA: _____ cm
8122002001??				
£ 640			BC57	Z: _____ cm
8122002001??				ZH: _____ cm
£ 640				

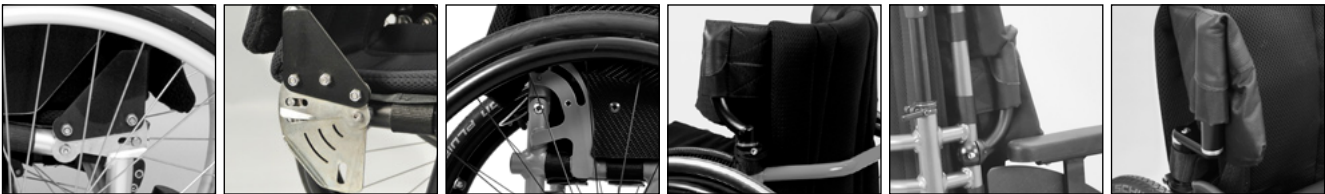

--	--

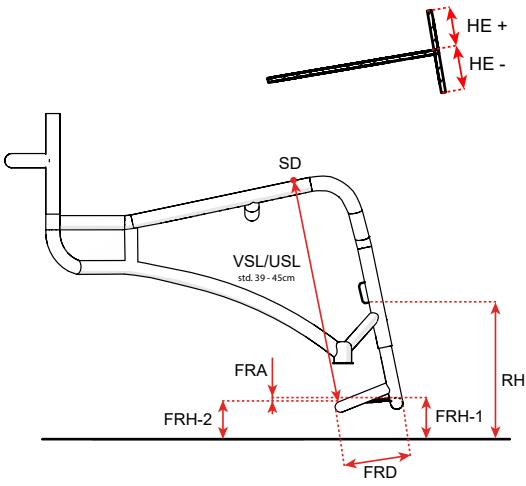

				VSL/USL: _____ cm
				FRH-1: _____ cm
				FRH-2: _____ cm
				-1,5 -3 +1,5 +3
8200FF00FR00 £ 0				FP50
82??99000000 £ 220			FP51	Custom FRD _____ cm
829999020004 £ 263			FP52	HE: _____ ±cm
8299990000?9 £ 0				FRD: _____ cm FRA: _____ cm FRD std. 12 cm FRA std. 1 cm
8299990100?1 £ 189		FP53		
8299990100?5 £ 155		FP54		
8299990100?3 £ 363		FP55		
8400100001?? £ 0				
829999020090 £ 159				FP56
835099210001 £ 47		!		FR50
829999012001 £ 24				FR51 HE: _____ ±cm
				FRP: _____ cm
691000010001 £ 47				FR52 RH: _____ cm







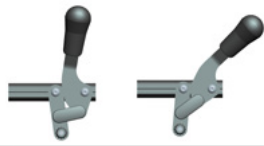
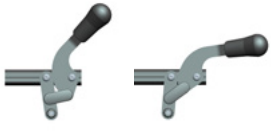
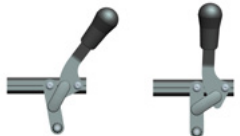

--	--

761000000010 £ 170						1+ 2+ 3+ 4+ 5+
						+0 1+ 2+ 3+ 4+ 5+
						BU50

710000000001 £ 0						
710099990010 £ 299		BU51				
710099990012 £ 325		BU52				
710099990013 £ 325		BU53				
710099990011 £ 325		BU54				

710099990001 £ 0						
710099990003 £ 129		BU55				
710099990004 £ 129		BU56				
710099990002 £ 129		BU57				
710099990000 £ 0						

750000009000 £ 186				!	AC55
- £ 0				_____ cm / _____ cm	
750000000005 £ 47	!	AC56		5cm Std.	7cm
				Medium Std.	Hard

885110101001 £ 0			
885110101003 £ 0			
885110111001 £ 139		WL50	
885110122002 £ 43		WL51	
88511012200? £ 86		WL52	
885110201009 £ 108		WL53	
885110200909 £ 139		WL54	
885110101101 £ 139		WL55	
885110111101 £ 139		WL56	
951519204000 £ 62 £ 124			WL57 WL58
885110201209 £ 155		WL59	
885110201300 £ 178		WL60	
85511020130? £ 286		WL61	
951500020019 £ 51		WL64	
691000020001 £ 116		WL62	

				
881000100003 £ 0				
881000600003 £ 0				
881000?0000 £ 236 SG50				
88100010000? £ 236 SG51				
88100040000? £ 178 SG52				
88100050000? £ 495 SG53				
88100020000? £ 520 SG54				
88100030000? £ 579 SG55				

883124101014 £ 172			SG56
681000010002 £ 47			SG57
681000010052 £ 47			SG58
7670000000?? £ 120			SG59

	GH:	_____ cm
	GL:	_____ cm
	MC:	_____ cm

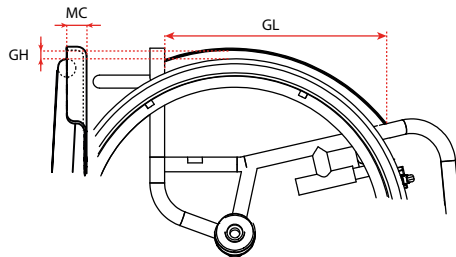



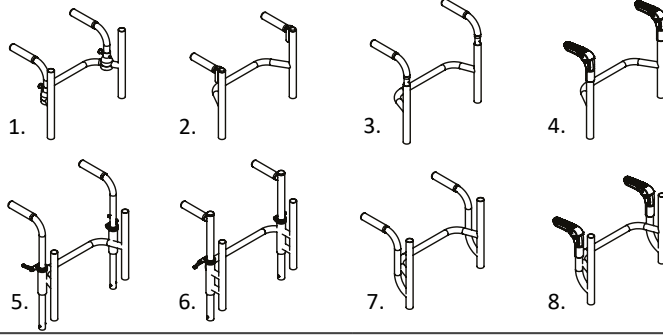





--	--



81310005??09 £ 228	1.	PH50
81310005?106 £ 220	2.	PH51
81310005?206 £ 255		PH52
81310005?108 £ 220	3.	PH53
81310005?208 £ 255		PH54
81310005?107 £ 128	4.	PH55
81310005?207 £ 159		PH56
81310005??02 £ 359	5.	PH57
81310005??03 £ 359	6.	PH58
81310005??04 £ 255	7.	PH59
81310005??05 £ 399	8.	PH60



PH: _____ cm

69100002002? £ 193	AC57	
886210101001 £ 236	AC58	
7600000100?? £ 47 £ 43	AC59 AC60	
76100000000? £ 112 £ 159	AC61 AC62	
771100000??? £ 74 £ 78 £ 85	AC63 AC64 AC65	
771100000747 £ 70	AC66	
953001040120 £ 74		AC67

966401253410		£ 58		CA55
966401003410		£ 58		CA56
966401253400		£ 0		CA88
966401003400		£ 0		
966401003403		£ 0		
966401003402		£ 0		
966401003401		£ 0		
966401003404		£ 0		
860020000000		£ 41		
966401250120		£ 95		CA62
966401250220		£ 95		CA63
966401250320		£ 95		CA64
966401250820		£ 95		CA65
966401250020		£ 95		CA66
966401000120		£ 95		CA67
966401000220		£ 95		CA68
966401000320		£ 95		CA69
966401000820		£ 95		CA70
966401000020		£ 95		CA71
966401250720		£ 129		CA72
966401250620		£ 129		CA73
966401250520		£ 129		CA74
966401250420		£ 129		CA75
966401000720		£ 129		CA76
966401000620		£ 129		CA77
966401000520		£ 129		CA78
966401000420		£ 129		CA79
		£ 0		

--	--

	22"	24"	25"	26"		
85102??01009					£ 0	
85102?10100?	-			-	£ 0	
8510??101002				-	£ 178	RW50
851124201009	-		-	-	£ 325	RW51

	22"	24"	25"	26"			
85352?101008					£ 563	RW55	
85352?101208					£ 563	RW56	
85352?101508	-				£ 563	RW57	
85352?101308					£ 563	RW58	
85352?102108					£ 563	RW59	
85352?101009					£ 455	RW60	
85352?101209					£ 455	RW61	
85352?101509	-				£ 455	RW62	
85352?101309					£ 455	RW63	
85352?101?09					£ 455	RW64	

85352?101608					£ 640	RW65	
85352?101408	-			-	£ 640	RW66	
85352?101808					£ 640	RW67	
85352?101708					£ 640	RW68	
85362?241008					£ 640	RW69	
85362?241208	-				£ 640	RW70	
85362?241508					£ 640	RW71	
85362?241308					£ 640	RW72	
85362?181008					£ 640	RW73	
85362?181208	-				£ 640	RW74	
85362?181508					£ 640	RW75	
85362?181308					£ 640	RW76	

--	--

	22"	24"	25"	26"		
9662????00??				-	£ 0	
96622?01000?					£ 48	TY50
96622?010009					£ 102	TY51
96622?010001	-				£ 0	
966224010011	-		-	-	£ 0	
966224010012	-		-	-	£ 0	
966224010007	-		-	-	£ 48	TY53
96622?230010	-				£ 94	TY54

85512?10200?					£ 0	
85512?102008	-			-	£ 135	PR50
840000215694	-		-	-	£ 62	PR51
85502?103009	-				£ 124	PR52
85552?000009					£ 347 £ 405	PR53
8554202?0601	-				£ 228	PR54
8554262?0601	-				£ 417	PR55
8554272?0601	-				£ 417	PR56
8554282?0601					£ 499	PR57
8554302?0601					£ 499	PR58
8554502?060?	-			-	£ 499	PR59
8554502?060?	-			-	£ 499	PR60

85712?102009					£ 124	AC68
--------------	--	--	--	--	-------	------

--	--	--	--	--	--	--

--	--	--	--	--	--	--

P.4	
P.5	
P.6	
P.7	
P.9	
P.10	
P.11	
P.12	
P.13	
P.14	

Fill in and send to Wolturnus - Ausfüllen und an Wolturnus senden - Udfyld og send til Wolturnus

Subject to Technical Modifications and Printing Errors / Technische Änderungen und Druckfehler vorbehalten
Forbehold for tekniske ændringer og trykfejl

© Wolturnus A/S WSSL / Dalton Light EN-DE-FR-DA 2022 v2.0

