

Tailor-made Wheelchair

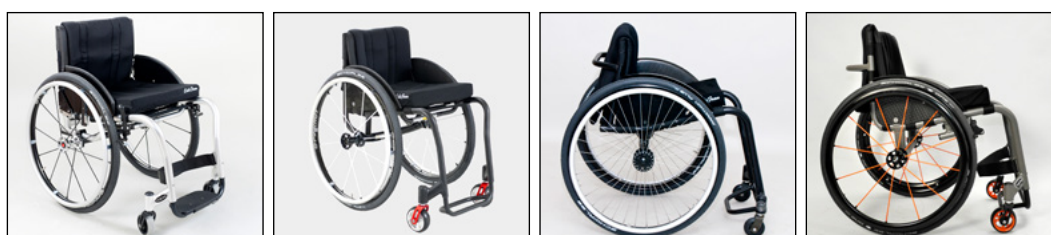

11100000100? £ 3239		
11100000300? £ 3239		
11100000400? £ 3239		
11100000200? £ 3239		
11100000550? £ 3849		
120000001500 £ 3239		
120000002000 £ 3239		
120000003000 £ 3239		
120000004000 £ 3239		
14100000150? £ 3275		WO11
14100000160? £ 3275		WO12
14100000170? £ 4045		WO13

619000001009			
619000001109			
619000001209			
619000001309			
619000001409			
619000001509			
619000002109			
619000002509			
619000002609			
619000002809			
619000003309			
619000003409			
619000003509			
619000003609			
619000003009 £ 502		FC01	
000000001102 500000000200 £ 95		(1st Drawing FOC)	

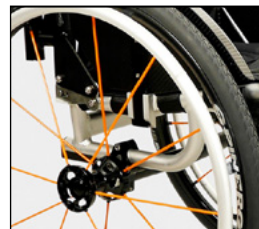
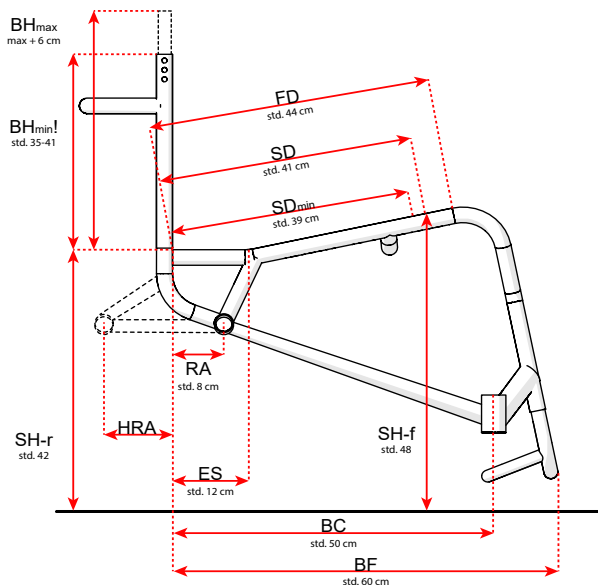

	!		SW: _____ cm
	!		FD: _____ cm
			SD: _____ cm
			SD-min: _____ cm
	!		SH-r _____ cm
	!		SH-f: _____ cm
	!		C: _____ °
			BH: _____ cm
	!		BH-d: _____ cm
			BH-max: _____ cm
			BH-min: _____ cm
			RA: _____ cm
69100001010? £ 509		AC50	HRA: _____ cm
610000001009 £ 0			
610000??0001 £ 0	!		ES: _____ cm
			BF: _____ cm
			BC: _____ cm
			CW: _____ cm
			TW: _____ cm

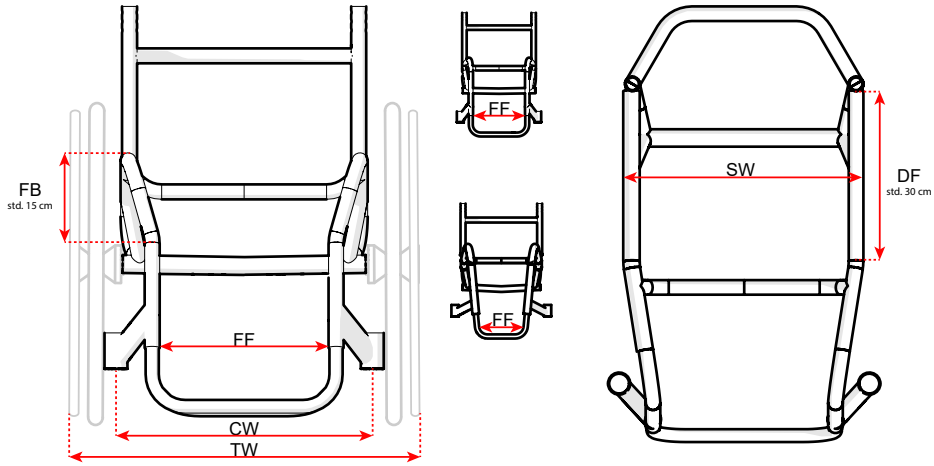

Fill in and send to Wolturnus - Ausfüllen und an Wolturnus senden - Udfyld og send til Wolturnus

Subject to Technical Modifications and Printing Errors / Technische Änderungen und Druckfehler vorbehalten
Forbehold for tekniske ændringer og trykfejl

	!								FF: _____ cm
									FB: _____ cm
	!								FF: _____ cm
									DF: _____ cm
									FF: _____ cm

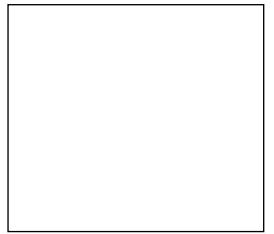
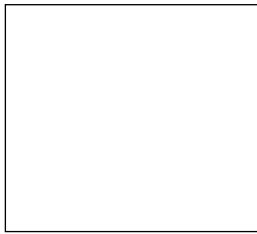

8861101013?? £ 224									
8861101013?? £ 224					AC51				
8861101013?? £ 299					AC52				
8861101013?? £ 299					AC53				
					AC53				
	!								AF: _____ cm
									AW: _____ cm
886110102001 £ 224									AC52

© Wolturnus A/S W5Tukan/Dalton Winter 2022 v1.2



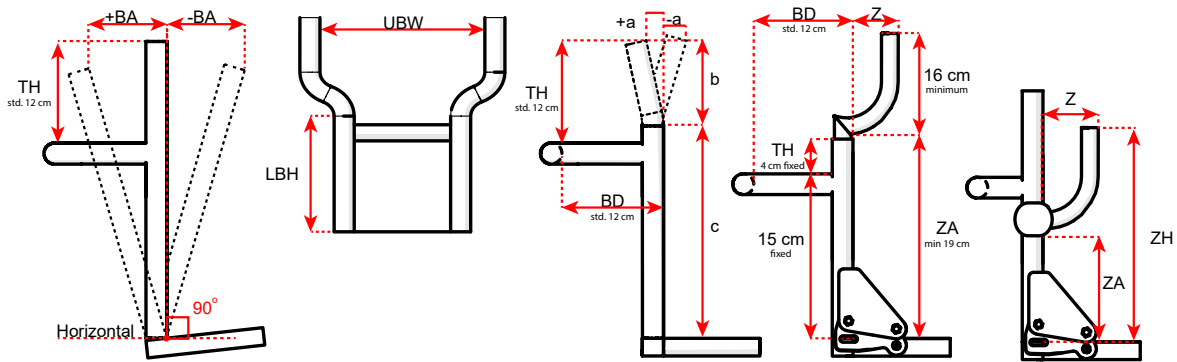

813100050???				
£ 0				
813100051???				
£ 255				
691000010130			BC50	BA: _____ ±cm
£ 47			BC51	
813100053???			BC52	
£ 345	!			SW-s: _____ cm

81220020000?				UBW: _____ cm
£ 170			BC53	LBH: _____ cm

812200200020				a: _____ cm
£ 100				b: _____ cm
			BC54	c: _____ cm

	!			BD: _____ cm
				TH: _____ cm

8122002001??				
£ 386			BC58	
8122002001??				
£ 498				
82501000????			BC60	_____ cm
£ 386	!			ZA: _____ cm
8122002001??			BC57	Z: _____ cm
£ 640				ZH: _____ cm
8122002001??				
£ 640				

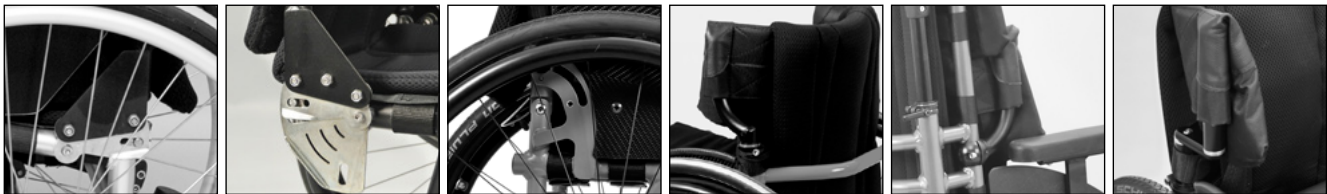

--	--

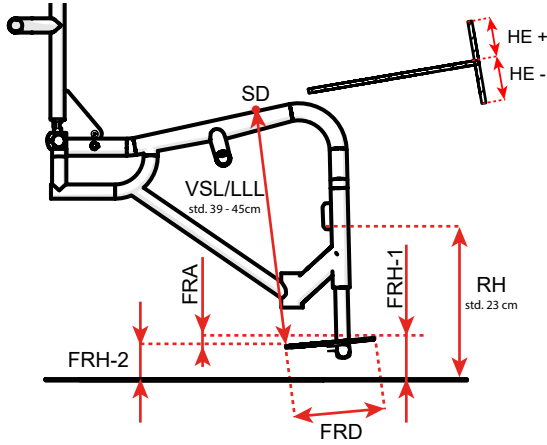

		VSL/USL: _____ cm
		FRH-1: _____ cm
		FRH-2: _____ cm

		-1,5 -3 +1,5 +3
--	--	------------------------

8200FF00FR00 £ 0		
82??99000000 £ 100		
829999020004 £ 220		Custom FRD _____ cm
829999020004 £ 263		HE: _____ ±cm

8299990000?9 £ 0			
8299990100?1 £ 189			FRD: _____ cm
8299990100?5 £ 155			FRA: _____ cm
8299990100?3 £ 363			FRD std. 12 cm FRA std. 1 cm
829999200005 £ 0			
835050001001 £ 1346			FP57

829999020090 £ 159			
835099210001 £ 47	!		FR50
829999012001 £ 24			HE: _____ ±cm
			FRP: _____ cm
691000010001 £ 47			RH: _____ cm
825000000003 £ 85			
840710001010 £ 599			FreeWheel ^(sm) Wheelchair Attachment

--	--	--	--

Fill in and send to Wolturnus - Ausfüllen und an Wolturnus senden - Udfyld og send til Wolturnus

Subject to Technical Modifications and Printing Errors / Technische Änderungen und Druckfehler vorbehalten
Forbehold for tekniske ændringer og trykfejl







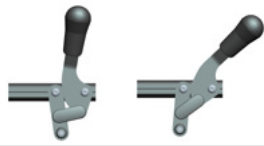

© Wolturnus A/S W5Tukan/Dalton Winter 2022 v1.2

761000000010 £ 170												
							1+	2+	3+	4+	5+	
							+0	1+	2+	3+	4+	5+
												BU50

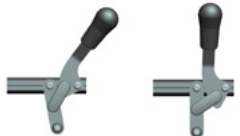
710000000001 £ 0												
710099990010 £ 299											BU51	
710099990012 £ 325											BU52	
710099990013 £ 325											BU53	
710099990011 £ 325											BU54	

710099990001 £ 0												
710099990003 £ 129											BU55	
710099990004 £ 129											BU56	
710099990002 £ 129											BU57	
710099990000 £ 0												

750000009000 £ 186												!	AC55
- £ 0													_____ cm / _____ cm
750000000005 £ 47		!											5cm Std. 7cm
					AC56								Medium Std. Hard

885110101001 £ 0			
885110101003 £ 0			
885110111001 £ 139		WL50	
885110122002 £ 43		WL51	
88511012200? £ 86		WL52	
885110201009 £ 108		WL53	
885110200909 £ 139		WL54	
885110101101 £ 139		WL55	
885110111101 £ 139		WL56	
951519204000 £ 62 £ 124			WL57 WL58
885110201209 £ 155		WL59	
885110201300 £ 225		WL60	
85511020130? £ 365			
8400002072XX £ 313			WL63
951500020019 £ 51		WL64	
951519300007 £ 51		WL65	
691000020001 £ 116			

				
881000100003 £ 0				
881000600003 £ 0				
881000?0000 £ 236 SG50				
88100010000? £ 236 SG51				
88100040000? £ 178 SG52				
88100050000? £ 495 SG53				
88100020000? £ 520 SG54				
88100030000? £ 579 SG55				



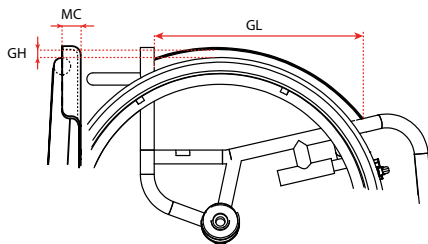

883124101014 £ 170			SG56
681000010002 £ 47			SG57
681000010052 £ 47			SG58
76700000000?? £ 120			SG59

	GH: _____ cm
	GL: _____ cm
	MC: _____ cm

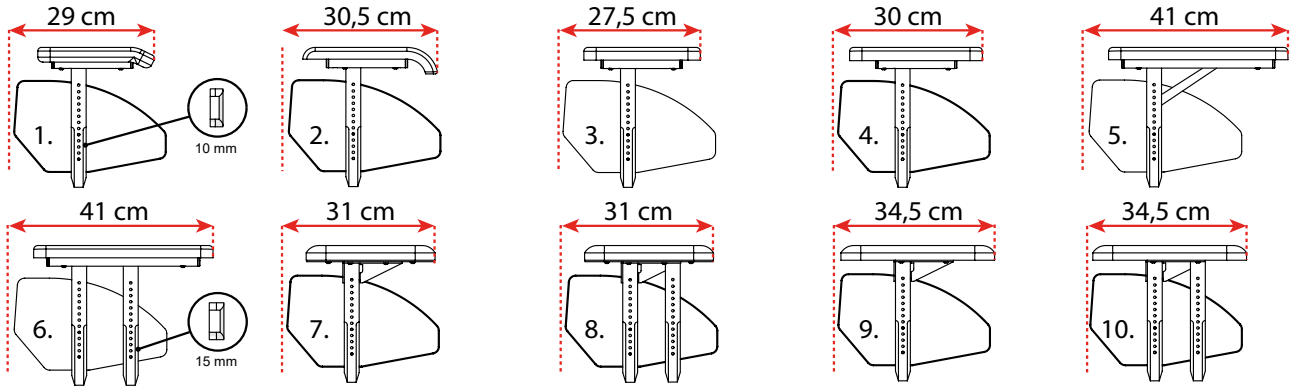

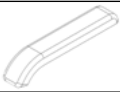
--	--

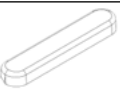
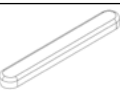
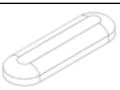
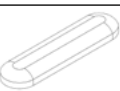

881001000003 £ 378		SG60	AB = 29 cm AL = 23,5 cm	
881001100003 £ 390		SG61	AB = 30,5 cm AL = 27,5 cm	
881001200003 £ 378		SG62	AB = 27,5 cm AL = 23,5 cm	
881001300003 £ 399		SG63	AB = 30 cm AL = 27 cm	
881001?00003 £ 571 £ 675		SG64 SG65	AB = 41 cm AL = 37 cm	
881001?00003 £ 621 £ 706		SG66 SG67	AB = 31 cm AL = 26 cm	
881001?00003 £ 621 £ 706		SG68 SG69	AB = 34,5 cm AL = 31 cm	
681000010004 £ 120				 SG70
681000010007 £ 66				SG71
883124101002 £ 382			AL: _____ cm	SG72
	!		AS: _____ cm	

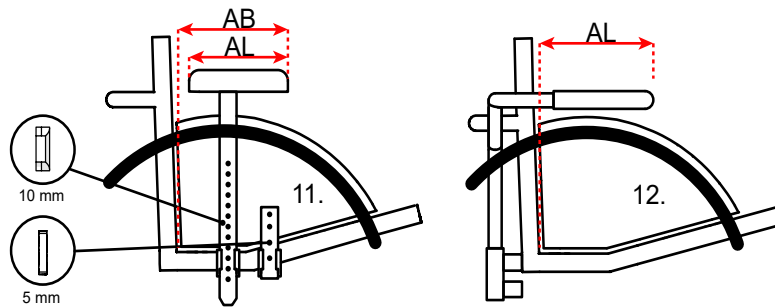

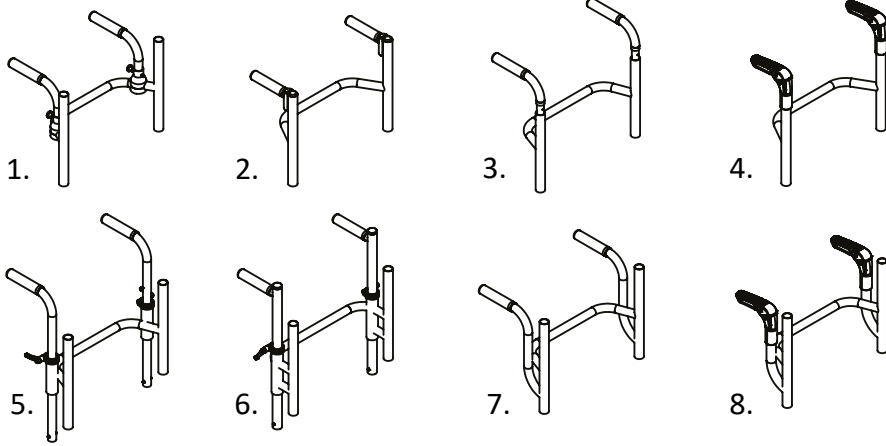





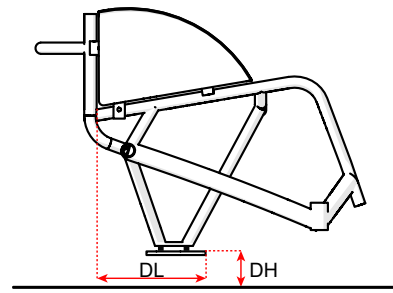
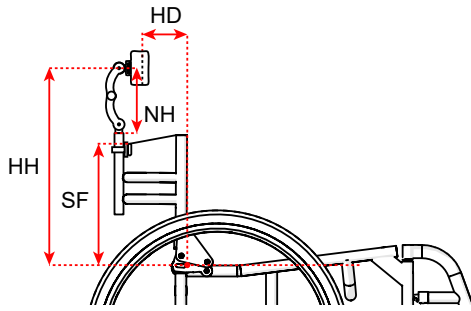

81310005??09 £ 228	1.		PH50
81310005?106 £ 220	2.		PH51
81310005?206 £ 255			PH52
81310005?108 £ 220	3.		PH53
81310005?208 £ 255			PH54
81310005?107 £ 128	4.		PH55
81310005?207 £ 159			PH56
81310005??02 £ 359	5.		PH57
81310005??03 £ 359	6.		PH58
81310005??04 £ 255	7.		PH59
81310005??05 £ 399	8.		PH60
			PH: _____ cm









--	--



884100013001 £ 166					HS50
884100014001 £ 240					HS51
951000080130 £ 62			HS52		NH: _____ cm
951000080131 £ 78			HS53		
951000080141 £ 78			HS54		HH: _____ cm
840000100831 £ 78			HS55		
840000100832 £ 124					HS60
840000100011 £ 145					HS59
884100250100 £ 132					HS58 SF: _____ cm

825000000001 £ 205					
887000200000? £ 344					CF50
887000200011 £ 1666					DL: _____ cm DH: _____ cm CF51

69100002002? £ 193			AC57		
886210101001 £ 236			AC58		
7600000100?? £ 47 £ 43			AC59 AC60		
76100000000? £ 112 £ 159			AC61 AC62		
7711000007?? £ 74 £ 78 £ 85			AC63 AC64 AC65		
771100000747 £ 70			AC66		
953001040120 £ 74					AC67

860010201251	£ 0	Std.	LED
860010201000	£ 0		
860010201001	£ 0		
860010200801	£ 0		
860010101401	£ 0	29mm	40mm
860010101253	£ 0		
860010101251	£ 0		
860010101002	£ 0		
860010200910	£ 124	CA57	
860010200900	£ 124	CA58	
8600101015??	£ 305	CA59	
8600101015??	£ 305	CA60	
86001010201?	£ 0		CA88
	£ 0		
	£ 0		
8600101020??	£ 0		
	£ 0		
860020000000	£ 35		
86001020150?	£ 195		CA50
	£ 195		CA51
860010201???	£ 195		
	£ 195		
	£ 195		
	£ 195		CA52
860010201???	£ 195		
	£ 195		
	£ 195		
	£ 195		
	£ 195		
860010201???	£ 240		CA53
	£ 240		
	£ 240		
	£ 240		
860010201???	£ 240		CA54
	£ 240		
	£ 240		
	£ 240		
	£ 240		
	£ 0		
	£ 116		
	£ 116		
	£ 116		
885201001001	£ 425		CA89
862400001009	£ 216		CA90

	22"	24"	25"	26"		
85102??01009					£ 0	
85102?10100?	-			-	£ 0	
8510??101002				-	£ 178	RW50
851124201009	-		-	-	£ 325	RW51
853728111019 853728111020			-		£ 563	!
8537281110??			-	-	£ 895	RW54 !

	22"	24"	25"	26"		
85352?101008					£ 563	RW55
85352?101208					£ 563	RW56
85352?101508	-				£ 563	RW57
85352?101308					£ 563	RW58
85352?102108					£ 563	RW59
85352?101009					£ 455	RW60
85352?101209					£ 455	RW61
85352?101509	-				£ 455	RW62
85352?101309					£ 455	RW63
85352?101?09					£ 455	RW64

85352?101608					£ 640	RW65
85352?101408					£ 640	RW66
85352?101808	-			-	£ 640	RW67
85352?101708					£ 640	RW68
85362?241008					£ 640	RW69
85362?241208					£ 640	RW70
85362?241508	-				£ 640	RW71
85362?241308					£ 640	RW72
85362?181008					£ 640	RW73
85362?181208					£ 640	RW74
85362?181508	-				£ 640	RW75
85362?181308					£ 640	RW76

--	--

	22"	24"	25"	26"		
9662????00??				-	£ 0	
96622?01000?					£ 48	TY50
96622?010009					£ 102	TY51
96622?010001	-				£ 0	
966224010011	-		-	-	£ 0	
966224010012	-		-	-	£ 0	
966224010007	-		-	-	£ 48	TY53
96622?230010	-				£ 96	TY54

85512?10200?					£ 0	
85512?102008	-			-	£ 135	PR50
840000215694	-		-	-	£ 62	PR51
85502?103009	-				£ 124	PR52
85552?000009					£ 347 £ 405	PR53
8554202?0601	-				£ 228	PR54
8554262?0601	-				£ 417	PR55
8554272?0601	-				£ 417	PR56
8554282?0601					£ 499	PR57
8554302?0601					£ 499	PR58
8554502?060?	-			-	£ 499	PR59
8554502?060?	-			-	£ 499	PR60

			!			

85712?102009					£ 124	AC68
--------------	--	--	--	--	-------	------

--	--	--	--	--	--	--

853728111062				£ 428	 ES50
853728111061				£ 428	 ES51
853727110001				£ 895	
853727110001				£ 895	
853727110002				£ 895	
853727110002				£ 895	
853728111?65				£ 66	 ES56
853727110003				£ 895	
853727110004				£ 895	
853727110005				£ 895	
853727110007				£ 895	
951099250460				£ 143	
951099250560				£ 143	ES62
853728120000				£ 162	 ES63

£ 0					JB: _____ cm JA: _____ cm AJB: _____ cm AJA: _____ cm

825000000007 £ 78				ES64	CTP: _____ cm CTD: _____ cm

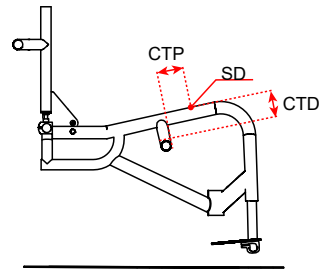
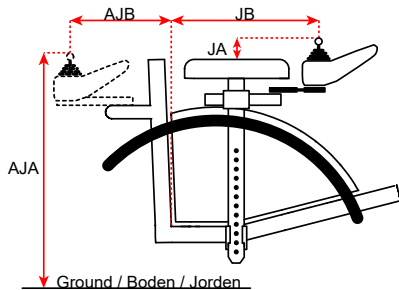

P.4	
P.5	
P.6	
P.7	
P.9	
P.10	
P.11	
P.12	
P.13	
P.14	
P.15	
P.16	

